



# OPERATOR'S MANUAL

Metal Working



Book 1 of 2

## PLASMA CUTTING TABLE MODEL: PT-48AH-W

Baileigh Industrial Holdings LLC  
P.O. Box 531  
Manitowoc, WI 54221-0531  
Phone: 920.684.4990  
Fax: 920.684.3944  
[sales@baileigh.com](mailto:sales@baileigh.com)

REPRODUCTION OF THIS MANUAL IN ANY FORM WITHOUT WRITTEN APPROVAL OF BAILEIGH INDUSTRIAL HOLDINGS LLC IS PROHIBITED. Baileigh Industrial Holdings LLC, Inc. does not assume and hereby disclaims any liability for any damage or loss caused by an omission or error in this Operator's Manual, resulting from accident, negligence, or other occurrence.

Rev. 07/2019



## Table of Contents

THANK YOU & WARRANTY .....	1
INTRODUCTION.....	3
GENERAL NOTES.....	3
SAFETY INSTRUCTIONS .....	4
SAFETY PRECAUTIONS .....	7
Dear Valued Customer:.....	7
TECHNICAL SPECIFICATIONS .....	10
TECHNICAL SUPPORT .....	10
UNPACKING AND CHECKING CONTENTS.....	11
Cleaning .....	11
TRANSPORTING AND LIFTING .....	12
INSTALLATION.....	13
GETTING TO KNOW YOUR MACHINE .....	14
ASSEMBLY AND SET UP .....	15
Torch Mounting.....	16
Torch Cable Routing.....	17
Water Fill .....	20
ELECTRICAL.....	21
Cord and Power Connection .....	22
PLASMA CUTTER WIRE CONNECTIONS .....	23
SOFTWARE.....	24
Ohmic Clip Connection.....	25
PLASMA TABLE START-UP PROCEDURE .....	27
GENERAL PLASMA TABLE INFORMATION .....	28
The Plasma Systems.....	28
BASIC / QUICK CONTROLLER OPERATION.....	31
General Commands .....	31
General Operation Steps.....	32
Plasma Cutting Mode Type .....	37
CUTTING PARAMETER PROCEDURE .....	38
Cutting Height.....	39
Arc Voltage.....	39
LUBRICATION AND MAINTENANCE .....	40
ELECTRICAL DIAGRAM .....	41
SOFTWARE INFORMATION.....	42
BobCAD-CAM Contacts:.....	42
PT-48AH-W QUICK REFERENCE GUIDE .....	45



## THANK YOU & WARRANTY

Thank you for your purchase of a machine from Baileigh Industrial Holdings LLC. We hope that you find it productive and useful to you for a long time to come.

**Inspection & Acceptance.** Buyer shall inspect all Goods within ten (10) days after receipt thereof. Buyer's payment shall constitute final acceptance of the Goods and shall act as a waiver of the Buyer's rights to inspect or reject the goods unless otherwise agreed. If Buyer rejects any merchandise, Buyer must first obtain a Returned Goods Authorization ("RGA") number before returning any goods to Seller. Goods returned without a RGA will be refused. Seller will not be responsible for any freight costs, damages to goods, or any other costs or liabilities pertaining to goods returned without a RGA. Seller shall have the right to substitute a conforming tender. Buyer will be responsible for all freight costs to and from Buyer and repackaging costs, if any, if Buyer refuses to accept shipment. If Goods are returned in unsalable condition, Buyer shall be responsible for full value of the Goods. Buyer may not return any special-order Goods. Any Goods returned hereunder shall be subject to a restocking fee equal to 30% of the invoice price.

**Specifications.** Seller may, at its option, make changes in the designs, specifications or components of the Goods to improve the safety of such Goods, or if in Seller's judgment, such changes will be beneficial to their operation or use. Buyer may not make any changes in the specifications for the Goods unless Seller approves of such changes in writing, in which event Seller may impose additional charges to implement such changes.

**Limited Warranty.** Seller warrants to the original end-user that the Goods manufactured or provided by Seller under this Agreement shall be free of defects in material or workmanship for a period of twelve (12) months from the date of purchase, provided that the Goods are installed, used, and maintained in accordance with any instruction manual or technical guidelines provided by the Seller or supplied with the Goods, if applicable. The original end-user must give written notice to Seller of any suspected defect in the Goods prior to the expiration of the warranty period. The original end-user must also obtain a RGA from Seller prior to returning any Goods to Seller for warranty service under this paragraph. Seller will not accept any responsibility for Goods returned without a RGA. The original end-user shall be responsible for all costs and expenses associated with returning the Goods to Seller for warranty service. In the event of a defect, Seller, at its sole option, shall repair or replace the defective Goods or refund to the original end-user the purchase price for such defective Goods. Goods are not eligible for replacement or return after a period of 10 days from date of receipt. The foregoing warranty is Seller's sole obligation, and the original end-user's exclusive remedy, with regard to any defective Goods. This limited warranty does not apply to: (a) die sets, tooling, and saw blades; (b) periodic or routine maintenance and setup, (c) repair or replacement of the Goods due to normal wear and tear, (d) defects or damage to the Goods resulting from misuse, abuse, neglect, or accidents, (e) defects or damage to the Goods resulting from improper or unauthorized alterations, modifications, or changes; and (f) any Goods that has not been installed and/or maintained in accordance with the instruction manual or technical guidelines provided by Seller.

**EXCLUSION OF OTHER WARRANTIES.** THE FOREGOING LIMITED WARRANTY IS IN LIEU OF ALL OTHER WARRANTIES, EXPRESS OR IMPLIED. ANY AND ALL OTHER EXPRESS, STATUTORY OR IMPLIED WARRANTIES, INCLUDING BUT NOT LIMITED TO, ANY WARRANTY OF MERCHANTABILITY OR FITNESS FOR ANY PARTICULAR PURPOSE ARE EXPRESSLY DISCLAIMED. NO WARRANTY IS MADE WHICH EXTENDS BEYOND THAT WHICH IS EXPRESSLY CONTAINED HEREIN.

**Limitation of Liability.** IN NO EVENT SHALL SELLER BE LIABLE TO BUYER OR ANY OTHER PARTY FOR ANY INCIDENTAL, CONSEQUENTIAL OR SPECIAL DAMAGES (INCLUDING, WITHOUT LIMITATION, LOST PROFITS OR DOWN TIME) ARISING FROM OR IN MANNER CONNECTED WITH THE GOODS, ANY BREACH BY SELLER OR ITS AGENTS OF THIS AGREEMENT, OR ANY OTHER CAUSE WHATSOEVER, WHETHER BASED ON CONTRACT, TORT OR ANY OTHER THEORY OF LIABILITY. BUYER'S REMEDY WITH RESPECT TO ANY CLAIM ARISING UNDER THIS AGREEMENT IS STRICTLY LIMITED TO NO MORE THAN THE AMOUNT PAID BY THE BUYER FOR THE GOODS.



**Force Majeure.** Seller shall not be responsible for any delay in the delivery of, or failure to deliver, Goods due to causes beyond Seller's reasonable control including, without limitation, acts of God, acts of war or terrorism, enemy actions, hostilities, strikes, labor difficulties, embargoes, non-delivery or late delivery of materials, parts and equipment or transportation delays not caused by the fault of Seller, delays caused by civil authorities, governmental regulations or orders, fire, lightening, natural disasters or any other cause beyond Seller's reasonable control. In the event of any such delay, performance will be postponed by such length of time as may be reasonably necessary to compensate for the delay.

**Installation.** If Buyer purchases any Goods that require installation, Buyer shall, at its expense, make all arrangements and connections necessary to install and operate the Goods. Buyer shall install the Goods in accordance with any Seller instructions and shall indemnify Seller against any and all damages, demands, suits, causes of action, claims and expenses (including actual attorneys' fees and costs) arising directly or indirectly out of Buyer's failure to properly install the Goods.

**Work By Others; Safety Devices.** Unless agreed to in writing by Seller, Seller has no responsibility for labor or work performed by Buyer or others, of any nature, relating to design, manufacture, fabrication, use, installation or provision of Goods. Buyer is solely responsible for furnishing, and requiring its employees and customers to use all safety devices, guards and safe operating procedures required by law and/or as set forth in manuals and instruction sheets furnished by Seller. Buyer is responsible for consulting all operator manuals, ANSI or comparable safety standards, OSHA regulations and other sources of safety standards and regulations applicable to the use and operation of the Goods.

**Remedies.** Each of the rights and remedies of Seller under this Agreement is cumulative and in addition to any other or further remedies provided under this Agreement or at law or equity.

**Attorney's Fees.** In the event legal action is necessary to recover monies due from Buyer or to enforce any provision of this Agreement, Buyer shall be liable to Seller for all costs and expenses associated therewith, including Seller's actual attorney fees and costs.

**Governing Law/Venue.** This Agreement shall be construed and governed under the laws of the State of Wisconsin, without application of conflict of law principles. Each party agrees that all actions or proceedings arising out of or in connection with this Agreement shall be commenced, tried, and litigated only in the state courts sitting in Manitowoc County, Wisconsin or the U.S. Federal Court for the Eastern District of Wisconsin. Each party waives any right it may have to assert the doctrine of "forum non conveniens" or to object to venue to the extent that any proceeding is brought in accordance with this section. Each party consents to and waives any objection to the exercise of personal jurisdiction over it by courts described in this section. Each party waives to the fullest extent permitted by applicable law the right to a trial by jury.

**Summary of Return Policy.**

- 10 Day acceptance period from date of delivery. Damage claims and order discrepancies will not be accepted after this time.
- You must obtain a Baileigh issued RGA number PRIOR to returning any materials.
- Returned materials must be received at Baileigh in new condition and in original packaging.
- Altered items are not eligible for return.
- Buyer is responsible for all shipping charges.
- A 30% re-stocking fee applies to all returns.

Baileigh Industrial Holdings LLC makes every effort to ensure that our posted specifications, images, pricing and product availability are as correct and timely as possible. We apologize for any discrepancies that may occur. Baileigh Industrial Holdings LLC reserves the right to make any and all changes deemed necessary in the course of business including but not limited to pricing, product specifications, quantities, and product availability.

**For Customer Service & Technical Support:**

Please contact one of our knowledgeable Sales and Service team members at:  
(920) 684-4990 or e-mail us at [sales@baileigh.com](mailto:sales@baileigh.com)



## **INTRODUCTION**

*The quality and reliability of the components assembled on a Baileigh Industrial Holdings LLC machine guarantee near perfect functioning, free from problems, even under the most demanding working conditions. However, if a situation arises, refer to the manual first. If a solution cannot be found, contact the distributor where you purchased our product. Make sure you have the serial number and production year of the machine (stamped on the nameplate). For replacement parts refer to the assembly numbers on the parts list drawings.*

*Our technical staff will do their best to help you get your machine back in working order.*

### **In this manual you will find: (when applicable)**

- Safety procedures
- Correct installation guidelines
- Description of the functional parts of the machine
- Capacity charts
- Setup and start-up instructions
- Machine operation
- Scheduled maintenance
- Parts lists

## **GENERAL NOTES**

After receiving your equipment remove the protective container. Do a complete visual inspection, and if damage is noted, **photograph it for insurance claims** and contact your carrier at once, requesting inspection. Also contact Baileigh Industrial Holdings LLC and inform them of the unexpected occurrence. Temporarily suspend installation.

Take necessary precautions while loading / unloading or moving the machine to avoid any injuries.

Your machine is designed and manufactured to work smoothly and efficiently. Following proper maintenance instructions will help ensure this. Try and use original spare parts, whenever possible, and most importantly; **DO NOT** overload the machine or make any modifications.



**Note:** *This symbol refers to useful information throughout the manual.*



## IMPORTANT

### PLEASE READ THIS OPERATORS MANUAL CAREFULLY

It contains important safety information, instructions, and necessary operating procedures. The continual observance of these procedures will help increase your production and extend the life of the equipment.

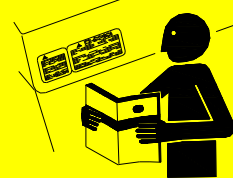

## SAFETY INSTRUCTIONS

### LEARN TO RECOGNIZE SAFETY INFORMATION

This is the safety alert symbol. When you see this symbol on your machine or in this manual, **BE ALERT TO THE POTENTIAL FOR PERSONAL INJURY!**



Follow recommended precautions and safe operating practices.

### UNDERSTAND SIGNAL WORDS

A signal word – **DANGER**, **WARNING**, or **CAUTION** – is used with the safety alert symbol. **NOTICE**, which is not related to personal injury, is used without a symbol.

**DANGER:** Indicates a hazardous situation which, if not avoided, will result in death or serious injury.

**WARNING:** Indicates a hazardous situation which, if not avoided, could result in death or serious injury.

**CAUTION:** Indicates a hazardous situation which, if not avoided, could result in minor or moderate injury.

**NOTICE:** Indicates a situation which, if not avoided, could result in property damage.



**DANGER**



**WARNING**



**CAUTION**



**NOTICE**



**SAVE THESE INSTRUCTIONS.**  
**Refer to them often and use them to instruct others.**



**PROTECT EYES**

Wear safety glasses or suitable eye protection when working on or around machinery.

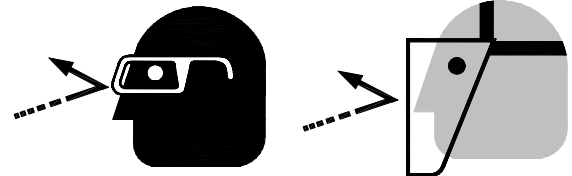

**PROTECT AGAINST NOISE**

Prolonged exposure to loud noise can cause impairment or loss of hearing. Wear suitable hearing protective devices such as ear muffs or earplugs to protect against objectionable or uncomfortable loud noises.

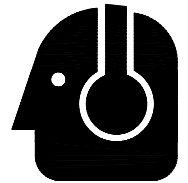

**BEWARE OF PINCH POINTS**

Keep hands and fingers away from the servo motors drive belt and pulleys when performing maintenance. Keep motor guards in place at all times while the machine is running.

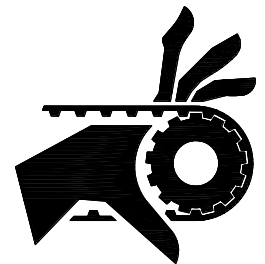

**FUMES AND GASES**

The plasma cutting process produces fumes and gases that can be hazardous to your health. If the area is not properly ventilated to remove them, use an air supplied respirator.

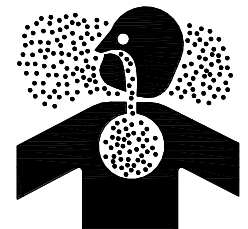

**ELECTRICAL SHOCK CAN KILL**

The plasma arc process uses and produces high voltages that can **severely injure or kill**. Disconnect power source before performing service or repairs. Insulate yourself from the piece part or other components in the weld circuit.





### ELECTRICAL AND MAGNETIC FIELDS

Electric current used with plasma cutting creates electric and magnetic fields (EMF). These magnetic fields can have an effect on pacemakers and other sensitive electronic equipment. If you wear a pacemaker or similar device contact your doctor before operating this type of equipment. Prolonged exposure to EMF may have other health effects which are not yet known.

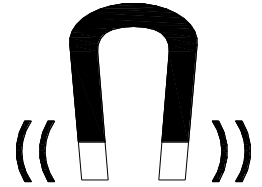

### CUTTING SPARKS

A spark or piece of hot metal can fly out of the arc while cutting. Remove all flammable materials from the plasma cutting area. Wear approved eye protection, and proper hand and body protection. Make sure the cutting tip is not grounded when sitting idle, which could cause heat buildup, resulting in a possible fire.

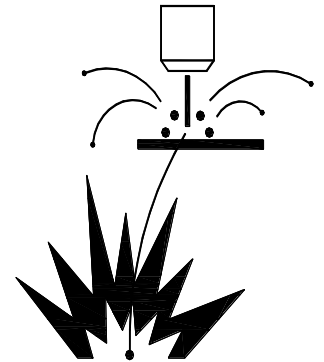

### PROTECT SKIN

Keep hands and body protected from the plasma arc and hot sparks. The heat from the plasma arc is very intense and can pierce the skin resulting in serious burns. Always wear gloves and suitable clothing. **DO NOT** touch hot piece part without gloves.

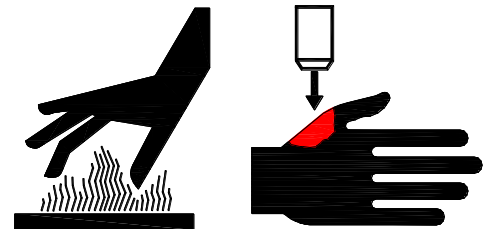

### DUST HAZARD

Wear appropriate dust mask. Dust created while using machinery can cause cancer, birth defects, and long term respiratory damage. Be aware of the dust hazards associated with all types of materials.

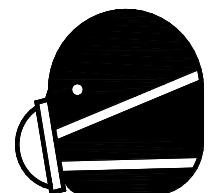





### HIGH VOLTAGE

**USE CAUTION IN HIGH VOLTAGE AREAS. DO NOT** assume the power to be off.  
**FOLLOW PROPER LOCKOUT PROCEDURES.**

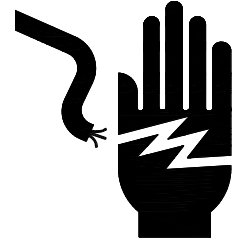

### EMERGENCY STOP BUTTON

In the event of incorrect operation or dangerous conditions, the machine can be stopped immediately by pressing the **E-STOP** button. Twist the emergency stop button clockwise (cw) to reset. Note: Resetting the E-Stop will not start the machine.



## SAFETY PRECAUTIONS



Metal working can be dangerous if safe and proper operating procedures are not followed. As with all machinery, there are certain hazards involved with the operation of the product. Using the machine with respect and caution will considerably lessen the possibility of personal injury. However, if normal safety precautions are overlooked or ignored, personal injury to the operator may result.

Safety equipment such as guards, hold-downs, safety glasses, dust masks and hearing protection can reduce your potential for injury. But even the best guard won't make up for poor judgment, carelessness or inattention. **Always use common sense** and exercise **caution** in the workshop. If a procedure feels dangerous, don't try it.

**REMEMBER: Your personal safety is your responsibility.**



**WARNING: FAILURE TO FOLLOW THESE RULES MAY RESULT IN SERIOUS PERSONAL INJURY**

### **Dear Valued Customer:**

- All Baileigh machines should be used only for their intended use.
- Baileigh does not recommend or endorse making any modifications or alterations to a Baileigh machine. Modifications or alterations to a machine may pose a substantial risk of injury to the operator or others and may do substantial damage to the machine.
- Any modifications or alterations to a Baileigh machine will invalidate the machine's warranty.









**PLEASE ENJOY YOUR BAILEIGH MACHINE! ....PLEASE ENJOY IT SAFELY!**

1. **FOR YOUR OWN SAFETY, READ INSTRUCTION MANUAL BEFORE OPERATING THE MACHINE.** Learn the machine's application and limitations as well as the specific hazards.
2. **Only trained and qualified personnel can operate this machine.**
3. **Make sure guards are in place and in proper working order before operating machinery.**
4. **Remove any adjusting tools.** Before operating the machine, make sure any adjusting tools have been removed.
5. **Keep work area clean.** Cluttered areas invite injuries.
6. **Overloading machine.** By overloading the machine, you may cause injury from flying parts. **DO NOT** exceed the specified machine capacities.
7. **Dressing material edges.** Always chamfer and deburr all sharp edges.
8. **Do not force tool.** Your machine will do a better and safer job if used as intended. **DO NOT** use inappropriate attachments in an attempt to exceed the machines rated capacity.
9. **Use the right tool for the job. DO NOT** attempt to force a small tool or attachment to do the work of a large industrial tool. **DO NOT** use a tool for a purpose for which it was not intended.
10. **Dress appropriate. DO NOT** wear loose fitting clothing or jewelry as they can be caught in moving machine parts. Protective clothing and steel toe shoes are recommended when using machinery. Wear a restrictive hair covering to contain long hair.
11. **Use eye and ear protection.** Always wear ISO approved impact safety goggles. Wear a full-face shield if you are producing metal filings.
12. **Do not overreach.** Maintain proper footing and balance at all times. **DO NOT** reach over or across a running machine.
13. **Stay alert.** Watch what you are doing and use common sense. **DO NOT** operate any tool or machine when you are tired.
14. **Check for damaged parts.** Before using any tool or machine, carefully check any part that appears damaged. Check for alignment and binding of moving parts that may affect proper machine operation.
15. **Observe work area conditions. DO NOT** use machines or power tools in damp or wet locations. Do not expose to rain. Keep work area well lighted. **DO NOT** use electrically powered tools in the presence of flammable gases or liquids.
16. **Keep children away.** Children must never be allowed in the work area. **DO NOT** let them handle machines, tools, or extension cords.
17. **Store idle equipment.** When not in use, tools must be stored in a dry location to inhibit rust. Always lock up tools and keep them out of reach of children.



18. **DO NOT operate machine if under the influence of alcohol or drugs.** Read warning labels on prescriptions. If there is any doubt, **DO NOT** operate the machine.
19. **Sparks and hot material** from cutting can easily go through small cracks and openings into adjacent areas.
20. **DO NOT** cut where the atmosphere might contain flammable dust, gas, or liquid vapors such as from gasoline.
21. Wear oil-free protective garments such as leather gloves, heavy shirt, high shoes or boots, cuffless trousers, and a cap.
22. Watch for fire and keep a fire extinguisher close by.
23. **DO NOT** touch live electrical components or parts.
24. **Turn off** power before checking, cleaning, or replacing any torch parts.
25. Be sure **all** equipment is properly installed and grounded according to national, state, and local codes.
26. Keep **all** cords dry, free from grease and oil, and protected from sparks and hot metal.
27. Inspect power and control cables periodically. Replace if damaged or bare wires are exposed. **Bare wiring can kill!**
28. **DO NOT** bypass or defeat any safety interlock systems.
29. Learn the function and controls of the controller, the torch power supply, and the provided software packages. Know the location of the **ON - OFF** switch and the **“E”- STOP** button.
30. Keep visitors a safe distance from the work area.

 <b>WARNING</b>	
	<b>GASES and FUMES</b> produced during the plasma cutting process can be dangerous and hazardous to your health.
	<b>ELECTRIC SHOCK</b> can injure or kill. The plasma arc process uses and produces high voltage electrical energy. This electrical energy can cause severe or fatal shock to the operator or others.
	<b>FIRE and EXPLOSION</b> can be caused by hot slag, sparks, or the plasma arc.
	<b>PLASMA ARC RAYS</b> can injure your eyes and burn your skin. The plasma arc process produces very bright ultra violet and infrared light.
	<b>NOISE</b> can cause permanent hearing loss. Plasma arc processes can cause noise levels to exceed safe limits.



## TECHNICAL SPECIFICATIONS

Table Dimensions (W x L x H)	82.75" x 133.5" x 40" (2015 x 2125 x 1300mm)
Cutting Area (X x Y)	60" x 101" (1524 x 2565mm)
Z Axis Travel	3.4" (86mm)
Table Working Height	19.6" (500mm)
Table Load Capacity	1" (25.4mm) Mild Steel @ 48" x 96" (1220 x 2440mm)
Cutting Capacity	Depends on Plasma System Chosen
Travel Speed	315in./min. (8000mm/min.)
Operating Control	Touch Pad w/7" LCD Screen
Drive	Stepper Motor
Power	220V, 1ph, 60hz, 8A*
Table Water Capacity	Approximately 154gal (585L)
Shipping Weight	3021lbs. (1370kg)
Shipping Dimensions (W x L x H)	90.5" x 142" x 52" (2300 x 3607 x 1321mm)

\* Does not include plasma cutter.

- Stand Alone Control Console with CNC Controller
- Single "X" Axis and Dual "Y" Axis Stepper Motors
- "Z" Axis motor to manually adjust torch height
- Shapes Library with over 40 editable predesigned shapes.
- A license to download BobCAD-CAM Express VXX (latest version) Software
- File Transfers via USB Interface (USB 2.0 compatible)

## TECHNICAL SUPPORT

Our technical support department can be reached at 920.684.4990 and asking for the support desk for purchased machines. Tech Support handles questions on machine setup, schematics, warranty issues, and individual parts needs: (other than die sets and blades).

For specific application needs or future machine purchases contact the Sales Department at: [sales@baileigh.com](mailto:sales@baileigh.com), Phone: 920.684.4990, or Fax: 920.684.3944.



**Note:** *The photos and illustrations used in this manual are representative only and may not depict the actual color, labeling or accessories and may be intended to illustrate technique only.*



**Note:** *The specifications and dimensions presented here are subject to change without prior notice due to improvements of our products.*



## UNPACKING AND CHECKING CONTENTS

Your Baileigh machine is shipped complete. Separate all parts from the packing material and check each item carefully. Make certain all items are accounted for before discarding any packing material.

**⚠ WARNING: SUFFOCATION HAZARD!** Immediately discard any plastic bags and packing materials to eliminate choking and suffocation hazards to children and animals.  
If any parts are missing, **DO NOT** place the machine into service until the missing parts are obtained and installed correctly.

### Cleaning

**⚠ WARNING: DO NOT USE** gasoline or other petroleum products to clean the machine. They have low flash points and can explode or cause fire.

**⚠ CAUTION:** When using cleaning solvents work in a well-ventilated area. Many cleaning solvents are toxic if inhaled.

Your machine may be shipped with a rustproof waxy coating and/or grease on the exposed unpainted metal surfaces. Fully and completely remove this protective coating using a degreaser or solvent cleaner. Moving items will need to be moved along their travel path to allow for cleaning the entire surface. For a more thorough cleaning, some parts will occasionally have to be removed. **DO NOT USE** acetone or brake cleaner as they may damage painted surfaces.

Follow manufacturer's label instructions when using any type of cleaning product. After cleaning, wipe unpainted metal surfaces with a light coating of quality oil or grease for protection.



**Important:** This waxy coating is **NOT** a lubricant and will cause the machine to stick and lose performance as the coating continues to dry.





## **TRANSPORTING AND LIFTING**

**NOTICE:** *Lifting and carrying operations should be carried out by skilled workers, such as a truck operator, crane operator, etc. If a crane is used to lift the machine, attach the lifting chain carefully, making sure the machine is well balanced.*

### **Follow these guidelines when lifting with truck or trolley:**

- The lift truck must be able to lift at least 1.5 – 2 times the machines gross weight.
- Make sure the machine is balanced. While transporting, avoid rough or jerky motion, and maintain a safe clearance zone around the transport area.
- Use a fork lift with sufficient lifting capacity and forks that are long enough to reach the complete width of the machine.
- Remove the securing bolts that attach the machine to the pallet.
- Approaching the machine from the side, lift the machine on the frame taking care that there are no cables or pipes in the area of the forks.
- Move the machine to the required position and lower gently to the floor.
- Level the machine so that all the supporting feet are taking the weight of the machine and no rocking is taking place.

### **Follow these guidelines when lifting crane or hoist:**

- Always lift and carry the machine with the lifting holes provided at the top of the machine.
- Use lift equipment such as straps, chains, capable of lifting 1.5 to 2 times the weight of the machine.
- Take proper precautions for handling and lifting.
- Check if the load is properly balanced by lifting it an inch or two.
- Lift the machine, avoiding sudden accelerations or quick changes of direction.
- Locate the machine where it is to be installed, and lower slowly until it touches the floor.



## INSTALLATION

### **IMPORTANT:**

Consider the following when looking for a suitable location to place the machine:

- Overall weight of the machine.
- Weight of material being processed.
- Sizes of material to be processed through the machine.
- Space needed for auxiliary stands, work tables, or other machinery.
- Clearance from walls and other obstacles.
- Maintain an adequate working area around the machine for safety.
- Have the work area well illuminated with proper lighting.
- Keep the floor free of oil and make sure it is not slippery.
- Remove scrap and waste materials regularly, and make sure the work area is free from obstructing objects.
- If long lengths of material are to be fed into the machine, make sure that they will not extend into any aisles.
- **LEVELING:** The machine should be sited on a level, concrete floor. Provisions for securing it should be in position prior to placing the machine. The accuracy of any machine depends on the precise placement of it to the mounting surface. This machine requires a solid floor such as concrete at a minimum of 4" (102mm) thick. 6" (153mm) minimum is preferred.
- **FLOOR:** This tool distributes a large amount of weight over a small area. Make certain that the floor is capable of supporting the weight of the machine, work stock, and the operator. The floor should also be a level surface. If the unit wobbles or rocks once in place, be sure to eliminate by using shims.
- This machine requires a solid floor such as concrete at a minimum of 4" (102mm) thick. 6" (153mm) minimum is preferred.
- **WORKING CLEARANCES:** Take into consideration the size of the material to be processed. Make sure that you allow enough space for you to operate the machine freely.
- **POWER SUPPLY PLACEMENT:** The power supply should be located close enough to the machine so that the power cord is not in an area where it would cause a tripping hazard. Be sure to observe all electrical codes if installing new circuits and/or outlets.



## GETTING TO KNOW YOUR MACHINE

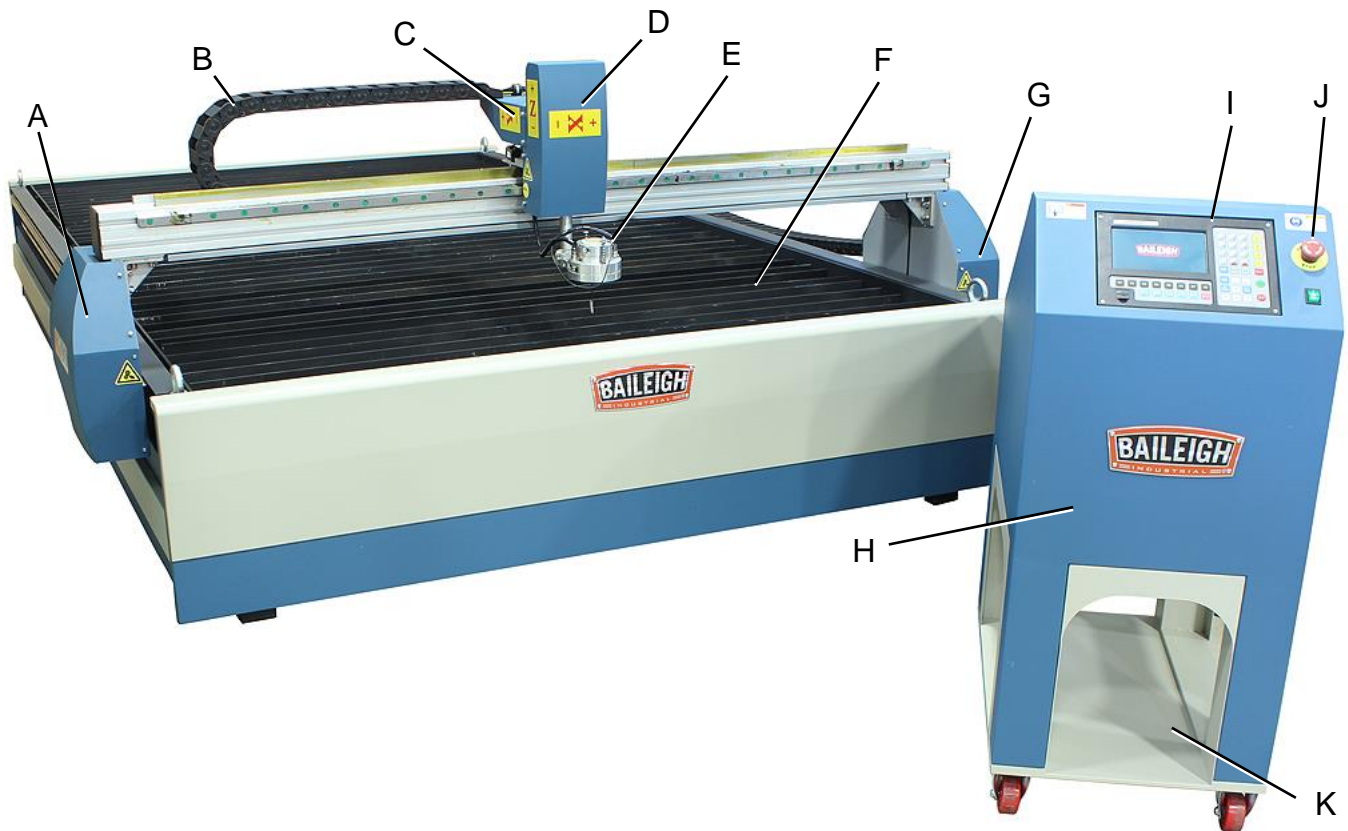

Item	Name	Description
A	"Y" axis drive (Y-1)	Consists of stepper motor, belt, and gear rack
B	"X" axis cable track	Supports and protects cables as carriage travels
C	"X" axis drive	Consists of stepper motor, belt, and gear rack
D	"Z" axis drive	Consists of stepper motor, belt, and gear rack
E	Cutting torch holder	Combines plasma and air to cut various materials
F	Material support	Used to support material when cutting
G	"Y" axis drive (Y-2)	Consists of stepper motor, belt, and gear rack
H	Control console	Houses electrical for drives
I	CNC Controller	User interface to load and run programs
J	E-Stop button	Press to stop all motion of table
K	Cutter Bay	Area to install the plasma cutter chosen to work with the table. (May not fit every option)





## ASSEMBLY AND SET UP

**⚠ WARNING:** For your own safety, **DO NOT** connect the machine to the power source until the machine is completely assembled and you read and understand the entire instruction manual.

Your Baileigh Plasma Table cutting system should include the following items:

- Welded and assembled plasma table with exhaust fan, and stepper motor drive axis system.
- Control Console with front and rear access to electrical components.
- (When ordered) Plasma cutter power supply (A) with automatic torch and the multi-conductor cable (b) for plasma start/stop, Ok to move, and arc voltage signals between the plasma cutter and the control console. (Customer is responsible for installing the automation torch to the plasma table.)

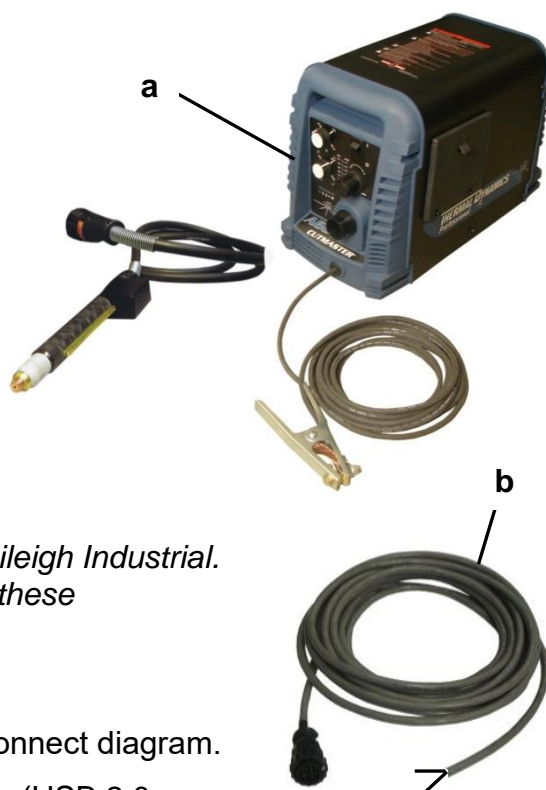

**IMPORTANT:** Items a and b are included with the plasma cutter. These items are not included if you do not purchase a plasma cutter from Baileigh Industrial. You will need to contact your plasma cutter provider for these components and connection information.

### **Also included:**

- Baileigh Industrial operator's manual with wire interconnect diagram.
- Flash drive with assorted files and copies of manuals. (USB 2.0 compatible)
- Operating manual for torch power unit (when ordered).
- Controller operating manual.

### **Items Not Included with the Table**

- Electrical plugs or connector for input power to the console and plasma cutter.
- Clean, dry air/gas supply to the plasma cutter.
- Computer to operate CAD-CAM software.
- Other tools and equipment used to safely move and handle materials.



## Torch Mounting

1. Power the console on and fully lower the Z axis.
2. Power the console off.
3. If installed, remove the gear rack from the torch body by taking out the socket screw, pivoting the rack, and carefully pulling it out from the torch mounting tube.
4. Loosen the clamping screws (A). Slide the torch through the center bushing.
5. Extend the torch through the bushing so that the torch tip just touches the top of the material supports.
6. Hold the torch in this position and tighten the clamping screw just enough so that the torch does not slip within the bushing.
7. Power the console on and fully raise the torch.
8. Place a flat piece of material on the table cutting surface under the torch and lower the torch until it just touches the material.
9. For final adjustment, use a square to align the torch perpendicular to the surface of the work piece. Check for both front to back and side to side position.
10. Use the adjusting screws to align the torch. When the torch is perpendicular to the table, fully tighten the clamping screws (A)

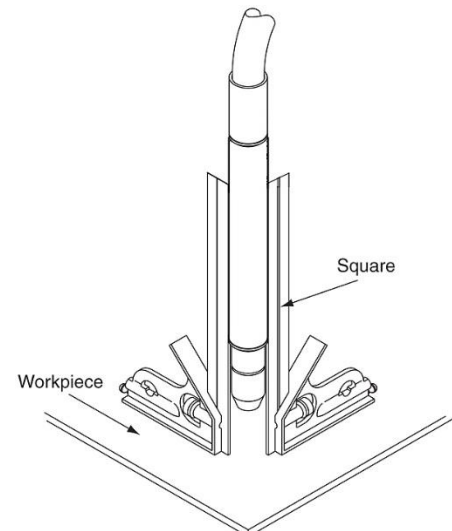
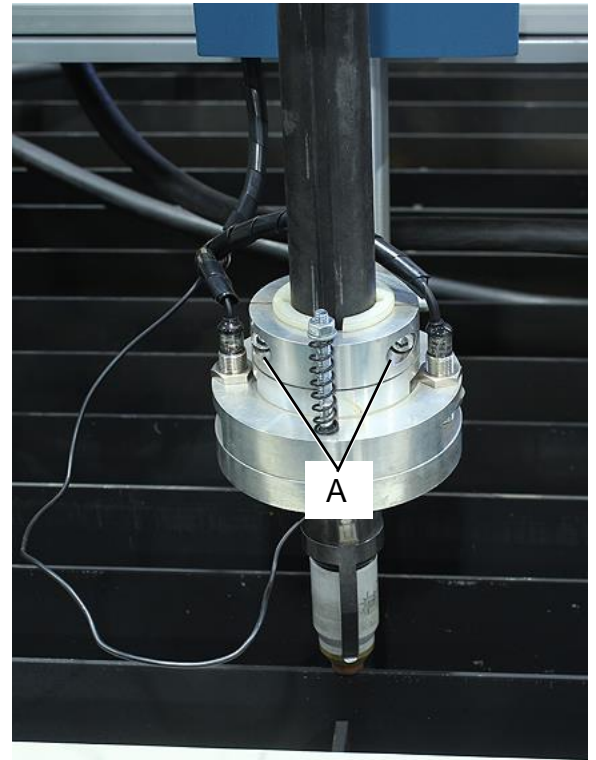



## Torch Cable Routing

The plasma torch cable is typically routed through the cable tracks and cable trays back to the plasma cutter power unit.

It is generally common to start at the torch holder and work back to the plasma cutter.



1. Remove the cover (A) from the X axis steel cable tray.
2. Insert the end of a small flat bladed screwdriver into each opening (B) of the cross member on the inside of the cable track loop. The cross members are hinged and will then pivot to open and allow for the cable to be placed into the track.
3. Open all of the cross members.

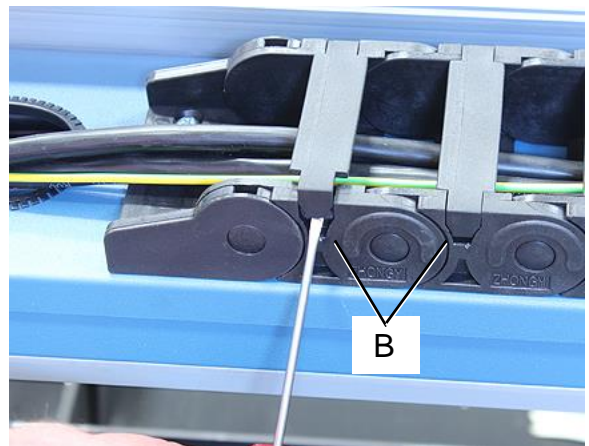



4. Allow for a loop (C) from the torch to the entry point (D) of the cable track. This will help to eliminate unnecessary stress on the cable.
5. At the entry end of the cable track, remove the two screws securing the cable track mounting link to the support bracket.
6. Carefully unlock the mounting link (E) from the main cable track chain. This will allow for the room needed to fit the torch cable connector through the cable track.
7. Route the torch cable through the cable track and out of the end of the X axis cable track and into the steel cable tray (A).

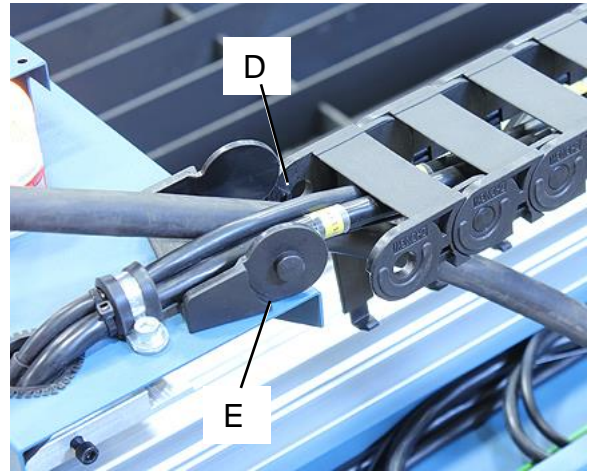

8. When the torch cable is routed through the X axis cable track, carefully connect the mounting link to the main cable track chain and secure the mounting link to the support bracket.
9. Support all of the wires and cables inside of the cable track and latch each of the cross members to secure the cables and wires inside of the cable track.



**NOTE:** It is recommended to position the torch cable toward the side of the cable track closer to the gantry. It is also recommended to position all of the cables and wires to lay flat and not cross or twist with each other.

10. Open the right-side motor cover by removing all but the lower two screws (F). This will allow the cover to hinge open.



**NOTE:** Be careful not to damage the limit switch wires when opening the cover.

11. At the entry end of the cable track, remove the two screws securing the cable track mounting link (G) to the support bracket.
12. Carefully unlock the mounting link (G) from the main cable track chain. This will allow for the room needed to fit the torch cable connector through the cable track.
13. Form a gentle curve and route the cable into the Y axis cable track.

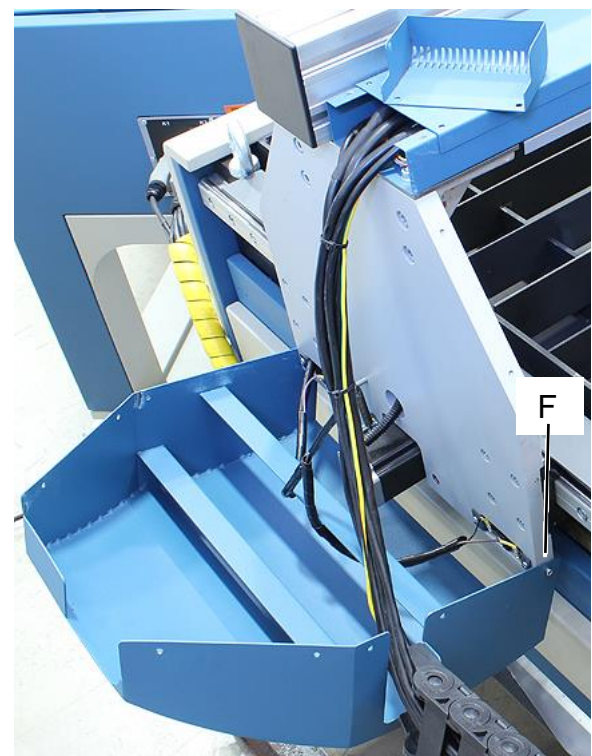



14. Route the torch cable through the Y axis cable track positioning the cable towards the outboard side of the track.

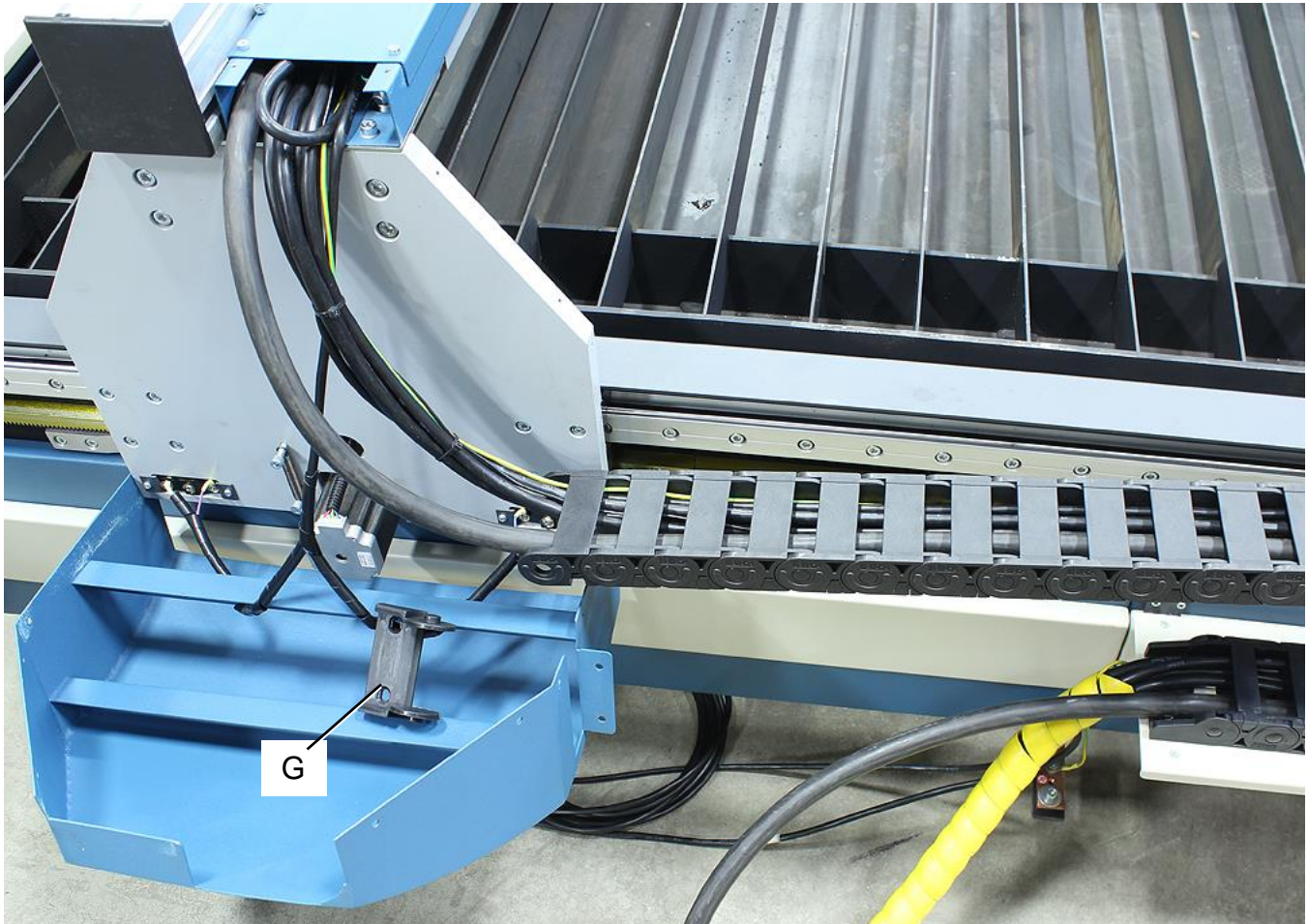

15. When the torch cable is routed through the Y axis cable track, carefully connect the mounting link to the main cable track chain and secure the mounting link to the support bracket.

16. Allow the torch cable to exit the Y axis cable track and route the cable to the plasma power unit.

17. Support all of the wires and cables inside of the cable track and latch each of the cross members to secure the cables and wires inside of the cable track.

18. Close the right-side motor cover. Verify that no wires have been pinched or disconnected.



**IMPORTANT:** Be careful not to kink or flatten the torch cable during installation.



### Water Fill

Add water to the table tank until the water level at the top of the material supports.

Drain, clean and refill will be based upon usage. Heavy usage will fill the table with debris while light usage will allow bacteria to grow.

Add a general anti-bacterial as needed.

If the table will be unused for 2 or more weeks at a time, it is recommended to drain the tank until the next usage.

Fill Level  
Top of Grate  
to 1/4" below top

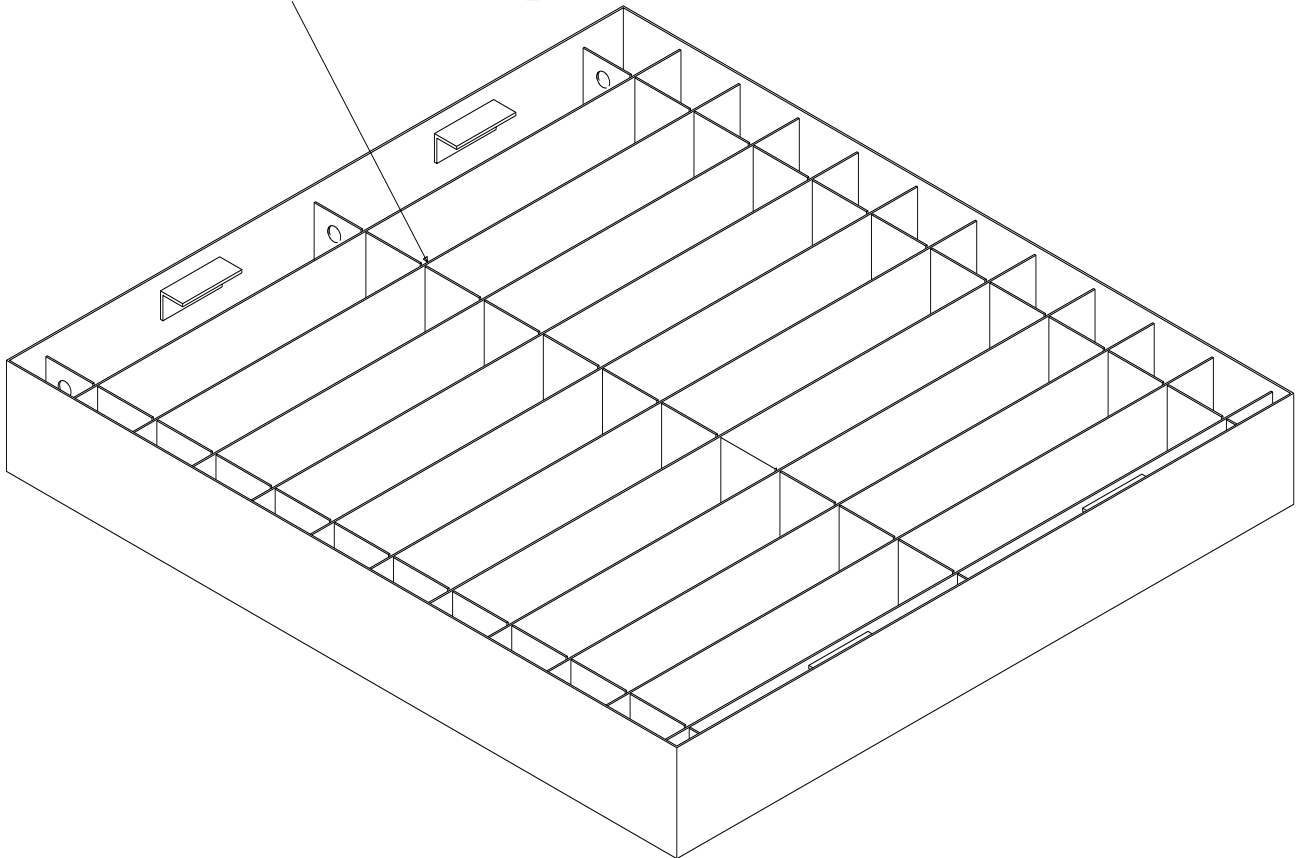



## ELECTRICAL

 **CAUTION:** HAVE ELECTRICAL UTILITIES CONNECTED TO MACHINE BY A CERTIFIED ELECTRICIAN!  
Check if the available power supply is the same as listed on the machine nameplate.

 **WARNING:** Make sure the grounding wire (green) is properly connected to avoid electric shock. DO NOT switch the position of the green grounding wire if any electrical plug wires are switched during hookup.

### Power Specifications

Your machine is wired for 220 volts, 60hz alternating current. Before connecting the machine to the power source, make sure the power source is OFF.

Before switching on the power, you must check the voltage and frequency of the power to see if they meet with the requirement, the allowed range for the voltage is  $\pm 5\%$ , and for the frequency is  $\pm 1\%$ .

### Considerations

- Observe local electrical codes when connecting the machine.
- The circuit should be protected with a time delay fuse or circuit breaker with an amperage rating slightly higher than the full load current of machine.
- A separate electrical circuit should be used for your machines. Before connecting the motor to the power line, make sure the switch is in the "OFF" position and be sure that the electric current is of the same characteristics as indicated on the machine.
- All line connections should make good contact. Running on low voltage will damage the motor.
- In the event of a malfunction or breakdown, grounding provides a path of least resistance for electric current to reduce the risk of electric shock. This machine is equipped with an electric cord having an equipment-grounding conductor and a grounding plug. The plug must be plugged into a matching outlet that is properly installed and grounded in accordance with all local codes and ordinances.

 **WARNING:** In all cases, make certain the receptacle in question is properly grounded. If you are not sure, have a qualified electrician check the receptacle.



- Improper connection of the equipment-grounding conductor can result in risk of electric shock. The conductor with insulation having an outer surface that is green with or without yellow stripes is the equipment-grounding conductor. If repair or replacement of the electric cord or plug is necessary, do not connect the equipment-grounding conductor to a live terminal.
- Check with a qualified electrician or service personnel if the grounding instructions are not completely understood, or if in doubt as to whether the machine is properly grounded.
- Repair or replace damaged or worn cord immediately.

### Cord and Power Connection

1. Verify that the power is OFF to the console.
2. Turn the On/Off rocker switch and the E-Stop on the control panel to the OFF position.
3. Route the flexible conduit from the table to the control console and connect the connectors (A and B) to the console and lock them into the receptacles.
4. The ground wire from the table must also be connected to the console frame (D).
5. Unwrap the power cord (C) and route the cord away from the machine toward the power supply.
  - a. Route the power cord so that it will NOT become entangled in the machine in any way.
  - b. Route the cord to the power supply in a way that does NOT create a trip hazard.

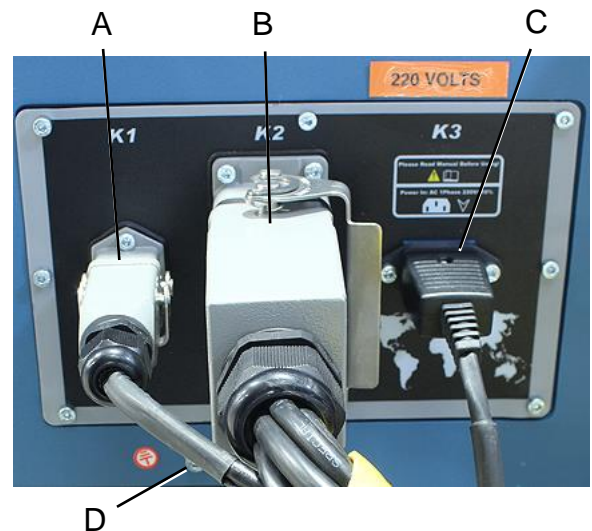

**Note:** If the power cord has a molded 110V style plug on the opposite end, cut off and discard the plug before making the power connections.

6. Connect the power cord to the power supply and check that the power cord has not been damaged during installation.
  - a. Connect the yellow wire (**PE**) to ground.
  - b. Connect the Brown wire (**L**) to line voltage.
  - c. Connect the Blue wire (**N**) to line voltage.
7. When the machine is clear of any obstruction. The main power switch may be turn ON to test the operation. Turn the switch OFF when the machine is not in operation.





## PLASMA CUTTER WIRE CONNECTIONS

**NOTICE:** This system uses 50:1 divided voltage. YOU MUST VERIFY THIS WITH THE PLASMA CUTTER MANUFACTURER. Damage from using the incorrect divided voltage is not covered by warranty.

This table requires 6 wire connections to the plasma cutter. These connections will be made by the customer and must match exactly between the wires within the harness from the table to the plasma cutter.



**IMPORTANT:** IT IS THE RESPONSIBILITY OF THE CUSTOMER TO VERIFY THAT THESE CONNECTIONS ARE CORRECT FOR THE PLASMA CUTTER BEING USED!

Listed below are connections to 3 common plasma cutter manufactures. Please verify with the manual supplied with the cutter to be certain that the wiring has not changed.



Wire Label	Function	Connects to Cutter
19 And 20	These two wires are used for the plasma arc Start / Stop signal. This is a normally open circuit. When a relay within the console is energized and closes, the plasma cutter/torch will fire and continue until the relay is de-energized. These are NOT polarity sensitive.	Start / Stop
0V And 06	OK to Move. This is a feedback from the plasma cutter to the controller to tell the system that it is OK to start running the program. These are NOT polarity sensitive.	OK to Move
Arc - Arc +	<p>THESE ARE POLARITY SENSITIVE. This is the divided arc signal.</p>  <p><b>IMPORTANT:</b> This system uses 50:1 divided voltage. <u>You must verify this with the plasma cutter manufacturer.</u> Damage from using the incorrect divided voltage is not covered by warranty.</p>	5 (-, Neg.) And 6 (+, Pos.)



### Thermal Dynamics



**IMPORTANT:** THIS IS FOR REFERENCE ONLY. This instruction is based upon generally available information. Contact the manufacturer of your plasma cutter for specific set up information.

Signal	Sockets / Wire No.	Wire Colors
Start / Stop (plasma arc)	3, 4	Red, Black
OK to Move (start machine motion)	12, 14	White, Green
Voltage Divider	5 (-), 6 (+)	Yellow (-), Blue (+)

### HyperTherm



**IMPORTANT:** THIS IS FOR REFERENCE ONLY. This instruction is based upon generally available information. Contact the manufacturer of your plasma cutter for specific set up information.

Signal	Sockets / Wire No.	Wire Colors
Start / Stop (plasma arc)	3, 4	Green, black
OK to Move (start machine motion)	12, 14	Red, black
Voltage Divider	5 (-), 6 (+)	Black (-), white (+)

### Miller



**IMPORTANT:** THIS IS FOR REFERENCE ONLY. This instruction is based upon generally available information. Contact the manufacturer of your plasma cutter for specific set up information.

Signal	Wire Colors
Start (start plasma)	Blue, Blue/White
Transfer (start machine motion)	Orange, Orange/White
Voltage Divider	Brown (+), Brown/White (-)

### SOFTWARE

A license of BobCad/Cam Express is supplied with each table. BobCad will provide the training and instructions for the operation of the software.



**IMPORTANT:** Download and use the “**Baileigh Plasma FangLing Post**” post set from the BobCad/Cam website for use with this controller.

[http://partners.bobcad.com/?source=P\\_474463](http://partners.bobcad.com/?source=P_474463)



## Ohmic Clip Connection



**IMPORTANT:** THE OHMIC CLIP CONNECTION WILL NOT FUNCTION WITH ALL MAKES AND MODELS OF PLASMA CUTTERS!

The Ohmic clip circuit allows the torch to sense the material electrically during the touch off function. This provides a more precise torch height position for the pierce and start of the cut. Without the Ohmic clip the torch still senses the material using a physical contact from the torch breakaway circuit.

Plasma cutter manufacturers use their own electrical circuitry for the cutting operation. Because of this variation from the plasma cutter manufacturers, some circuitry does not work well for Ohmic touch off.

1. At initial set up, follow the diagram in the plasma cutter manual for the exact and specific consumables to be used to cut the type and thickness of material desired at the chosen amperage setting.
2. Connect the Ohmic Clip sensing wire to the clip or connector provided by the plasma cutter manufacturer.

## Thermal Dynamics



**IMPORTANT:** THIS IS FOR REFERENCE ONLY. This diagram is based upon generally available information. Contact the manufacturer of your plasma cutter for specific set up information.

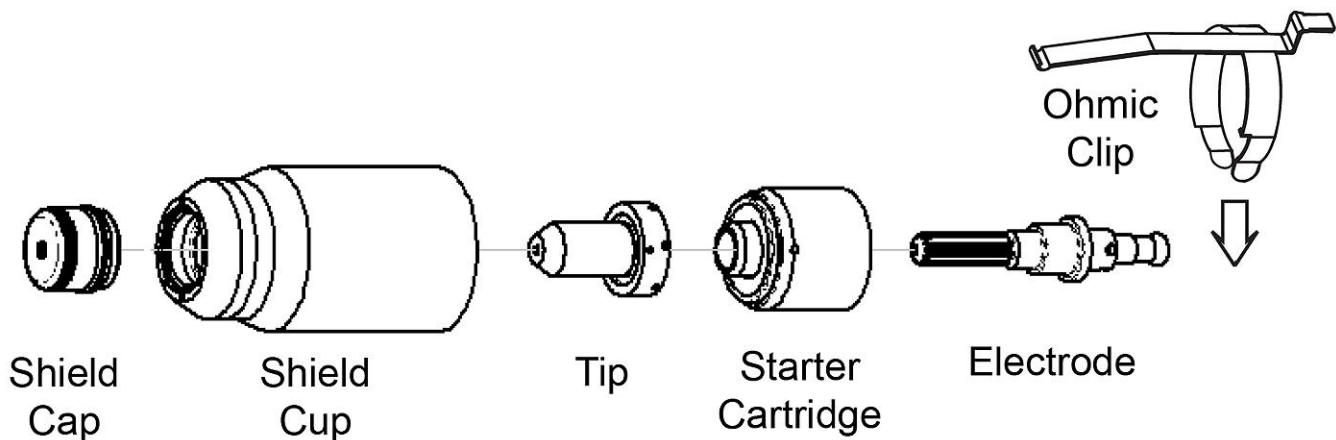

## HyperTherm



**IMPORTANT:** THIS IS FOR REFERENCE ONLY. This diagram is based upon generally available information. Contact the manufacturer of your plasma cutter for specific set up information.

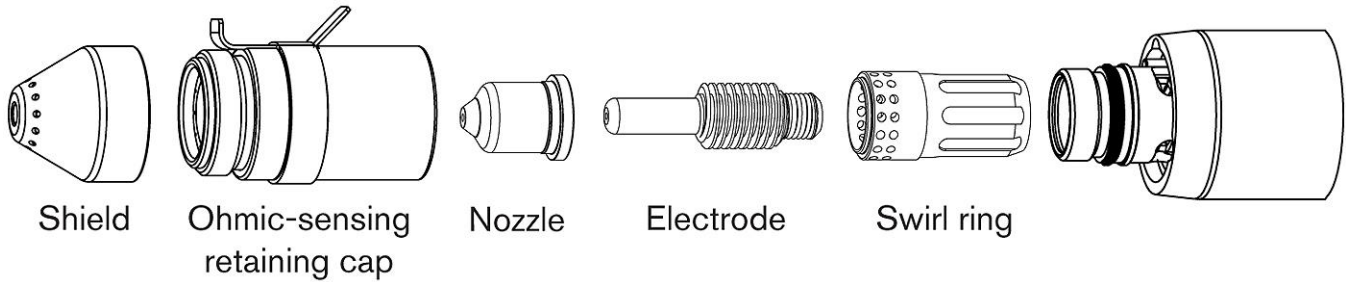

**Miller**



**IMPORTANT:** THIS IS FOR REFERENCE ONLY. This diagram is based upon generally available information. Contact the manufacturer of your plasma cutter for specific set up information.

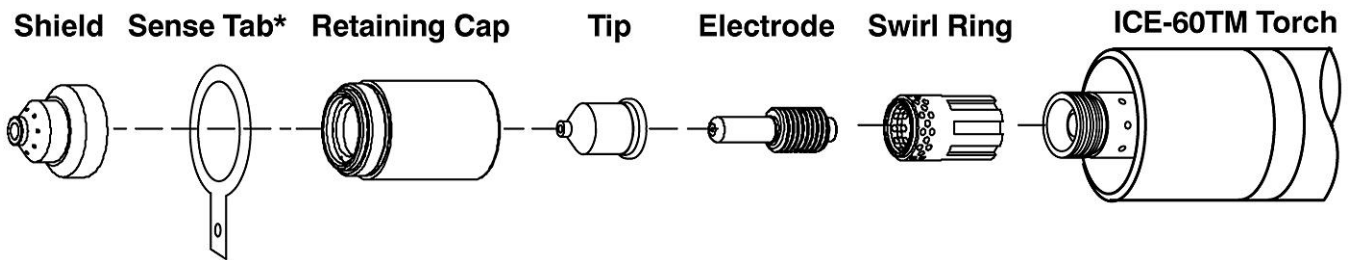

3. Prepare the table for a test cut.
4. Observe the IHS Signal indicator. The indicator dot for the IHS Signal should be Red until the torch tip touches the material and turns to Green during touch test. This is a momentary function that will only last about 0.5 seconds.
5. If the Dot is Green as soon as the Ohmic wire is connected to the torch sense terminal;
  - a. First verify that the consumables are correct. Mis-matched consumables will produce a faults signal.
  - b. When the consumables have been verified, disconnect the ohmic sensing wire from the torch terminal and be sure that it does not touch anything else.
  - c. Does the dot turn to Red? If yes, then do not use the Ohmic sensing wire.
6. Tape the wire back out of the way of the torch and the lifter so that the terminal end will not contact any metal surface of the machine. It is NOT recommended to cut the wire off as it may be able to be used if the plasma cutter is ever changed.

Status:	Current Line/Hole:
Stop	00000 / 00000
SetArc:	146.0 Actual Arc: 000.0
● IHS Check	S
● ArcTime	S
● Pierce	S
● TorchUp	S
● TorchDn	S
● LockTHC	S
● Arc Feedback	S
● IHS Signal	S
[2/3] Pierce Time	0.50 [0] Manual THC
[5/6] IHS Up Time	0.30



## PLASMA TABLE START-UP PROCEDURE

- Verify that all cables are connected to the console.
- **MAKE SURE** all equipment is properly grounded. Consult a qualified electrician.
- Verify that all components have the correct utilities connected both electrical and air. (Consult individual operator's manuals)
- Check that the torch has the correct consumables for the amperage you will be running at. Replace any torch consumable's that appear damaged or distorted.
- Be sure and connect the ground clamp from the torch power unit directly to the material being cut.
- Turn on the torch power unit. Set air pressure on the torch power unit per specifications in the plasma cutter operator's manual.

### Power up the control console:

1. Complete the connection of the console to the plasma table including connecting the console to a 220V single phase power supply.
2. Twist the emergency stop button clockwise (**cw**) to reset.
3. Turn the rock switch to the **ON** position.

### Checking motion of the servo motors:

1. From the Logo screen, press the ENTER key to enter the operating screen.
2. Use the Arrow keys to move the torch on the X and Y axis of the table.
3. Use the "S↑/PgUp" and "S↓/PgDn" buttons to test the motion of the torch in the "Z" axis.



**IMPORTANT:** See Book 2 of 2 for detailed controller operation.





## **GENERAL PLASMA TABLE INFORMATION**

Whether cutting an artful design to be hung on a wall as a decoration or a simple plate to be welded to an I-beam to hold up the wall, plasma cutting like most metal working has an artistic component to completing a successful cut. This is a consideration often overlooked when incorporating automated equipment into the creation of metal parts and pieces.

Cutting with a plasma system takes time and experience to develop the skill and knowledge to become an accomplished cutter. Experienced operators often seem to take for granted the knowledge they have gained from operating a plasma system and learning and taking notes. New operators often seem to overlook the knowledge needed to cut properly. This is especially evident when automation is added to the system. There can be an expectation that the parts will be cut perfectly with machined quality edges. The automation simply controls the movement of the torch, it cannot and does not improve upon the quality at which a plasma system can cut. It does provide consistency, repeatability, and accuracy.

The best recommendation is to practice, take notes, experiment, and seek out advice through technical colleges, individual mentoring with an experienced operator, and through online forums and trade magazines.

### **The Plasma Systems**

The plasma system can be broken down into 4 broad areas which are at the same time separate and interacting.

### **Software / Program Code Creation**

The software provided with the system is a relatively simple to use CAD based drawing and coding program. Using the software you can create a new drawing or import files such as \*.DXF, \*.BMP, \*.JPG, \*.JPEG, \*.GIF, \*.TIF, \*.PNG, \*.AI, \*.EPS, \*.PLT, & \*.TXT files. Once created, the file can be processed to create the code needed to run the shape on the table.

It is recommended that the software operator consider taking drawing classes at a local Technical College to gain additional knowledge and experience. They will not likely have the exact software as is supplied with the table, however, most of the techniques and functions will be very similar or the same.

Along with the training, several other tips include:

- Find and use the F1 key to open the help menu. This will provide specific instructions and descriptions of all of the software capabilities.
- Start simple. Draw a few simple shapes. Plan the sizes so that they will fit on extra material that may be available to practice cutting on. Once comfortable with drawing and getting a basic cut, move on to some simpler production pieces.
- Practice using both the menu and right clicking as you work with the object being drawn. As with most software, there are many ways to complete a specific task or action. This will help to find those different options.



**Table Operation**

Once an object has been drawn and coded into G code format, it may be taken to the table to have the table run the pattern.

This is what the table does. It is all the table does. Run a pattern of the specific object that has been loaded to run.

The table does provide other control setting which will complete the operation; however, this is all based upon the information which has been included in the G code.

The basic function which are adjustable on the table are:

- Pierce Delay. This is the time it takes for the plasma arc to punch a hole through the material to be cut. The torch does not move during this operation. Ideally, the torch will start to move and run the pattern at the exact moment it has pierced the material.
- Pierce and Cut Height. This is the distance between the material surface and the bottom (closest surface) of the torch. While it is necessary to have the proper height. First time cutters commonly error toward having too large a cut height. This will generally improve as the operator learns how the table and the material react during cutting.
- Cutting Speed. This is how fast the table moves the torch around during the cutting process. This can vary widely. Consult your plasma cutter manual for suggested cutting speeds for the material and amperage you are cutting at. The tables included with the cutter manual provide good starting points for all the settings needed to cut a given material. As the operator becomes more familiar with the cutting process for a given material, these setting may be adjusted to provide for the best cut possible.
- Other setting and adjustments available at the table are explained in greater detail in the controller manual.

**Cutter Set-up and Operation**

The cutter set-up is ultimately the key to the best cut possible. While items like Kerf are set in the software, and speeds or height are set at the table, the cutter must also be set to match material and amperage to be used during the cut.

For example: Let's compare 3mm (11ga is closest) Mild Steel to be cut at either 40 or 60 amps. Each amperage setting has different cutting requirements.

First are the consumables. Each amperage setting uses different consumables. These must be taken from and match the requirements as listed in the manual for your plasma cutter based upon the specific material and amperage you will be cutting at. If you mix consumables, you will either get poor cut results and/or the cutter will perform erratically. Not starting an arc or holding and arc.

Material Thickness	Gas Pressure (Air)	Arc Voltage	Torch Working Height	Travel Speed	Initial Piercing Height	Pierce Delay	Kerf Width @ Rec. Speed
<b>Mild Steel @ 40A</b>							
(mm)	Bar	Volts	(mm)	(mm/min)	(mm)	(sec)	(mm)



3	5.5 (15.2)	112	4.1	1794	4.1	0.1	1.7
<b>Mild Steel @ 60A</b>							
(mm)	Bar	Volts	(mm)	(mm/min)	(mm)	(sec)	(mm)
3	6.2 (15.2)	126	4.8	5080	5.1	0.1	2.2

As is visible, the Pierce Delay is the same between the two amp settings. All other settings are different. The largest variation is the cutting speed. A setting like Kerf is best planned for and set in the software. Air pressure is set at the cutter. Speeds are set on the table controller. Volts, Heights, and Delays are set at the Auto-Height Control.

### **Adjusting to the Variable**

Some other variable which affect the cutting performance include but are not limited to:

- **Material Quality.** New, clean material from a consistent supplier will normally provide the best results. Changing suppliers or using reclaimed materials will often require some adjustments to the settings normally used for a similar material. This is normal and typically not a problem when it has been acknowledged, planned for, and adjusted to. Other material factors are the cleanliness of the material. Oils, rust inhibitors, and rust or scale will also affect the cut results. Cleaning the surface will produce better more consistent results.
- **Air / Gas Quality.** Dry. The dryer the better. It is recommended to use a good and regular maintenance schedule to remove moisture from your air supply. It is also recommended to use a high quality air drying system as well. While an air filter is needed, it is not for removing moisture from the air. Using a drying system along with good maintenance will provide a more consistent and predictable cut. This will also provide much longer life for the consumables.
- **Environmental conditions.** Seasonal changes, altitude above sea level, proximity to large bodies of water (oceans or great lakes) will also play a factor in the final cut results. While relatively minor, it is a worth noting when experiencing some adjustments between January to August, or if consulting a forum between Florida and Nebraska.

### **Expectations**

Plasma cutting is not Lazar cutting. It is not Flame cutting. It is not a sheared or machined edge. While specific definitions will be more accurate and include more of the science and technology behind plasma, Plasma cutting for this purpose is the controlled melting of metal.

The table does not do the cutting. The table moves in a controlled manner to be predictable, repeatable and accurate.

The software is engineering or modeling software. It can open up a great deal of practical and creative project for the operator willing to learn to use it.





## BASIC / QUICK CONTROLLER OPERATION

### General Commands



**Note:** This is a quick overview. Refer to book two for a more detailed explanation of the controller operation and other more detailed functions.

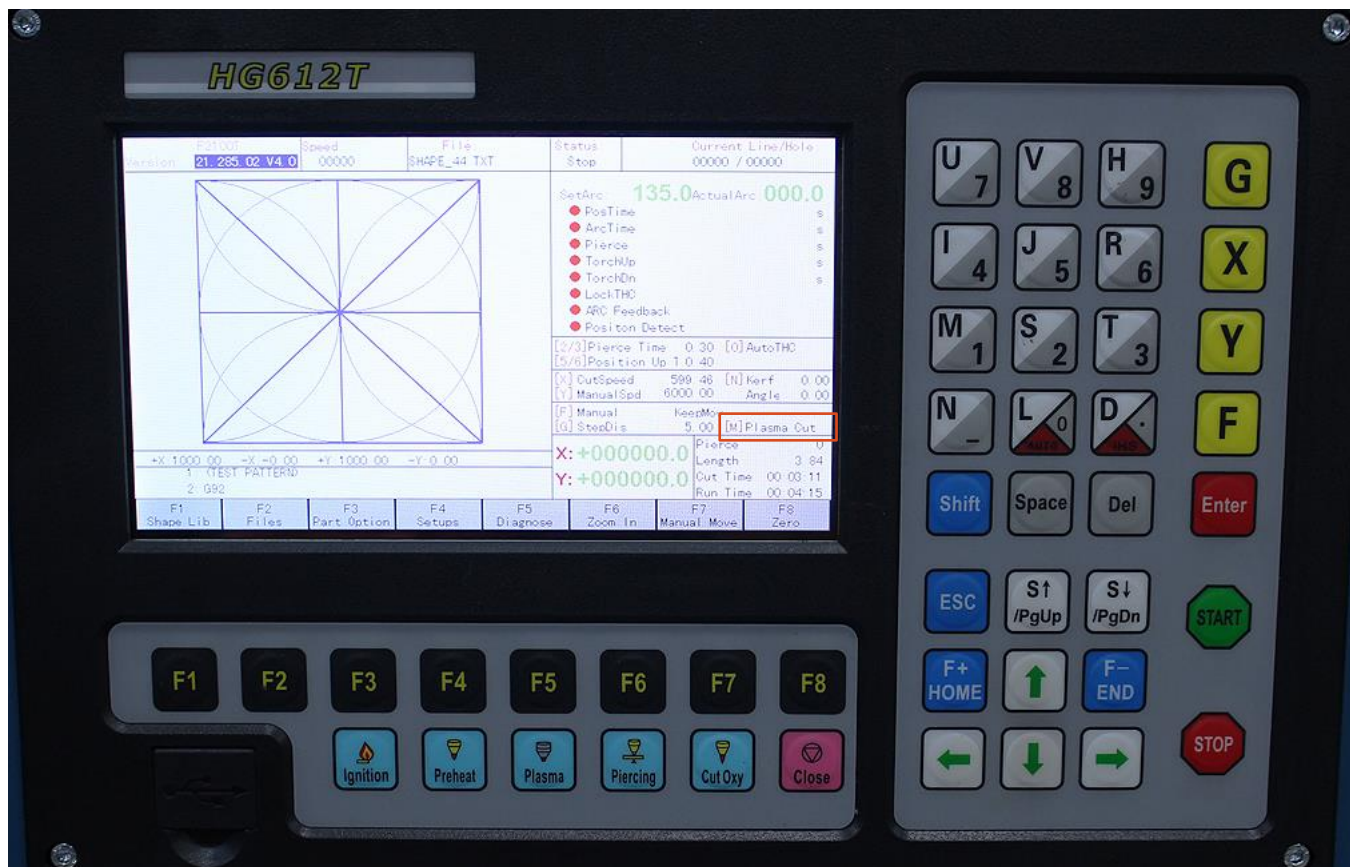

- The basic HOME screen will be similar to what appears above. The [M] line will be "Plasma Cut"; the last item cut will be in the display, and the last settings for that cut will be displayed.
- The system will remember and operate based upon the last saved parameters.
- When navigating around the screens, the "ESC" key will move back one screen at a time. The "ESC" key will also cancel any entry made to a parameter setting.
- The RED dots are normal and indicate that the function is not being used at this time. The dot will turn Green when a function is active.
- The numbers and letters inside of the "[brackets]" may be pressed for direct access to that parameter. Example: Pressing the letter "X" from this screen will open a dialog box that will allow direct entry of a new cutting speed.



- The function (“F keys”) are used to operate the system. Access files, change operator setting, and tune operation.
- Pressing the “SPACE” key will change the function (“F keys”) to display more cutting options.
- When making changes to parameters, be sure to save the change. This is typically the “F8” key. “ESC” will cancel the change.
- The “Arrow” keys move the gantry around the table. The “Arrow” keys are also used to navigate around the parameter setting fields.
- The “S↑” and the “S↓” key are used to raise and lower the torch.

### General Operation Steps



**Note:** Always observe the screen messages, settings, and Function key labels.

- Power On. When the Logo screen appears, press the Enter key.
- Choose location for the program to be run from. Shape Library [F1], or File [F2]. File may be already stored on the controller or from a USB Disk.
- From the Shapes Library, use the arrow keys to navigate to the desired shape and press the F8 Ok key. Change the dimensions as desired and press F8 to save the settings.

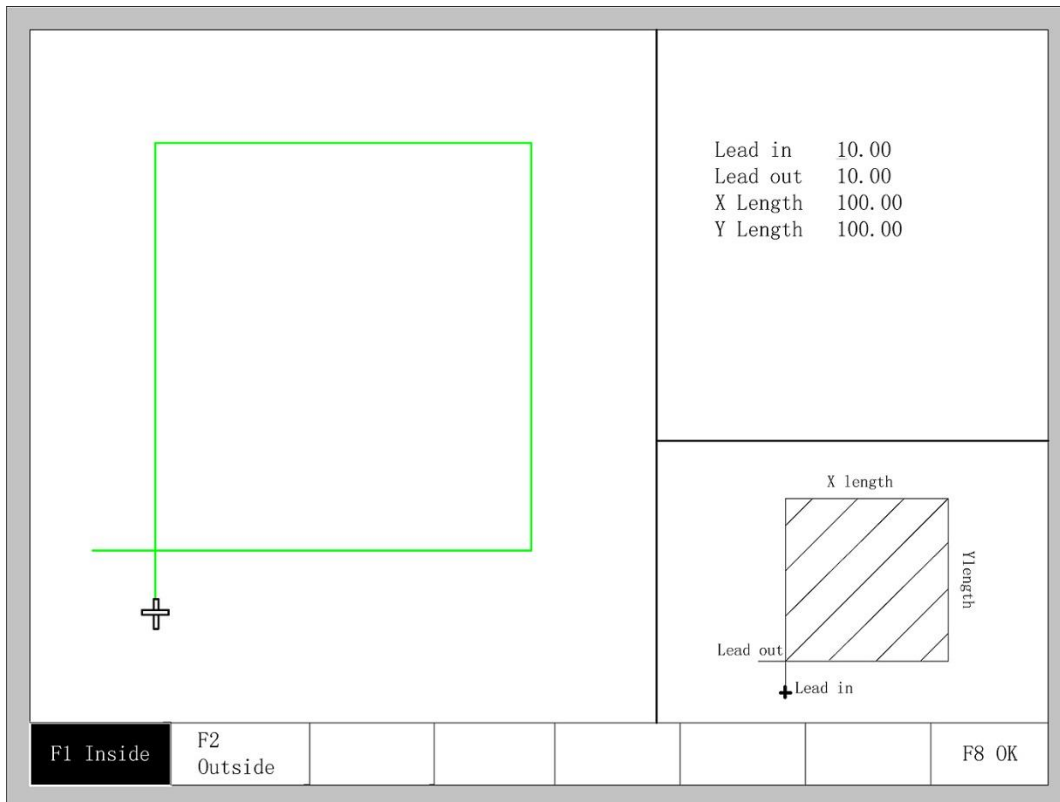



- From the “Home” screen, press F4 to enter the settings pages. In the settings pages, F1 “Common” and F3 “Plasma” are typical screens for operational changes. The other screens are not used or do not normally have settings that should be changed.

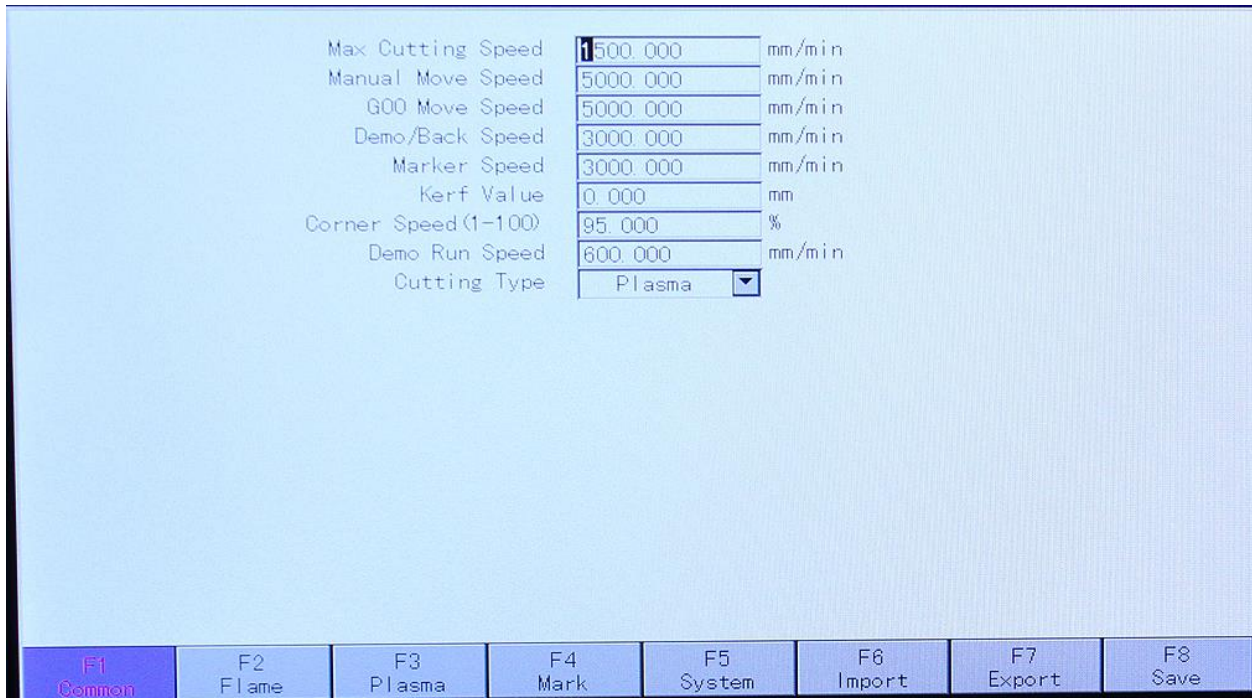

- On the F1 Common screen, the “Max Cutting Speed” and possibly the “Kerf Value” are the only two settings that are likely to change. These line generally only change with the change to the thickness of the material being cut. These values can be edited directly from the Main Screen by pressing the X or N keys and then entering the desired value.



- The F3 Plasma screen settings are also available from the main screen. The main difference between the Main screen access to the F3 setting and the F1 is that the F3 settings are changed in steps while the F1 settings open a dialog box which allows for entry of a specific value.
- These settings will start with the information provided by the plasma cutter manufacturer, and then be fine-tuned based upon the specific cutting conditions. Keep notes of changes for future use.
- In the F3 screen, these values can be changed to exact values to “Fine Tune” the cutting process.

DelayBeforeArc	0.20	s	Pierce Count	5	Clear
Pierce Time	0.20	s	WorkPiece Count	1	Clear
Torch Up Time	0.26	s	Cut Length (m)	1.48	Clear
Arcing Check Time	10.00	s	Cut Time	00:00:43	Clear
Position Check Time	7.00	s	Run Time	00:01:15	Clear
Position Up Time	0.50	s			
Speed to Lock THC	95.00	mm/min%			
Distance to Lock THC	5.00	mm			
Time of Disable THC After Piercing	0.00	s			
Lose Arc Delay	0.00	s			
Time to Lock THC before M08	0.00	s			
Watch Arc Enable	<input checked="" type="checkbox"/>				
Use Cylinder THC	<input type="checkbox"/>				
Set Arc Voltage	130.00	V			
Arc Protection Value	30.00	V			
THC Sensitivity	40.00	%			
Arc Set Step Value	1.00	V			
FastIHSTime	6.00	s			
Flame Updown Speed	100.00	%			
Plasma Updown Speed	100.00	%			

F1 Common	F2 Flame	F3 Plasma	F4 Mark	F5 System	F6 Import	F7 Export	F8 Save
--------------	-------------	--------------	------------	--------------	--------------	--------------	------------

- The values commonly changed on the F3 screen are the Pierce Time, Torch Up Time, Position Up Time, and Set Arc Voltage.
- It is uncommon to change any of the other settings on this screen.
- Be sure to save [F8] any changes.



- After Save, press “ESC” to return to the “Home” screen.

Version	F2100T 21.285.02 V4.0	Speed:	00000	File:	SHAPE_11.TXT	Status:	Stop	Current Line/Hole:	00000 / 00000
						SetArc: 130.0 ActualArc: 000.0 <input type="checkbox"/> PosTime s <input type="checkbox"/> ArcTime s <input type="checkbox"/> Pierce s <input type="checkbox"/> TorchUp s <input type="checkbox"/> TorchDn s <input type="checkbox"/> LockTHC <input type="checkbox"/> ARC Feedback <input type="checkbox"/> Position Detect			
						[2/3]Pierce Time 0.20 [0]AutoTHC [5/8]Position Up T 0.50 [X] CutSpeed 1500.00 [N] Kerf 0.00 [Y] ManualSpd 5000.00 Angle 0.00 [F] Manual KeepMov [G] StepDis 5.00 [M] Plasma Cut			
+X:24.15 -X:-24.15 +Y:27.50 -Y:-27.50 1: ( Circle Slice - Piece ) 2: G92						X: +000000.0 Pierce 5 Y: +000000.0 Length 1.48 Cut Time 00:00:43 Run Time 00:01:15			
F1	F2	F3	F4	F5	F6	F7	F8		
Shape Lib	Files	Part Option	Setups	Diagnose	Zoom In	Manual Move	Zero		

- Pressing the F3 key will open the Part Options functions. These can be used to change and alter the file which is loaded. F7 Revert will cancel ALL changes applied to the file. PRACTICE THESE CHANGES UNTIL YOU ARE COMFORTABLE WITH THE OUTCOME.
- F8 will save the changes.

Version	F2100T 21.285.02 V4.0	Speed:	00000	File:	SHAPE_11.TXT	Status:	Stop	Current Line/Hole:	00000 / 00000
						<input type="checkbox"/> X Mirror <input type="checkbox"/> Y Mirror <input type="checkbox"/> CutSpeed 1500.00 [N] Kerf 0.00 <input type="checkbox"/> ManualSpd 5000.00 Angle 0.00 <input type="checkbox"/> Manual KeepMov <input type="checkbox"/> StepDis 5.00 [M] Plasma Cut			
						+X:24.15 -X:-24.15 +Y:27.50 -Y:-27.50 Operate Mode: PartOption			
X: +000000.0 Pierce 5 Y: +000000.0 Length 1.48 Cut Time 00:00:43 Run Time 00:01:15									
F1	F2	F3	F4	F5	F6	F7	F8		
Start Point	Angle	Array	Scale	SellLine Pierce	Edit File	Revert	OK		



- Pressing the “Space” key will change the function keys to other choices.



**IMPORTANT:** The Demo and Frame functions WILL cause the table/gantry to move. Verify that the head and torch will not contact material or tools and that all persons around the machine are clear and away from the table.

Version	F2100T 21.285.02 V4.0	Speed:	00000	File:	SHAPE_11.TXT	Status:	Stop	Current Line/Hole:	00000 / 00000
						SetArc:	130.0	ActualArc:	000.0
						• PosTime		s	
						• ArcTime		s	
						• Pierce		s	
						• TorchUp		s	
						• TorchDn		s	
						• LockTHC			
						• ARC Feedback			
						• Position Detect			
						[2/3] Pierce Time	0.20	[0] AutoTHC	
						[5/8] Position Up	1.0	50	
						[X] CutSpeed	1500.00	[N] Kerf	0.00
						[Y] ManualSpd	5000.00	Angle	0.00
						[F] Manual	KeepMov		
						[G] StepDis	5.00	[M] Plasma Cut	
						X: +000000.0	Pierce	5	
						Y: +000000.0	Length	1.48	
							Cut Time	00:00:43	
							Run Time	00:01:15	
F1	F2	F3	F4	F5	F6	F7	F8		
Back	Demo	Frame	SpeedDown	SpeedUp	Arc Reduce	Arc Add	Jump to Pierce		

- Start with F3 “Frame”. This function is direct acting. The gantry WILL start to move when the F3 key is pressed. F3 will frame the area that the part will be cut from. This is a general box that the part will fit in.
- Next is F2 “Demo”. This function is direct acting. The gantry WILL start to move when the F2 key is pressed. F2 will run the program as a test. The head will move to all of the cut positions and paths, however, it will not send a signal to start the plasma torch. No cutting will happen.
- The other function keys on this screen will make changes to the operating parameters as labeled.
- Once the settings have been completed, place test material on the table.
- Load a file to test cut.
- Use the “Arrow” keys to move the torch to desired origin / start point. Press F8 ZERO. The work piece origin is now zeroed.
- Verify that the plasma cutter has the correct consumables installed for the material and amperage; the air supply is correct, and that the cutter is on.



- Press “Start” to start the program.
- Press “Stop” to pause or stop the program. (Start will resume)
- During the cut.
  - Press F4 to slow down or press F5 to speed up the cutting travel speed.
  - Press F6 to decrease value of the arc voltage or press F7 to increase value of the arc voltage.

### Plasma Cutting Mode Type

This controller may be operated using either the Manual THC (Torch Height Control) or Auto THC (Torch Height Control).

Pressing the number “0” key will change between these two options. Press the number “0” to change back again.

This setting may be changed while a program is cutting if needed.

### Thermal Dynamics



**IMPORTANT:** This instruction is based upon generally available information at the time of testing. Baileigh Industrial Holdings LLC. Cannot be held accountable for changes made to the plasma cutter which may change these results. Contact the manufacturer of your plasma cutter for specific set up information.

When using Thermal Dynamics before approximately 9-2018, the system should work in either Manual or Auto THC.

If the cutter is after 9-2018, use Manual THC only.

### HyperTherm or Miller



**IMPORTANT:** This instruction is based upon generally available information at the time of testing. Baileigh Industrial Holdings LLC. Cannot be held accountable for changes made to the plasma cutter which may change these results. Contact the manufacturer of your plasma cutter for specific set up information.

Status:	Stop	Current Line/Hole:	00000 / 00000
SetArc:	146.0	ActualArc:	000.0
● IHS Check			s
● ArcTime			s
● Pierce			s
● TorchUp			s
● TorchDn			s
● LockTHC			
● ARC Feedback			
● IHS Signal			
[2/3] Pierce Time	0.5	[0] Manual THC	
[5/6] IHS Up Time	0.30		
[X] CutSpeed	1600.00	[N] Kerf	1.00
[Y] ManualSpd	9000.00	Angle	0.00
[F] Manual	KeepMov		
[G] StepDis	5.00	[M] Plasma Cut	
X: +000000.0		Pierce	44
		Length	7.23
Y: +000000.0		Cut Time	00:04:01
		Run Time	00:06:44
se	F6 Zoom In	F7 Manual Move	F8 Zero

All cutters as tested will work in either Manual or Auto THC.



## CUTTING PARAMETER PROCEDURE

This is the procedure used to determine the setting use create the best possible cut.

1. Verify that the material is clean and free of oil, paint, and rust.
2. Verify that the ground clamp is clamped directly to the material to be cut.
3. Starting with the settings in the chart (from the plasma cutter) do a test cut with **voltage control turned off** so you cut at the fixed cut height.
4. Make sure your test piece is **flat** in the area you are cutting. A 3 inch square works for starters.
5. If it doesn't pierce all the way thru at the beginning – increase the pierce time.
6. If it pierces but then “rooster tails” during the cut – reduce the cut speed.
7. If the cut edges have dross on them that can be easily chipped off – increase the cut speed until it “rooster tails” then back off the speed until the rooster tail just goes away – you now have the best speed.
8. Now using those pierce time and cut speed **adjust the cut height** until the edge bevel is the best you can get.
  - a. If the edges are **narrow at the top** like a pyramid then the torch is too low so raise the cut height.
  - b. If the edge is **narrow at the bottom** lower the cut height.
9. Now, still with **voltage control turned off**, make one final cut in a straight line for about 6 inches. While it is cutting observe the arc voltage – that is your new arc voltage setting for this amperage, material, speed and height.
10. Finally measure the width of the cut and that is your new kerf setting to enter into the cnc.





## Cutting Height

An automatic height control system is invaluable when plasma cutting with a mechanical torch. Using it can provide the proper cutting height for various material thicknesses when transferring the arc, piercing, and cutting. Below are some examples of how the torch height can affect the cut.

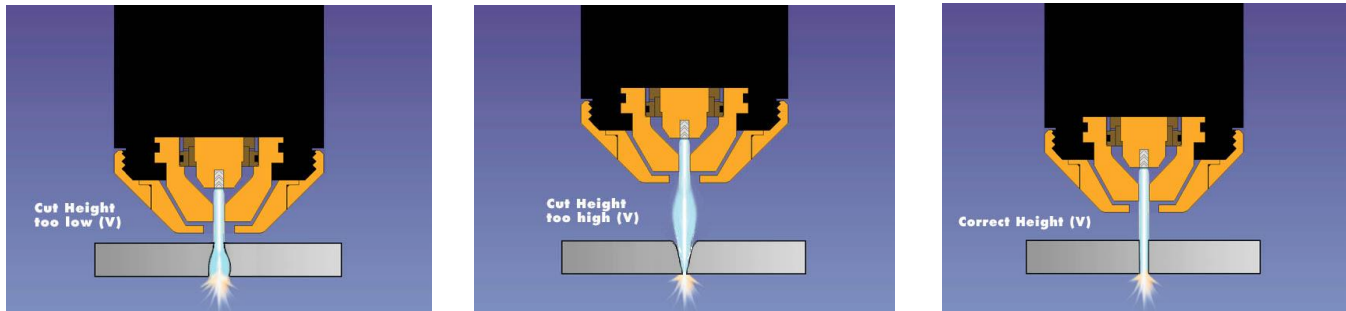

## Arc Voltage

A DC voltage can be measured between the negative electrode and the positive plate during cutting. This voltage will vary depending on the length of the arc between the electrode and the plate. A longer arc will show a higher voltage and a shorter arc will show a lower voltage. This is an effective way to measure torch to workpiece distance. A plasma system height control has a reference voltage set by the machine operator. Each plasma torch manufacturer provides these arc voltages which are dependent upon material, thickness of material, and the plasma process power level. As soon as the plasma process starts cutting the material, the torch height control looks at the actual arc voltage. It compares this with the arc voltage that was set on the AHC controller by the operator. Then the torch height control adjusts the up/down "Z" axis until the reference arc voltage and the actual arc voltage are the same, thereby controlling the distance between the torch and the workpiece. Any warping issues of the material will now be adjusted for automatically.

Listed below are a few things that can also affect the distance between the torch and the workpiece.

- Changes in cutting speed.
- Any fluctuations of the gas or air pressure.
- Crossing an existing kerf.
- Timing of the arc voltage.
- Wearing out of consumables.



## LUBRICATION AND MAINTENANCE



**WARNING:** Make sure the electrical disconnect is OFF before working on the machine.

Maintenance should be performed on a regular basis by qualified personnel.

Always follow proper safety precautions when working on or around any machinery.



*Note: Proper maintenance can increase the life expectancy of your machine.*

### Daily Maintenance

- Check daily for any unsafe conditions and fix immediately.
- Check that all nuts and bolts are properly tightened.
- On a weekly basis clean the machine and the area around it.
- Lubricate threaded components and sliding devices.
- Apply rust inhibitive lubricant to all non-painted surfaces.
- Do a general cleaning by removing dust, metal powder, and metal scrap from the table.
- Inspect the torch consumables for wear, and clean or replace as necessary.
- Check that the control console circulating fans are working and the emergency stop button is in good working order.

### Weekly Maintenance

- Thoroughly clean the machine.
- Check any exposed electrical wiring for wear or damage.
- Inspect the power unit ground clamp for wear or damage.

### Monthly Maintenance

- Tighten any loose bolts, nuts, or screws on the machine.
- Re-grease the gear racks for the "X" & "Y" axes.
- Re-grease the slide bearings that have fittings.
- Inspect the timing belts for wear (every 6-12 months).



# ELECTRICAL DIAGRAM

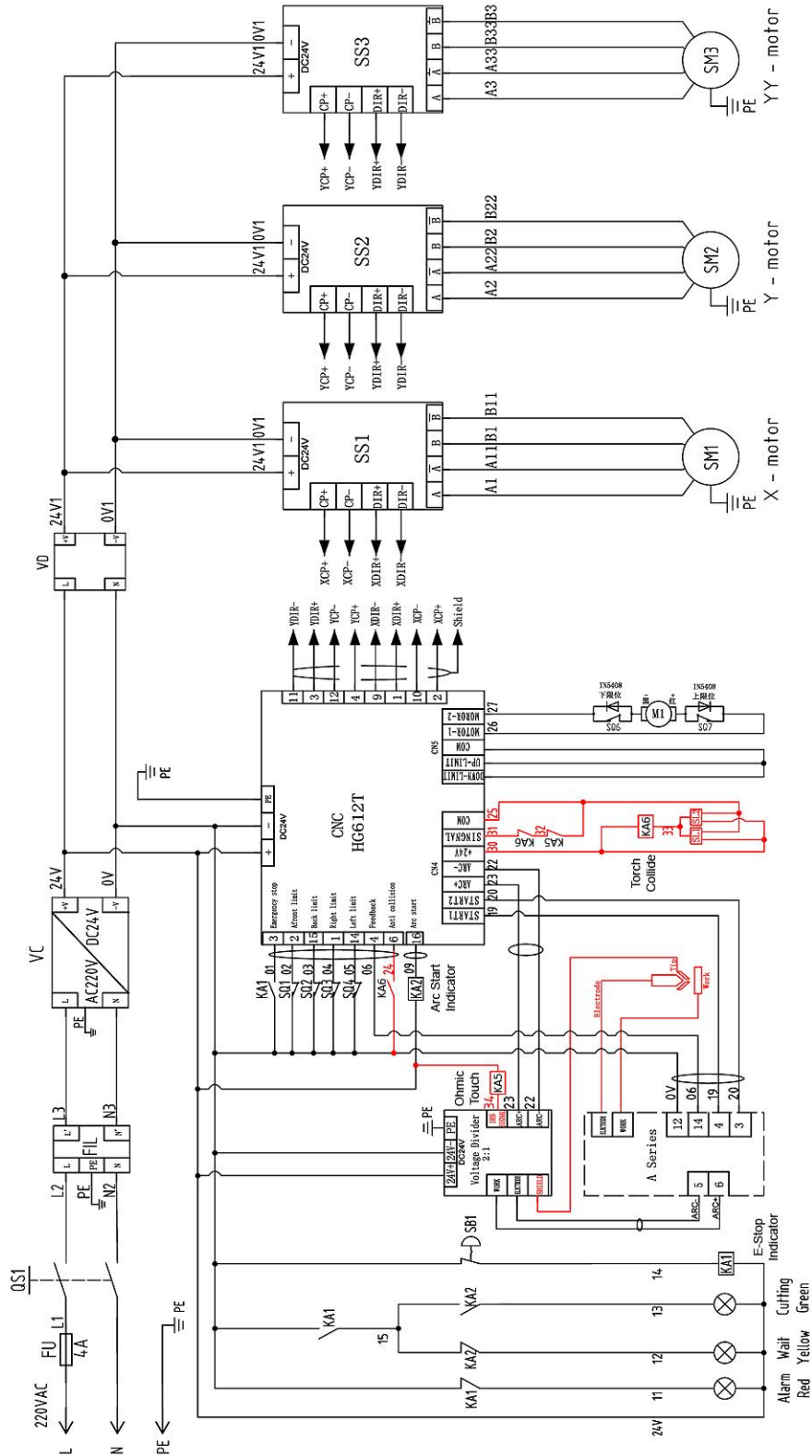



## **SOFTWARE INFORMATION**

Each new cutting table comes with one license of the latest version of BobCAD CAM Express software and Services provided by BobCAD-CAM.

Contact a representative from BobCAD-CAM to get started with BobCAD-CAM. The service representative will help to get you directed to the download links and the license activated.

Whether drawing squares or squirrels, flanges or flowers, BobCAD-CAM will help to bring out your drafting artistry skills. Practice and Have Fun!

BobCAD-CAM Vxx (latest version) Express (Covers: Mill, Laser, Plasma, and Waterjet) This software is best for 2D/3D CAD and 2 axis shape cutting.

- DXF DWG IGES & More
- Shape Library, Stretch, Splines, Snap Grid
- Hole Patterns Gears CAMS Sprockets
- Profiling, Kerf Comp, Lead in/out, Backplotting
- Post Processor

### **BobART**

This software is best for image conversions and embossing.

- EPS AI PDF
- JPEG, BMP, Tiff, GIF, PNG, PSD, and more....
- Vectorize (convert images)
- Embossing, Texture, Smoothing
- V carving

### **1 Hr of Online Line Training**

This training is best to learn BobCAD-CAM Fast.

- One on One web training
- Your Parts
- Your Questions
- Your Office
- Video Recording of Training Session

### **1 Year Technical Support Package**

This support package will get you started.

- Expert Technical Support
- Starts from Day of Purchase
- Phone & Email
- Remote Access (connecting computers)

### **BobCAD-CAM Contacts:**

Licensing, Support  
727-489-0003  
[support@bobcad.com](mailto:support@bobcad.com)

Sales, General Inquiry  
844-529-0660  
[partners@bobcad.com](mailto:partners@bobcad.com)



Use the information below to ensure you are working with a BobCAD-CAM supported and optimized system.

Use the following link to view the most up to date system requirements.

[http://bobcad.com/support/system-requirements/?source=webinars\\_footer](http://bobcad.com/support/system-requirements/?source=webinars_footer)

BobCAD-CAM is supported to run on the following Operating Systems:

- Windows 7
- Windows 8
- Windows 10

A 64 Bit System is needed.

BobCAD-CAM System Requirements

- Windows (Minimum)
- 64-bit Operating System
- 3GB RAM
- 256 MB Graphics Card\* that supports OpenGL 1.1
- Intel® or AMD® Processors\*\*
- 2GHz Processor
- Windows 10, Windows 8 or Windows 7
- Windows Indexing Service Must Be Enabled
- IE9 or above

Windows (Recommended)

- 6GB RAM or More on Windows 8 x64 Operating System
- 1GB Graphics Card\*
- Intel® or AMD® Processors\*\*
- 2GHz Processor (Multi-core) or higher
- Windows 10



**Note:**

*\*BobCAD-CAM's stability is dependent on the graphics card ability to process information; integrated memory graphics cards may work but are not recommended.*

*ATI® or NVIDIA® graphics cards with dedicated memory are recommended. The graphics card's software driver must be updated to the current software drivers released by the graphics card manufacturer.*

*\*4K displays are not currently supported and may require reducing your screen resolution.*

*\*\*BobCAD-CAM is not supported on Apple Macintosh® -based machines. Some customers have shown success in running BobCAD-CAM in a Virtual Windows environment on Mac computers using Boot Camp. While the end user may choose to run Windows on a MAC®, this is not supported by BobCAD-CAM Inc.*



NOTES



## PT-48AH-W QUICK REFERENCE GUIDE

### PT-48AH-W QUICK REFERENCE GUIDE

#### LOAD FILE

- From Main Menu → F2 File
- → F1 DISK FILE (System Storage)
- OR
- → F2 U DISK (USB Storage)
- ↑↓ Highlight desired file → F8 OK.

#### SET ORIGIN POINT

- From Main Menu
- [X-] [X+] [Y-] [Y+] (keyboard arrow keys) Move torch to desired origin / start point → F8 ZERO.
- Location now Zeroed.

#### CHANGE CUT SPEED

- Before Program is started, Press X key → enter mm/min. speed from plasma cutter charts or past notes → Enter to save.
- During the cut, press F4 to slow down. Press F5 to speed up.

#### CHANGE CUT SETTINGS

- FROM Plasma Power Supply Manual Cutting Table. Match the materials with the cutting amperage and the consumables.
- Set the cut speed.
- Set the cut Arc Voltage. Press the Space Bar → Press F6 to decrease value. Press F7 to increase value.
- Set Pierce time. Press 2 key to decrease value. Press 3 key to increase value. (.1sec per press).
- Set Position Up time. Press 5 key to decrease value. Press 6 key to increase value. (.1sec per press).

#### RUN PROGRAM

- Plasma cutter is On, with correct consumables, clean dry air at the correct pressure and volume.
- Press Start to start the program.
- Press Stop to pause or stop the program. (Start will resume)

#### HELPFUL KEYS

- ESC key. Cancels commands and/or moves back a screen.
- SPACE BAR. Shows additional function key options.



**BAILEIGH INDUSTRIAL HOLDINGS LLC**  
**1625 DUFEEK DRIVE MANITOWOC, WI 54220**  
**PHONE: 920. 684. 4990 FAX: 920. 684. 3944**  
**[www.baileigh.com](http://www.baileigh.com)**

**BAILEIGH INDUSTRIAL HOLDINGS LTD. UNIT D SWIFT POINT**  
**SWIFT VALLEY INDUSTRIAL ESTATE, RUGBY**  
**WEST MIDLANDS, CV21 1QH UNITED KINGDOM**  
**PHONE: +44 (0)24 7661 9267 FAX: +44 (0)24 7661 9276**  
**[WWW.BAILEIGH.CO.UK](http://WWW.BAILEIGH.CO.UK)**