

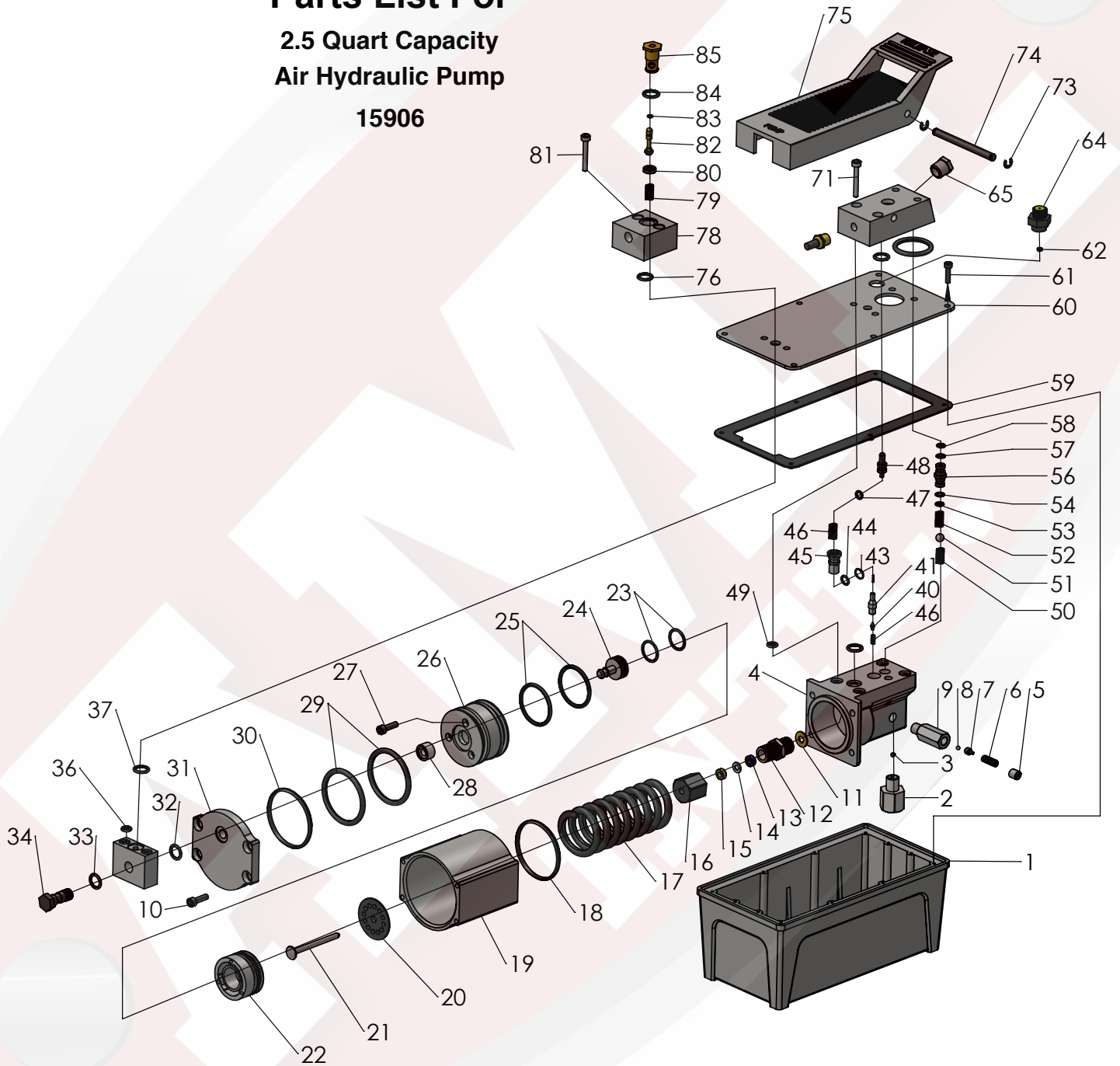

# PARTS BREAKDOWN

## Parts List For 2.5 Quart Capacity Air Hydraulic Pump 15906





# PARTS BREAKDOWN

## Parts List For 2.5 Quart Capacity Air Hydraulic Pump 15906

Item No	Part No	Description	Qty	Item No	Part No	Description	Qty	Item No	Part No	Description	Qty
1	15905-001	Oil reservoir	1	31	15905-031	Rear Cover	1	61	15905-061	Screw	12
2	15905-002	Oil Filter	1	32	15905-032	O-Ring	1	62	15905-062	O-Ring	2
3	15905-003	Oil Filter	1	33	15905-033	O-Ring	1	63	15905-063	Oil Filter Plug	1
4	15905-004	Valve Block	1	34	15905-034	Bolt	1	64	15905-064	Oil Filter Plug	1
5	15905-005	Screw	1	35	15905-035	Fixing Base	1	65	15905-065	Screw	1
6	15905-006	Spring	1	36	15905-036	O-Ring	2	66	15905-066	Oil Filter	1
7	15905-007	Ball Seat	1	37	15905-037	O-Ring	1	67	15905-067	O-Ring	1
8	15905-008	Steel Ball	1	38	15905-038	O-Ring	1	68	15905-068	O-Ring	1
9	15905-009	Safety Valve	1	39	15905-039	Spring	1	69	15905-069	Exhaust Muffler	1
10	15905-010	Bolt	8	40	15905-040	Ball Seat	1	70	15905-070	Fixing Base	1
11	15905-011	CopperWasher	1	41	15905-041	Steel Ball	1	71	15905-071	Bolt	4
12	15905-012	Pump Cylinder	1	42	15905-042	O-Ring`	1	72	15905-072	Spring	1
13	15905-013	Y-Seal	1	43	15905-043	NylonGasket	1	73	15905-073	Snap Ring	2
14	15905-014	NylonGasket	1	44	15905-044	ReleaseValve	1	74	15905-074	Shaft	1
15	15905-015	CopperWasher	1	45	15905-045	Ball Seat	1	75	15905-075	Foot Pedal	1
16	15905-016	Nut	1	46	15905-046	Spring	1	76	15905-076	O-Ring	1
17	15905-017	Spring	1	47	15905-047	O-Ring	1	77	15905-077	Screw	1
18	15905-018	O-Ring	1	48	15905-048	Release Rod	1	78	15905-078	Air Valve	1
19	15905-019	Pump Housing	1	49	15905-049	O-Ring	4	79	15905-079	Spring	1
20	15905-020	Washer	1	50	15905-050	Steel Ball	1	80	15905-080	Seal	1
21	15905-021	Pump Plunger	1	51	15905-051	Spring	1	81	15905-081	Bolt	2
22	15905-022	Air PistonBase	1	52	15905-052	Steel Ball	1	82	15905-082	Air Valve Rod	1
23	15905-023	O-Ring	2	53	15905-053	Spring	1	83	15905-083	O-Ring	1
24	15905-024	AirValve Shuttle	1	54	15905-054	O-Ring	1	84	15925-084	O-Ring	1
25	15905-024	O-Ring	2	55	15905-055	NylonGasket	1	84	15905-085	Seitch Coupler	1
26	15905-026	Piston	1	56	15905-056	Coupler	1				
27	15905-027	Bolt	3	57	15905-057	NylonGasket					
28	15905-028	ShuttleValve Seal	1	58	15905-058	O-Ring	1				
29	15905-029	O-Ring	2	59	15905-059	Seal					
30	15905-030	O-Ring	1	60	15905-060	Cover					

2347 Circuit Way, Brooksville, Florida, USA 34604  
 Phone: (+1) 352-799-1111 Toll Phone: (+1) 877-775-4AME (4263)  
 Fax: (+1) 352-799-1112 E-mail: sales@ameintl.net www.ameintl.net