



CEMB

BALANCING MACHINES

EN

Use and maintenance manual

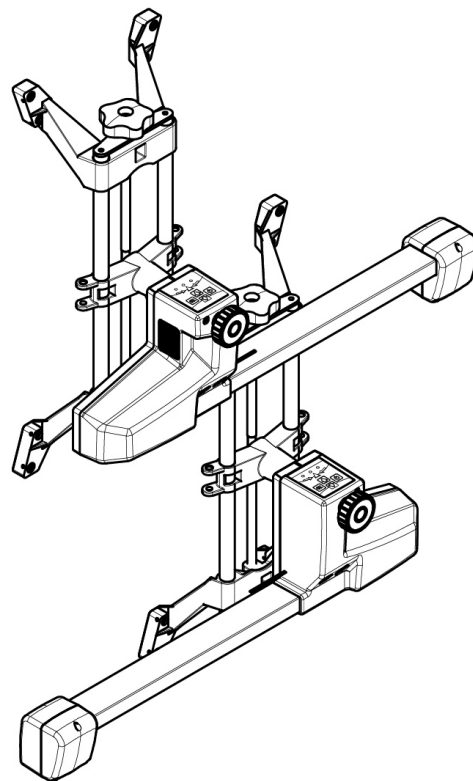
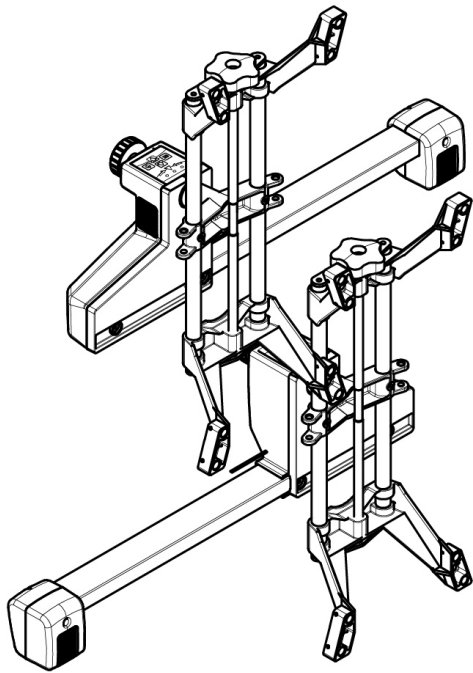

DWA1100

CEMB S.p.A.

Via Risorgimento, 9

23826 Mandello del Lario (LC) ITALY

Telefono: + 39 706369 Fax: + 39 0341 700725

www.cemb.com garage@cemb.com

The Manufacturer declines all liability for any damage to people or property caused by incorrect use of this product.
Subject to change without prior notice.



Istruzioni originali

Translation of the original instructions

Traduction de la notice originale

Übersetzung der Originalanweisungen

Traducción de las instrucciones originales

Tradução das instruções originais

CONTENTS

CAUTION!	3
GENERAL WARNINGS	3
PRECAUTIONS AND INSTRUCTIONS FOR SAFETY, USE AND MAINTENANCE	3
MACHINE DESCRIPTION	5
TECHNICAL DATA	5
COMPONENTS	5
1 - MACHINE USE	7
1.1 - BATTERY AND COMMUNICATION STATUS	7
1.2 - RECHARGING THE BATTERIES	8
2 - PROGRAM FLOW	9
2.1 - HOW TO INTERACT WITH THE PROGRAM	10
3 - PREPARING FOR MEASUREMENT	11
3.1 - HOME PAGE	11
3.2 - SETTINGS	13
3.3 - CUSTOMER DATABANK	16
4 - VEHICLE SELECTION	17
4.1 - SELECTING A VEHICLE	17
4.2 - CUSTOMER INFORMATIONS	17
5 - VEHICLE SPECIFICATIONS	19
5.1 - ADJUSTMENT HELP IMAGES	20
5.2 - RIDE HEIGHT	21
5.3 - LOADS	22
5.4 - VEHICLE CUSTOMISATION	22
5.5 - (TRUCK ONLY) AXLE CONFIGURATION	24
5.6 - FIT AND ALIGN THE BAR ON THE FIFTH WHEEL PIN	25
6 - RUNOUT	26
6.1 - HOW TO EXECUTE RUNOUT	28
6.2 - 180° OR 90° RUNOUT ON THE GROUND	29
6.3 - 180° RUNOUT LIFTED	31
6.4 - 3X90° RUNOUT LIFTED	32
7 - STEERING	33
7.1 - FAST STEERING	34
7.2 - 10° OR 20° STEERING	34
8 - DIAGNOSTICS	35
9 - ADJUSTMENT	36
9.1 - ADJUSTMENT PROCEDURES	37
9.2 - (CAR) ADJUSTING A REAR AXLE	37
9.3 - ADJUSTING A FRONT AXLE	38
9.4 - (TRUCK) ADJUSTING A REAR AXLE	41
9.5 - (TRUCK) ADJUST THE PARALLELISM BETWEEN THE TWO FRONT STEERING AXLES	42
9.6 - (CAR) ADJUSTING THE FRONT TOE-IN WITH THE VEHICLE RESTING ON A SUPPORT (TOE-IN CURVE - VAS PROCEDURE)	43
9.7 - ADJUSTING WITH THE WHEELS RAISED OR STEERED (FREEZING)	44
9.8 - ADJUSTMENT IN CASE OF INTERRUPTION OF THE INFRARED RAYS	45
10 - SUMMARY	46
10.1 - VEHICLE DIMENSIONS	47
10.2 - MAXIMUM STEERING	47
11 - WHEEL ALIGNMENT AND MEASURING HEAD LEVELLING	48
12 - SPOILER	49

13 - MAINTENANCE	51
13.1 - CLEANING	51
13.2 - HOW TO ACTIVATE THE DATABANK AND THE SOFTWARE	51
14 - TROUBLESHOOTING	53
14.1 - MALFUNCTIONS	53
14.2 - ALIGNMENT PROBLEMS	55
15 - STORING AND SCRAPPING	57
15.1 - STORING	57
15.2 - SCRAPPING	57
16 - TESTING THE MEASURING HEADS BY FITTING THEM ON THE VEHICLE	58
16.1 - MEASUREMENT I - TOE-IN AND CAMBER IN DRIVING DIRECTION	58
16.2 - MEASUREMENT II - TOE-IN AND CAMBER IN REVERSE DRIVING DIRECTION	58
16.3 - EVALUATION OF THE VALUES MEASURED DURING THE MEASURING HEAD TEST	58

► General warnings

- The manual refers to the essential requirements set out in the directives, standards and provisions pertaining to use of the machine summarising the most significant points.
- In addition to the service instructions, the general rules of law and the binding rules regarding the prevention of accidents and protection of the environment must be observed.
- For all the work to be carried out with or on the machine, the following provisions must be complied with as well as the general safety regulations following the instructions.
- The user must ensure that the machine is always and only used in perfect condition taking into account the essential safety requirements and the applicable regulations.
- The machine must immediately be put out of service if any defects or malfunctioning is found.
- Only trustworthy persons may work with the machine; the user is responsible for ensuring that the persons assigned to the job are suitably qualified and trained.
- For any doubts about use and maintenance of the machine, consult this manual; if necessary, contact the authorised technical service centres.

► Precautions and instructions for safety, use and maintenance

- The data plate bearing the voltage and frequency data is affixed on the rear of the machine. **NEVER CONNECT THE MACHINE TO A VOLTAGE OR FREQUENCY OTHER THAN THOSE INDICATED.**
- The machine is equipped with a 3-wire plug with incorporated earth to be inserted only in an earthed socket. If it is not possible to fit the plug in a socket of this kind, please consult an electrician.
- Do not modify or improperly use the plug.
- This machine is not equipped with a manual power cutting device. To cut the power, pull out the plug or turn off the main switch positioned upstream.
- All the operations on live electrical parts must be performed after turning off the power switch on the electric cabinet.
- Do not remove or make unrecognizable the danger warning plates, adhesive labels and markings on the machine and make sure that they are always legible.
- All the maintenance and inspection operations must exclusively be carried out by qualified persons.
- Mechanical and electrical repairs as well as setting operations may only be carried out by qualified persons.
- Unauthorised persons must be prohibited from performing any work on the machines and equipment of the system.
- In the event of significant faults that may compromise the safety and/or reliability of the machine, it must be stopped and in any case not started before the faults have been corrected.
- It is prohibited to transform or make modifications to the electric system.
- The user will be held responsible for any damages as a result of such modifications. In case of doubt, please contact the manufacturer before making any modifications.
- Exclusively use original fuses with the specified capacity in ampere! In the event of electrical power supply faults, the machine must immediately be turned off.
- Defective fuses may not be repaired or deactivated, but must be replaced with fuses of the same type.
- Comply with the environmental protection regulations when disposing of waste substances or replaced parts.

The wheel aligner is a machine intended for measuring the characteristic angles of motor vehicles, in particular, the camber, toe-in and caster.

► Technical data

Power supply and consumption

Measuring cabinet

Power supply:	230 VAC single-phase 50/60 Hz 115 VAC single-phase on request
Max power absorbed:	0,46 kW
Max current absorbed:	2 A - 230V 4 A - 115V

Measuring heads

Internal power supply:	7.2 V rechargeable batteries (Li-Ion)
------------------------	---------------------------------------

► Components

Measuring heads

The measuring heads are made up of CCD transducers to measure the horizontal angles and accelerometers to measure the vertical angles. The power is supplied by rechargeable batteries; when the batteries are flat, measurements can still be made by connecting the battery charge cables - supplied as option and not included in the standard equipment - to the measuring heads. To turn on the measuring heads press any key on the keypad.



The measuring heads turn off automatically after about 15 minutes if no data is transmitted.



1. Keyboard
2. 3 LEDs for measuring head levelling
3. Connector for battery charge cable
4. Pin locking knob

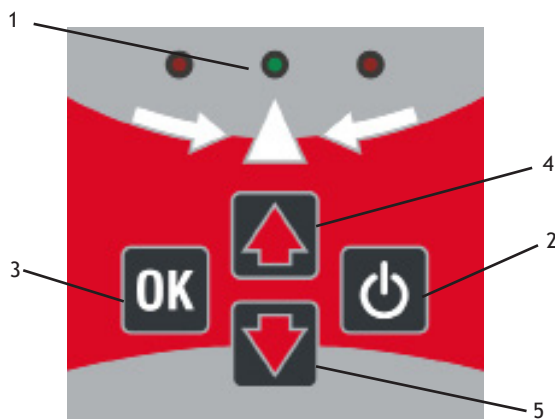

1. Level indicator with red/green/red LED

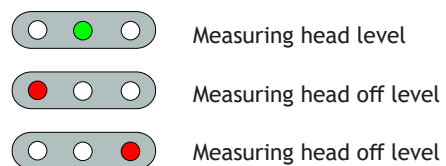

2. Power on/off
3. OK
4. Next page
5. Previous page

Turntables

Plate diameter: 310 mm Capacity: 1000 kg each.

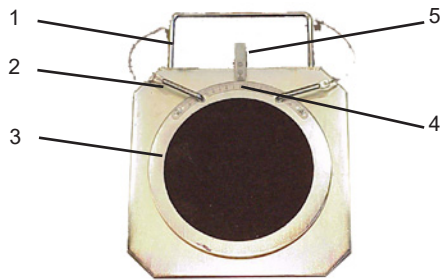

1. Handle
2. Off
3. Plate with non-slip disc
4. Goniometer
5. Reference dial



(option only for car) - Premium type turntables.



Brake pedal lock

This device is used to lock the brake pedal while preparing to make a measurement.

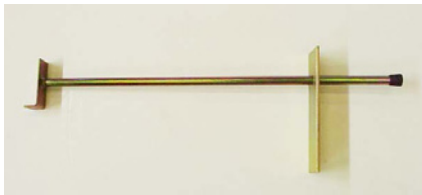

Steering lock

This device is used to hold the steering wheel in a fixed position; it is positioned before carrying out the vehicle adjustment operations.



► 1.1 - Battery and communication status

On some pages battery icons are displayed, which indicate the status of the batteries and the communication between the computer and the measuring heads.

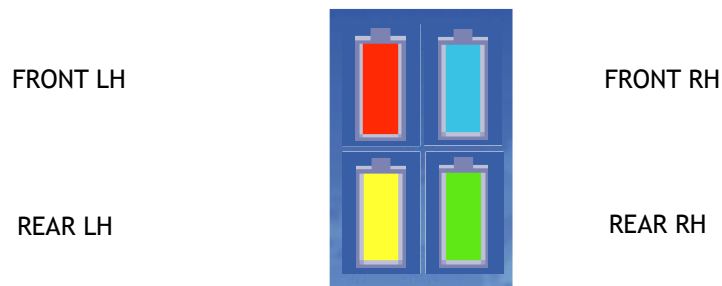

The colour of the battery icons indicates the status of the battery charge:



- Light blue: battery recharging or almost fully charged
- Green: battery charged
- Yellow: battery low; estimated operating time 60 minutes
- Red: battery flat estimated operating time 30 minutes
- Grey: no communication
- Black: rear measuring head not used in the 2 measuring heads mode

► 1.2 - Recharging the batteries

To recharge the measuring head batteries:

1. Check that the battery power switch is set to (I)

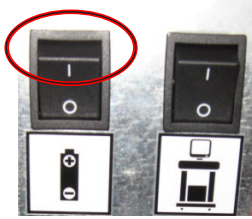

2. Connect the measuring heads to the power cables

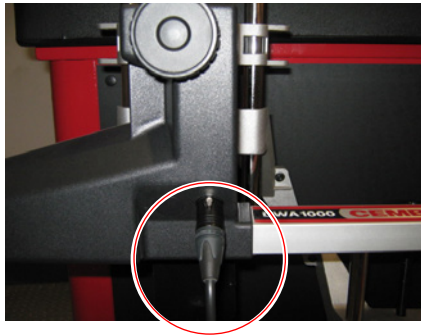

Recharging is indicated on the screen by the blue battery icons and on the measuring head by the keypad LEDs flashing in sequence and automatically ends after about 5 hours if the battery is completely flat. It is not necessary to wait for the batteries to go completely flat before recharging them. The battery life in typical operating conditions is 24 hours of operation, but could be less when the temperatures are low.



- If the measuring heads are not used for a long period of time (more than a week), it is advisable to disconnect them from the power supply.
- Conditions of validity of the battery warranty
Recharge the batteries at least once every 6 months; a partial recharge (50%) is sufficient.
- Operate in a temperature range between 0° and + 45° C.



PRECAUTIONS FOR USE OF THE BATTERIES

- **DO NOT LEAVE THEM NEAR HEAT SOURCES SUCH AS FIRE, HEATERS, DIRECT SUNLIGHT**
- **DO NOT DISASSEMBLE OR PIERCE THEM WITH SHARP OBJECTS**
- **DO NOT SHORT-CIRCUIT THEM AND DO NOT INVERT THE POSITIVE AND NEGATIVE POLES**
- **KEEP THEM IN A DRY PLACE AND DO NOT IMMERSE THEM IN WATER**
- **DO NOT EXPOSE THE BATTERY TO HIGH EXTERNAL PRESSURES, WHICH MAY CAUSE AN INTERNAL SHORT-CIRCUIT OR OVERHEATING. IN CASE OF IMPACT OR DROPPING, DO NOT REUSE THE BATTERY AND PROPERLY DISPOSE OF IT.**

IN CASE OF FIRE CAUSED BY A LITHIUM BATTERY:



- **DO NOT INHALE THE TOXIC VAPOURS CAUSED BY LITHIUM COMBUSTION**
- **EXTINGUISH THE FIRE USING A CLASS D OR GRAPHITE POWDER-BASED (LITH-X) FIRE EXTINGUISHER**

2 - PROGRAM FLOW

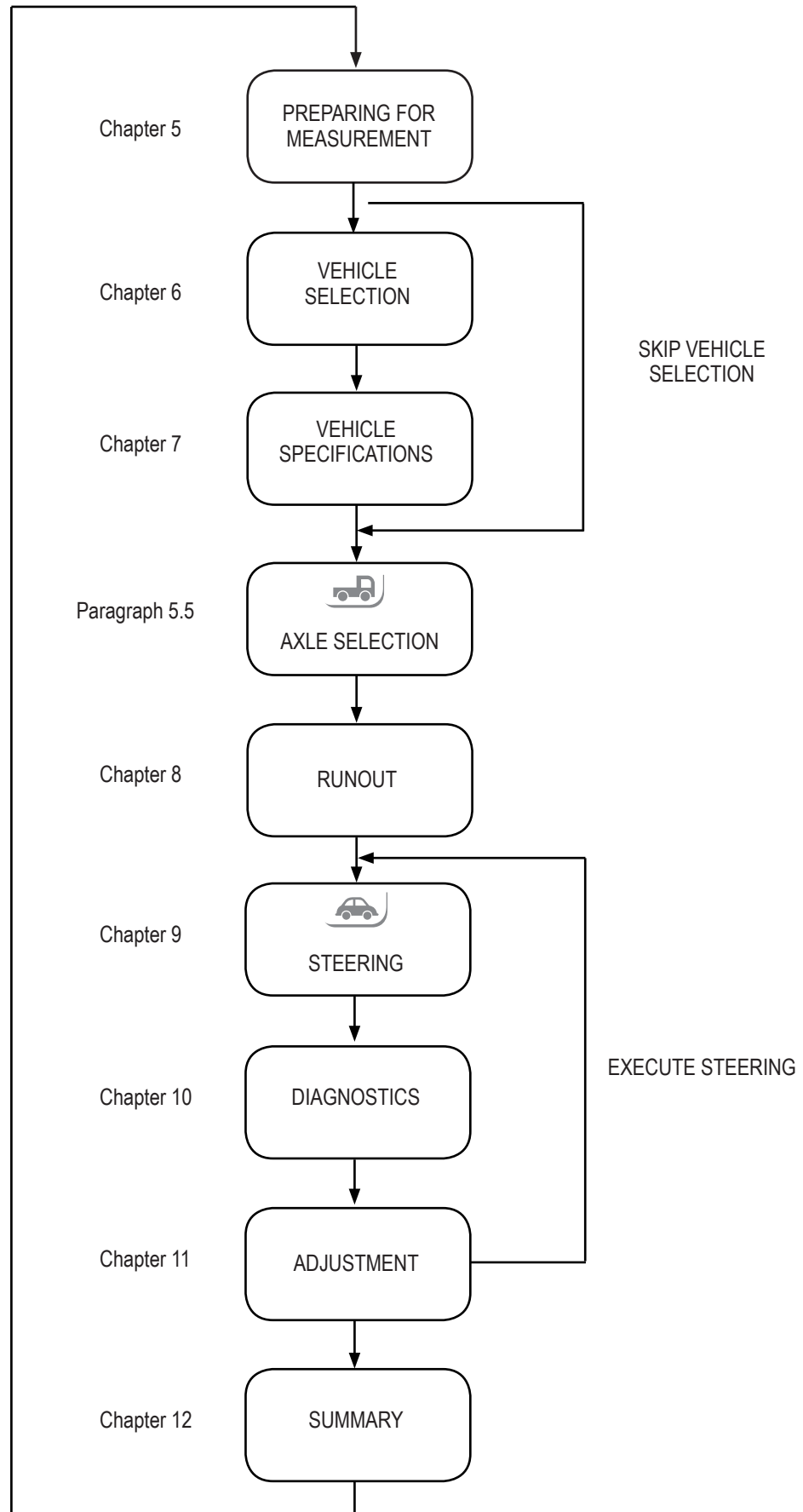
The following flow chart schematizes the typical program flow for a car or truck with only two axles. In case of trucks with more axles certain operations must be repeated.











► 2.1 - How to interact with the program

The operations indicated by the on-screen keys F1 ... F7 can be performed by clicking on or pressing ...  on the keyboard or pressing the arrow buttons of the measuring head keypad.



On the normal pages:





- | | | | | |
|---|-----|---|---|---|
|  | ... |  | : | the function of these keys varies from page to page |
|  | or |  | : | goes back to the previous page |
|  | or |  | : | goes to the next page |
|  | | | : | help |
|  | | | : | goes back to the home page |

In the menus:



- | | | | | |
|---|-----|---|---|-----------------------------|
|  | ... |  | : | select the desired function |
|  | | | : | exits from the menu |



- You can move between the pages using the measuring head keypad.
- To continue with the alignment procedure press  or 

3 - PREPARING FOR MEASUREMENT

► 3.1 - Home page

The home page appears at the beginning of each alignment procedure.

From this page you can select:

- the car and truck alignment procedure (if enabled)
- the measuring mode with 2 or 4 measuring heads.

The measuring mode with 2 measuring heads allows measuring and adjusting only the toe-in and camber of the front axle. The measuring mode with 4 measuring heads is faster because you do not have to fit the rear measuring heads.



It is recommended that only experts use the mode with 2 measuring heads as it is not guaranteed that the steering wheel stays straight.

Generally, when the home page is displayed, the preliminary operations on the vehicle are performed.

To prepare for measurement:

1. Position the vehicle on the turnplates
2. Mount the wheel clamp and the measuring heads on the vehicle wheels
3. Turn on the computer
4. Turn on the measuring heads











If HYBRID mode is active:



Measuring heads positioning:

- a. Sensor type CAR
- b. Sensor type TRUCK

-  : switch between the car or the truck procedure
-  : switch between the mode with 2 or 4 measuring heads
-  : menu
-  : settings page
-  : customer databank page
-  : test
-  : calibration
-  : goes directly to measurement without selecting the vehicle

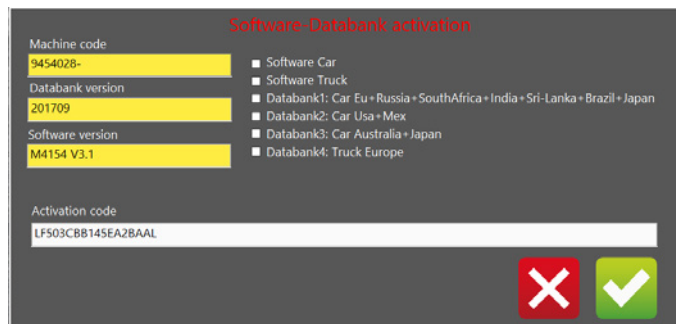

If the databank activation window appears on the home page the databank must be activated  13.2

Nevertheless, the databank can be used for a limited number of times without activating it. To do this, press

 to close the activation window.





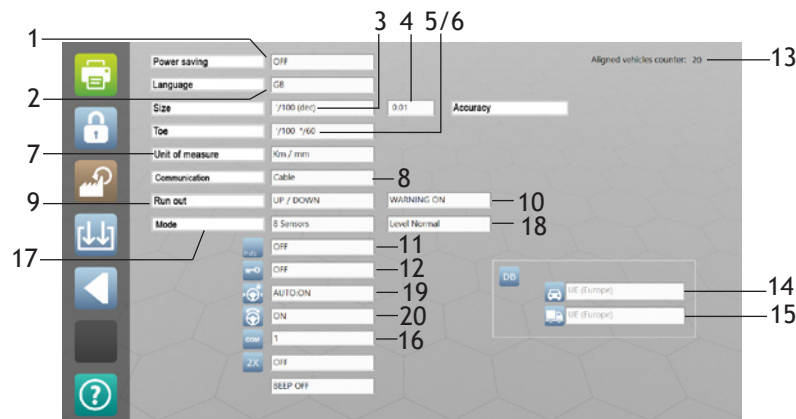







► 3.2 - Settings

To access this page from the home page press **F3** and then **F1**.







The following parameters can be set:



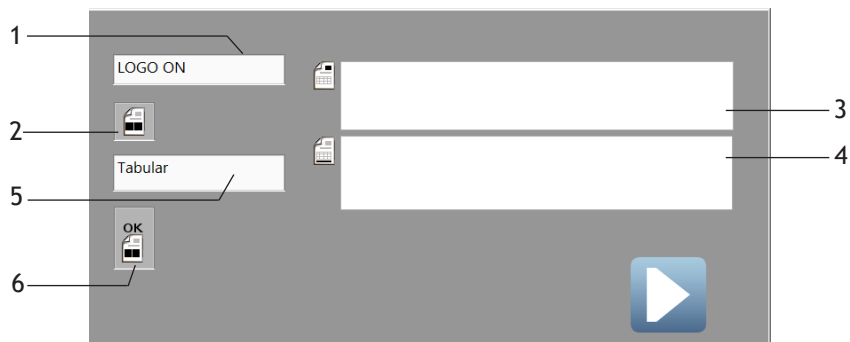



- Time of inactivity after which the measuring heads go into standby to reduce battery consumption (infrared LEDs off).
- Language
- Format of the fractions of an angle
 - '/100 (dec) = hundredths of a degree (centesimal degrees)
 - °/60 (min) = sixtieth of a degree (sexagesimal degrees)
- Angle resolution shown on the display (the actual resolution of the instrument does not change)
- Toe-in format and resolution
 - '/100 °/60 = degrees, resolution specified in box 3
 - mm = millimetres, resolution specified in box 4
 - inch (dec) = inches, resolution in tenths of an inch
 - inch (1/4) = inches, resolution in fourths of an inch
 - inch (1/64) = inches, resolution in sixty-fourths of an inch
- Toe-in resolution if expressed in millimetres or inches
- Distance unit of measure
- Type of communication between the measuring heads and the computer ('Cable' = via cable) 'BT' = Bluetooth; 'BT2' = Second generation Bluetooth)
- Type of runout permitted ('UP/DOWN' = both lifted and on the ground; 'UP' = lifted only; 'Bypass' = runout execution not required)
- Enables checks on correct runout execution
- Help texts:
 - OFF: disabled
 - ON: displays on the screen buttons their name
 - ON+INF: displays the previous and pages titles
- Settings page password ('ON' = password required to access the Settings page)
- Number of alignments executed
- Car database active
- Truck database active
- COM port setting ⚠ do not change (reserved for technical service).
- In IBRIDA or HYBRID mode (*): measurements made with all the sensors (8 sensors) or disabling the rear toe-in sensors (6 sensors). This second setting is useful in order to be able to make a measurement also if the rear toe-in radius is interrupted. * The measurement execution mode requires the use of 2 CAR sensors and 2 TRUCK sensors.
- (🚗) Level sensor tolerance. Select the 'Normal' setting to optimise measurement accuracy. Use the 'Wide' setting only if you have difficulty keeping the measuring heads level, for example, when measuring with the engine on
- Option to disable caster measurement:
 - ON: steering required
 - OFF: steering not required
- Automatic next page for the brake pedal lock and steering lock positioning pages
 - AUTO ON: the next page is automatically displayed after 15 seconds
 - AUTO OFF: you need to press F6 to go to the next page

-  : print settings  *see below*
-  : databank/software activation  13.2
-  : reset to factory settings
-  : data export setting
-  : saves the settings and exits
-  /  /  /  /  : allow selecting and setting the various parameters

► **Print settings**



1. Logo ON/OFF
2. Colour in which out-of-tolerance values are printed
 -  : measurements before and after adjustment red
 -  : measurements before and after adjustment black
 -  : only measurements after adjustment (black)
3. Printer header
4. Print footer
5. Print mode
 1. Tabular
 2. Graphic
6. Values within tolerance green/black

-  /  /  /  /  : allow selecting and setting the various parameters
-  : saves the settings and exits

► **Data export setting**



It is possible to save automatically and daily any single alignment anywhere in the network. Any file contains the complete daily measurements before and after adjustment.

How to set it:

- Create a new folder where wished to save the data. Any accessible path in the network can be used.
- Enter the SET-UP page and select the DATA EXPORT icon ()

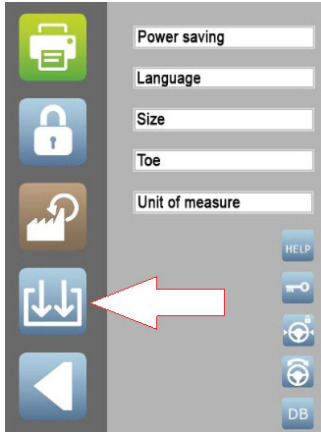

- Click on ENABLE (LED must be on)
- Browse to the folder previously created
- *Optional:* insert the aligner serial number. It will be saved with the data.

► 3.3 - Customer databank

To access this page from the home page press **F3** then **F2**. From this page you can search for and display the customer informations and the relative vehicles measurements stored previously. You can search the data by customer name, vehicle license plate, date or work order. You can also backup or restore all the user data (customer informations and relative vehicles measurements + customized vehicles).

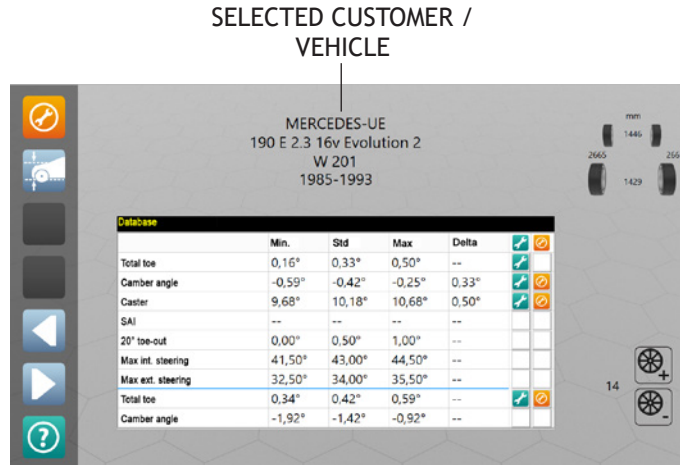

- F1** : displays the list of customers/vehicles corresponding to what was entered in the search box
- F2** : deletes the customer/vehicle selected
- F3** : backup *see below*
- F4** : restore *see below*
- Tab** : selects the search box or the customer list
- / : select the desired customer
- F6** : displays the customer measurements of the selected customer

To backup the user data:

1. Plug a USB memory into a free USB port.
2. Press **F3**. The user data is copied to the USB memory
3. Copy the user data files from the USB memory to a safe location on another computer

To restore the user data:

1. Copy the user data files to a USB memory
2. Plug a USB memory into a free USB port
3. Press **F4**. The user data is copied to the computer

You can also use this method to transfer the user data from one alignment machine to another.



Restoring the user data deletes any user data already on the computer.

4 - VEHICLE SELECTION



► 4.1 - Selecting a vehicle

The Vehicle Selection page allows selecting a vehicle so that during adjustment you can compare the measurements with the manufacturer's specifications and display adjustment help images.



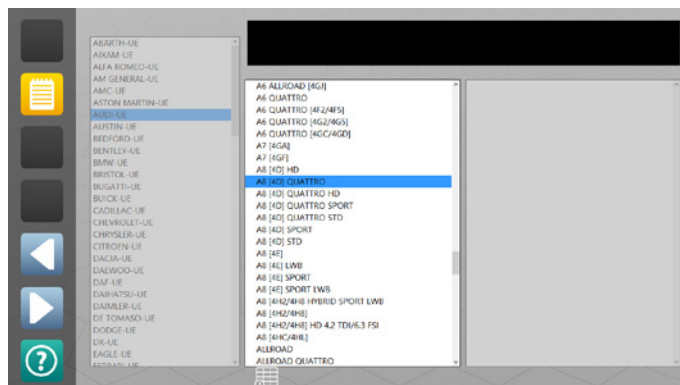

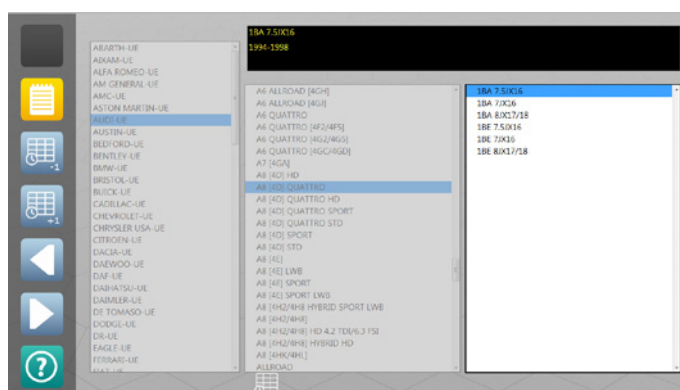

Select the vehicle first by manufacturer and then by model and sub-model. For faster selection of the model you can display only the models registered as of the year indicated.

You can also insert informations on a customer, which are saved in the customer databank together with the summary of the measurements so that they can be viewed and printed later.





-  : to enter informations customer
-  : to select the desired make
-  : confirms the make of the vehicle selected



-  : to insert customer informations
-  : decreases/increases the year of registration with which the models are filtered
-  : model selection
-  : previous page (vehicle make selection) .
-  : confirms the model selected and goes to the database
-  : help

► 4.2 - Customer informations

Press  to insert customer informations.



The screenshot shows a software interface with a dark grey background and a light grey grid pattern. On the left side, there is a vertical sidebar with several dark grey buttons. The main area contains a form with the following fields:

- Name
- Plate number/VIN
- Km
- Work order ID
- Technician

Below these fields is a large white text area labeled "Notes". A blue arrow button is positioned to the left of the "Notes" field.



: saves the informations and exits

5 - VEHICLE SPECIFICATIONS

The "Vehicle Specifications" page allows analysing the manufacturer's specifications to decide which operations are to be performed.

In most cases the manufacturer specifies the minimum, standard and maximum values for the main angles: toe-in, camber and caster.

Nevertheless, in some cases the manufacturer might:

- Require to position loads in the vehicle or fill the tank before making the measurement and adjustment
- Specify angles normally ignored: SAI, TOOT or maximum steering
- Specify the maximum values for the difference between the right and left wheel camber or caster
- (car only) Prescribe a special adjustment method, as the 'Toe-in curve'
- Give different specifications based on the measurements of the ride height or the inclinations of parts of the suspension.
- Check some vehicle measurements (e.g. ride height or component tightening torque) or apply special tools (e.g. toe-in bar) before making the measurement and adjustment

You can also set the rim diameter in order to correctly display the toe-in in millimetres or inches and customise the vehicle specifications.

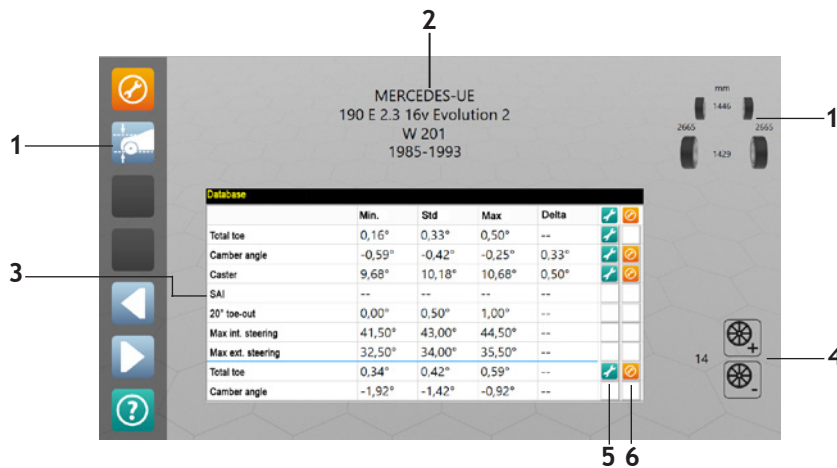

1. () Wheelbase and track; () Axles to which the specifications refer
2. Vehicle - make, model, sub-model or technical name, date of start and end of production.
3. Specifications. Minimum, standard and maximum values and maximum difference between the right and left wheels.
4. Rim diameter (inches)
5. If the wrench icon appears, the vehicle angle is definitely adjustable. If it does not appear, the angle might be adjustable any way.
6. If the camera icon appears during adjustment you can view the adjustment help images.



If you do not set the correct rim diameter when the toe-in is displayed in millimetres or inches, the measurement may differ from what is obtained when measuring the toe-in with a rule. Nevertheless, the rim diameter does not need to be set correctly in order to correctly adjust the vehicle; it is sufficient to position the indicator in the green zone during adjustment.

- : displays any Adjustment Help Images 5.1
- : displays the ride height page 5.2
- : displays the weights and percentage fuel in the tank 5.3
- + : allows creating a customised vehicle 5.4
- / : decreases/increases the rim diameter

► 5.1 - Adjustment help images

Selecting this option () a page is displayed showing the images of the mechanical adjustments that can be made on the vehicle being measured.

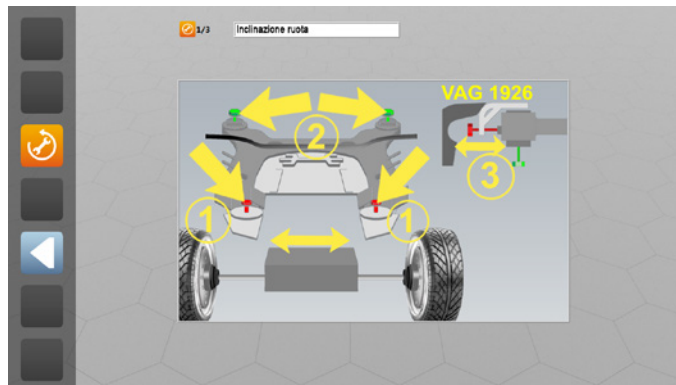

: displays the next image



: goes back to the Vehicle Specifications

► 5.2 - Ride height

To access this page, press **F2** from the Vehicle Specifications page

The Ride Height page allows:

- Viewing which measurements on the vehicle are required by the manufacturer (ride height or inclination of parts of the suspension) and if necessary enter the results.
- Viewing which measurements to check on the vehicle before making the measurement and the adjustment (e.g. chassis height or component tightening torque)
- Viewing which special tools to apply (e.g. toe-in bar)

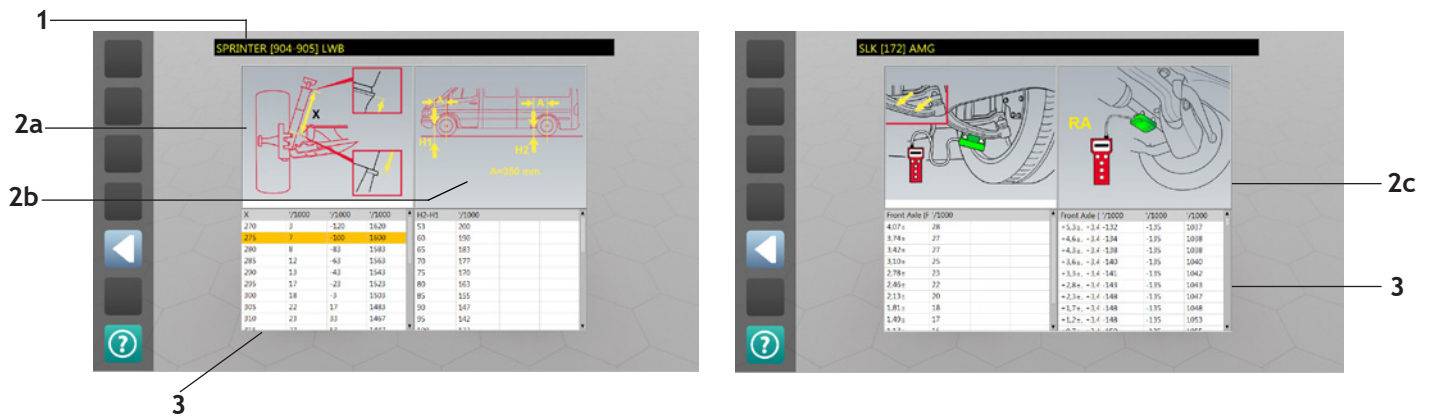

1. Vehicle
2. Images of the measurements to be made on the vehicle or the tools to be applied.
 - Examples:
 - a. Position the toe-in bar
 - b. Measurements with rule
 - c. Measurements with inclinometer
3. Tables

Once the tools have been applied and the measurements made, consult the tables.

- If they indicate that you need to check that the measurement is within a certain tolerance interval and this is not the case, act on the vehicle adjustments to bring the measurements within tolerance.
- If they indicate that you need to enter the measurement made, select the row from the corresponding table. The vehicle specifications are modified as a result.



You are advised to follow the manufacturer's indications; if it is required to set the measurement and this is not done, average values are used for the specifications.

Tab / **Shift** + **Tab** : selects one of the two tables

◀ / **▶** : selects the value of the measurement made on the vehicle (used only for tables that indicate that the modification selected must be entered)

F5 : goes back to the Vehicle Specifications page, if necessary changing the values of the vehicle angles based on the measurements made

► 5.3 - Loads

To access this page, press **F3** from the Vehicle Specifications page.

The Loads page allows viewing the loads to be positioned in the vehicle and the amount of fuel there needs to be in the tank as specified by the manufacturer.

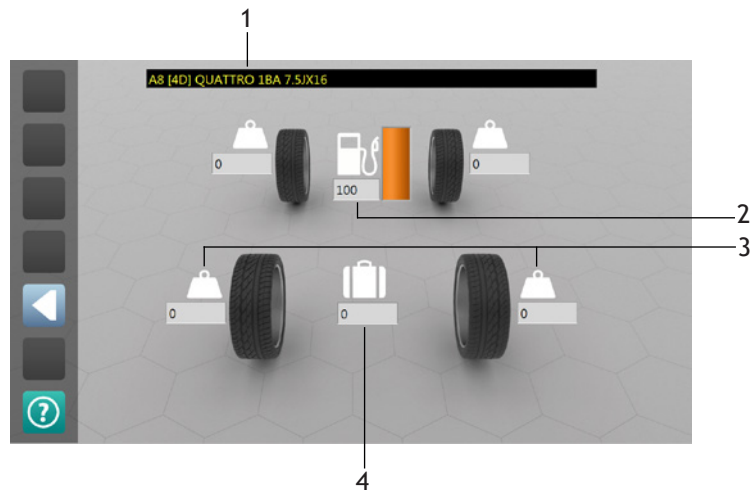

1. Vehicle
2. Percentage fuel in the tank
3. Loads to be positioned on the seats (kg)
4. Loads to be positioned in the luggage compartment (kg)

With reference to the figure check as far as possible the percentage fuel in the tank and if loads need to be positioned in the passenger and luggage compartments of the vehicle being measured.



: goes back to the Vehicle Specifications page

► 5.4 - Vehicle customisation

To access this page, press **Page Down** then **F4** from the Vehicle Specifications page

The Vehicle Customisation page allows adding vehicles to the vehicle database.

To do this, first select a vehicle on the Vehicle Selection page and then access this page to modify the model and the specifications. Of course, starting from a vehicle with similar specifications to the one to be added will simplify the job.

On this page you cannot change the vehicle manufacturer, which must therefore be selected first. You cannot add vehicles whose manufacturer is not already in the list of manufacturers on the Vehicle Selection page. There is however a generic manufacturer name called 'Extra' at the end of the list where these vehicles can be added. You cannot add ride height data nor adjustment help images.

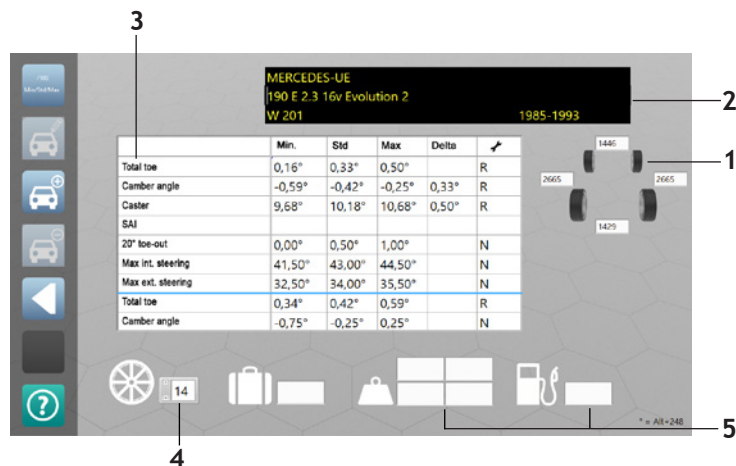

1. Wheelbases and tracks
2. Manufacturer, model, sub-model or technical name, year of registration of the vehicle (enter in the format 'aaaa - bbbb')
3. Angle values. The first 3 columns indicate: Minimum/standard/maximum or standard/upper tolerance/lower tolerance depending on what was selected with . The fourth column indicates the maximum difference between the right and left wheels. The monkey spanner indicates whether the angle is adjustable (R = adjustable; N = not adjustable)
4. Rim diameter (inches)
5. Weights and percentage fuel in the tank



: selects the unit of measure and the format of the data to be entered (for the angles)
 /60 = sexagesimal degrees (e.g. 1°55')
 /100 = centesimal degrees (e.g. 1.55°)
 min/std/max = data in the format minimum/standard/maximum/difference
 between right and left
 std/toll+/toll- = data in the format standard/upper tolerance/lower tolerance/difference
 between right and left



: saves the modifications (active only when modifying a customised vehicle created previously)



: creates a new customised vehicle saving the data entered



: deletes the customised vehicle (active only when modifying a customised vehicle created previously)



: goes back to the Vehicle Specifications page selected previously

► () 5.5 - Axle configuration

The Axle Configuration page allows configuring the axles of trucks, buses or semi-trailers

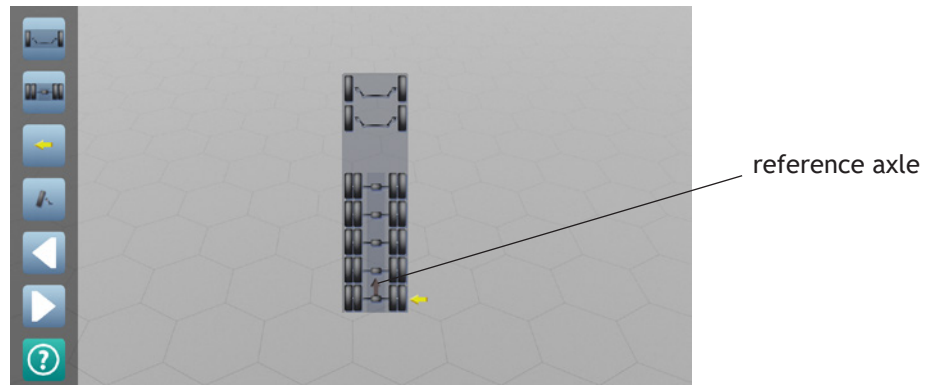





You can configure up to 7 axles of which 2 front ones as steering axles and 5 rear axles; the last rear axles can be configured as steering axles. On this page, select the reference axle, i.e. the rear axle used to establish, together with the first front axle, the direction of the truck symmetry axis. The reference axle is highlighted by the black vertical arrow in the middle of the axle; the first time you configure, place the rear measuring heads on it.

To select the reference axle, follow these criteria in order of priority:

1. Axle with possibility to adjust the thrust angle. In the case of a semi-trailer, if it is not possible to adjust the thrust angle for any axle, select the one where the tyres are less worn, as they will be better aligned with the fifth wheel pin compared to the other axles
2. Non-steering axle to prevent movement during the procedure
3. Axle as far as possible to the rear
4. Axle with possibility to adjust the distance between the wheels and the chassis

The software automatically sets the last rear non-steering axle as reference axle, since this is the most common case. To set a different axle, configure as steering axles the ones you do not want to use as reference axle. The only purpose of configuring the axles as steering and non-steering is to select the reference axle and it has no effect on the alignment procedure.

- | | |
|---|--|
|  | : adds/removes the second front steering axle |
|  | : adds/removes the rear axles |
|  | : moves the yellow arrow to select a rear axle |
|  | : configures the rear axle selected with the yellow arrow as steering/non-steering |

► () **5.6 - Fit and align the bar on the fifth wheel pin**

Only in the case of a semi-trailer, when you go to the next page you are asked to fit the front measuring heads on the fifth wheel pin adaptor.

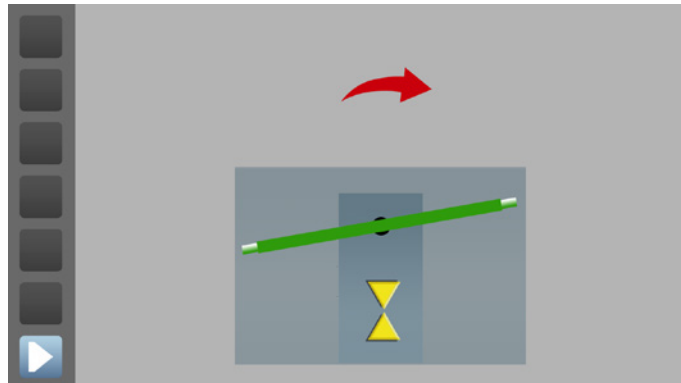

1



2



3



1. Position the bar on the pin and tighten the fastening knob
2. Fit and level the two front sensors on the bar
3. Straighten the bar aligning it following the on-screen instructions
4. Turn the adaptor as indicated until the word "STOP" appears.

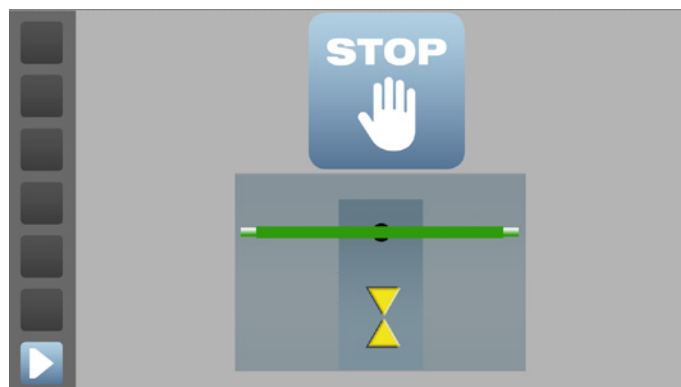

The runout phase allows correcting the wheel clamp mounting error.

This error is caused by imprecise positioning of the claws or by deformation of the rim or the wheel clamp and is difficult to avoid. Even though there are wheel clamps on the market that are claimed to be "without runout", there is actually no certainty that they sufficiently reduce the error.



It is advisable to always execute runout.

The runout phase consists of executing various measurements at various wheel rotation angles.

A comparison of these values allows the software to correct the wheel clamp mounting error.

There are four runout methods: in two of these the wheels are turned by pushing the vehicle on the ground, and in the other two by lifting the vehicle and turning the wheels by hand.





Each method is suitable for a certain condition; there is no best method for any one condition.

Method	Execution speed	Characteristics
180° on the ground	Fast	If the conditions to execute this method are given, it is the preferable one to use as it is fast and accurate. Since the vehicle is moved on the ground, the suspension settlement is not altered with respect to driving on the road and hence the measurements are more realistic than the methods where the vehicle is lifted. This method requires a flat ground surface without steps (for example, on sides of turn plates), little steering play and positioning of the steering lock to prevent the wheels from steering when the vehicle moves (the instrument will signal an error if this occurs). The surface must also be sufficiently long to allow the wheels to turn 180° and the vehicle must be light enough to be easily moved.
90° on the ground	Fast	Like the 180° runout on the ground, this method is fast and does not alter the suspension settlement. The requirements are identical, except that this method can also be used with shorter surfaces (car lifts) as the vehicle needs to be pushed only 90° to turn the wheels. An argument against this method is that it is slightly less accurate than the 180° method and you are more frequently asked to level the measuring heads because of the tighter tolerance. It would be a second choice instead of the 180° runout on the ground in case of short car lifts. It also requires that the ground or lift be level.
180° lifted	This method is not as fast as on the ground	If the conditions for the methods on the ground are not given, the methods with the vehicle lifted must be used, among which this one is preferable as it is slightly faster and more accurate than the 3x90° method. It is as accurate as the 180° runout on the ground but is slower because the vehicle must be lifted and the wheels turned manually one at a time. Since the vehicle is lifted the suspension settlement is altered with respect to driving on the road and hence the measurements are slightly less realistic than the methods on the ground. Some car makers specify that the methods with the vehicle lifted must not be used. To reduce this effect, the suspension must be settled after lowering the vehicle.
3x90° lifted	This method is not as fast as on the ground	Unlike the other three methods, it allows executing the runout of one wheel without having fitted the measuring heads on the others. This may come in handy because you can execute the runout immediately after fitting one measuring head without first having to fit the others. It is obligatory to use this method when the alignment sensors have been darkened by parts of the lift or when using the mode with 2 measuring heads.

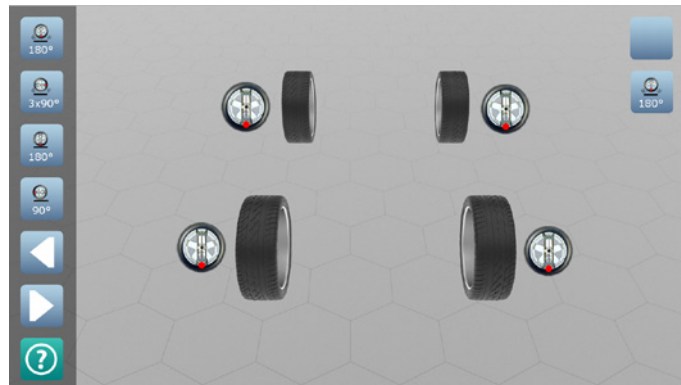
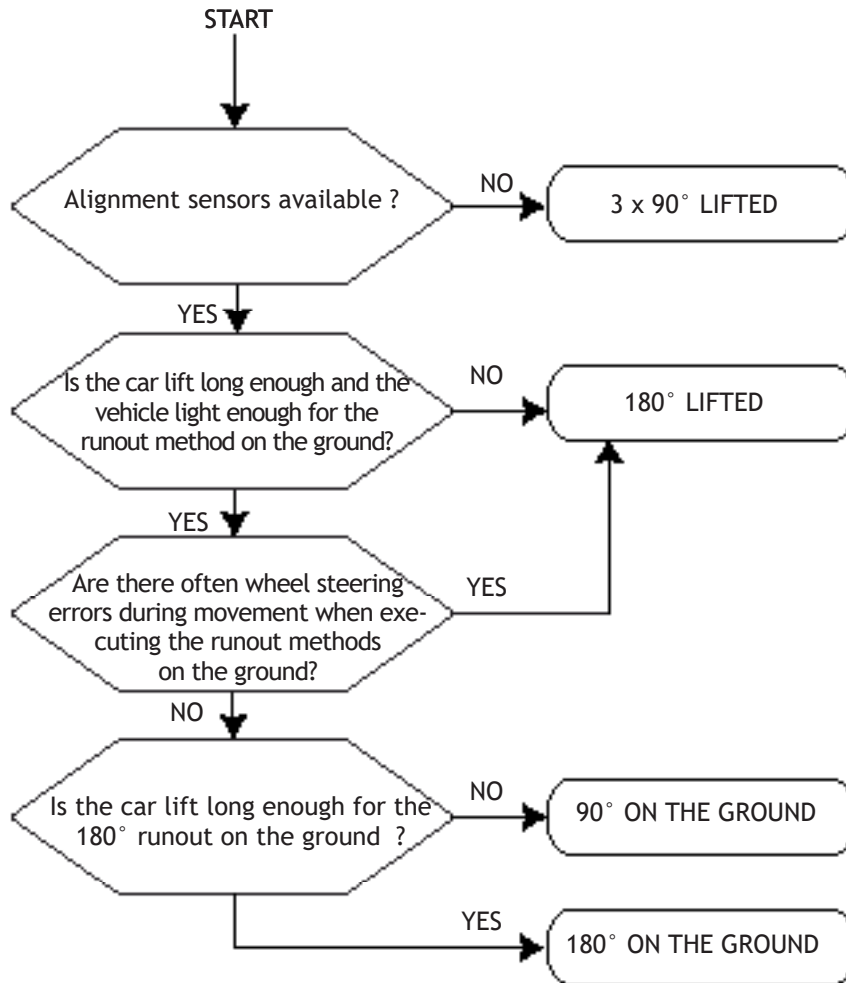

Scheme to follow to select the most suitable runout method:



- F1** : selects 180° runout lifted  [6.3](#)
- F2** : selects 3x90° runout lifted  [6.4](#)
- F3** : selects 180° runout on the ground  [6.2](#)
- F4** : selects 90° runout on the ground  [6.2](#)

► 6.1 - How to execute runout

Starting conditions:

- Position the vehicle with the front wheels on the turn plates, the steering wheel straight, the parking brake disengaged and the gear in neutral.
- Lock the turn plates and the rear slip plates
- Position wedges or other safety devices if necessary

1. Press **F1** (180° runout lifted), **F2** (3x90° runout lifted), **F3** (180° runout on the ground) or **F4** (90° runout on the ground) to select the desired runout method.
2. Mount the wheel clamps so that the handle is in the reference position, for example, the position suggested on the display (): mount the wheel clamps on the wheels indicated by the arrow
3. Fit the measuring heads without tightening the handles so that they are free to turn (for trucks only: fit the front measuring heads where indicated by the orange arrows and the rear measuring heads where indicated by the blue arrows)
4. Follow the instructions in the following paragraphs according to the runout method selected
5. Position the brake pedal lock
6. Press **F6**. An image will appear to remind you to position the brake pedal lock

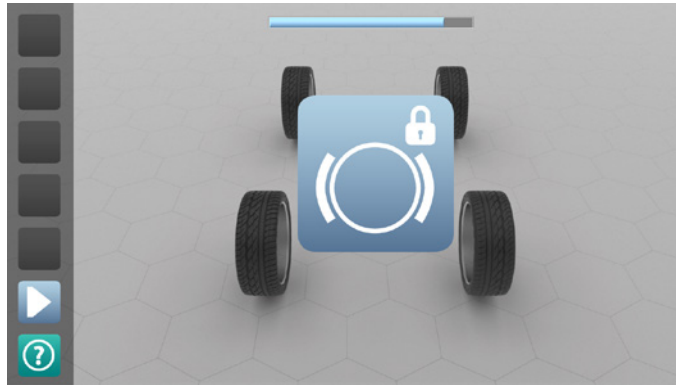

7. Again press **F6** or wait a few seconds before going to the next step



- The image of the wheel shows the wheel clamp handle as seen by the operator when looking at the wheel.

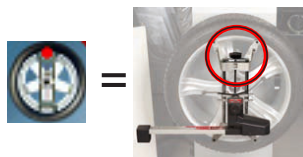

- If execution errors are signalled during the runout procedure, follow the on-screen instructions and, if requested, repeat the procedure. Otherwise, the result might be inaccurate.
- () : Fit the front measuring heads as indicated by the orange arrows and the rear measuring heads as indicated by the blue arrows.

Initially, you can also position the clamps handle differently from that suggested for example to facilitate securing any support arms, but than the direction and angle of rotation of the wheel must be respected.

► 6.2 - 180° or 90° runout on the ground

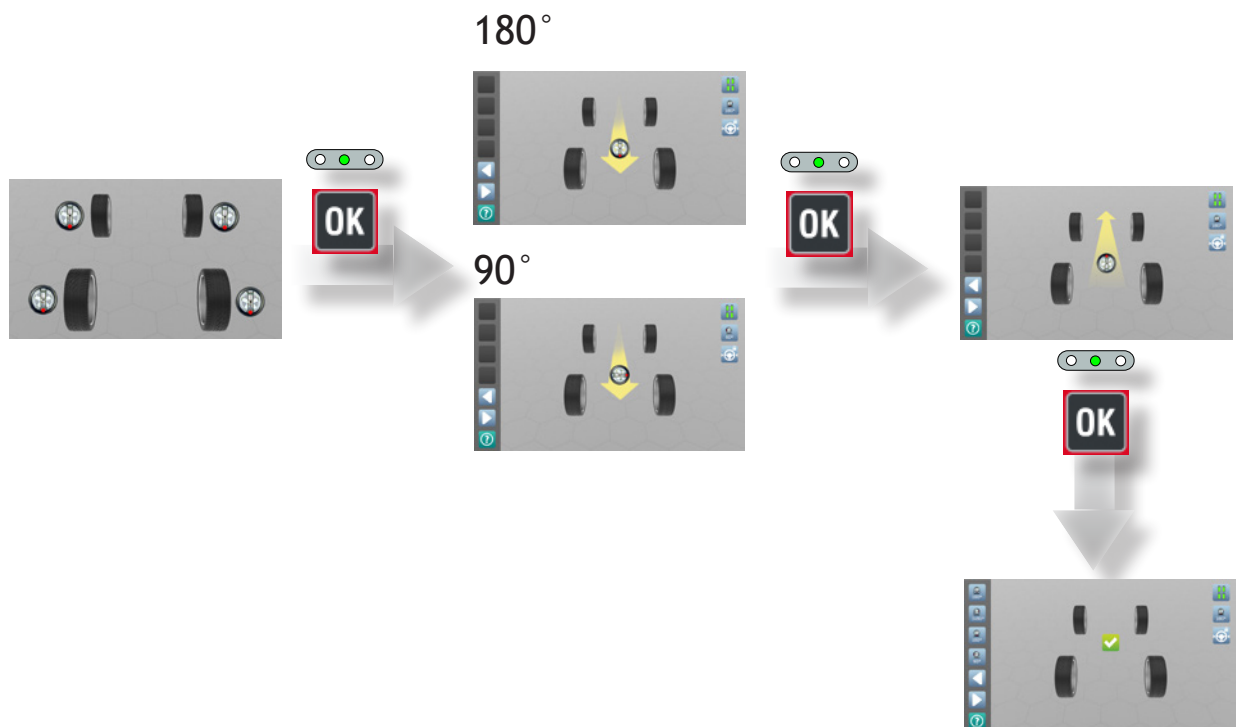

1. Align the steering wheel and position the steering lock
2. Level the measuring heads (green LED) and press **OK** on the keypad of any one of the measuring heads
3. Push the vehicle backwards until the wheels have turned half a turn (180°) or a quarter turn (90°)
4. Level the measuring heads and press **OK**
5. Push the vehicle forwards until it is back in the starting position
6. Level the measuring heads, lock the handles and press **OK**
7. Release the front turn plates and rear slip plates



- (90° method only): make sure that you turn the wheel with an angle within a smaller tolerance (+/-5°) than that required, otherwise the result might be inaccurate.
- Check that the front turn plates and the rear slip plates are locked, otherwise the result might be inaccurate.



In the case of runout on the ground, in HYBRID configuration and in CAR measuring mode, before moving the vehicle (step 3), position the rear sensors type TRUCK in the following position:



Fasten the rear sensors by tightening the pin locking knob; that way, you prevent the sensor from touching the horizontal plane during backward movement.

► 6.3 - 180° Runout lifted



1. Lift the vehicle so that the wheels are free to turn (you can also lift one wheel at a time)
2. Level all the measuring heads (green LED)
3. Turn a wheel to a reference position, for example, with the handle of the wheel clamp facing down, level the measuring head and press **OK**
4. Turn the same wheel by half a turn (180°) so that the knob of the wheel clamp faces up, level the measuring head and press **OK**
5. Repeat steps 3 and 4 for the other wheels
6. Release the front turn plates and the rear slip plates
7. Lower the vehicle
8. Settle the suspension by forcefully pushing on the vehicle so that it oscillates.



To minimise alteration of the suspension settlement with respect to driving on the road, caused by lifting the vehicle, it is important to release the front turn plates and the rear slip plates and settle the suspension.

► 6.4 - 3x90° Runout lifted

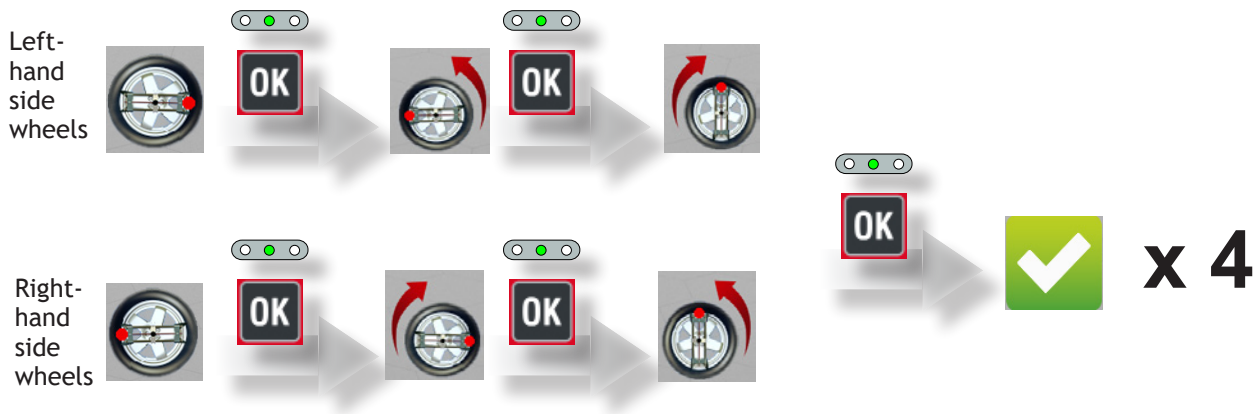

1. Lift the vehicle
2. Turn a wheel to a reference position, for example, with the handle of the wheel clamp facing the rear of the vehicle, level the measuring head and press **OK**
3. Turn the wheel by half a turn (180°) so that the handle of the wheel clamp faces the front of the vehicle, level the measuring head and press **OK**
4. Turn the wheel by a quarter turn (90°) in the backward movement direction of the vehicle so that the handle of the wheel clamp faces up, level the measuring head and press **OK**
5. Repeat steps 2, 3 and 4 for the other wheels
6. Release the front turn plates and the rear slip plates
7. Lower the vehicle
8. Settle the suspension by forcefully pushing on the vehicle so that it oscillates.



- Pay attention to the direction of rotation of the wheels. From the second to the third position the wheels must turn 90° as they would when the vehicle moves backward, i.e. the left wheels clockwise and the right wheels counterclockwise.



- To minimise alteration of the suspension settlement with respect to driving on the road, caused by lifting the vehicle, it is important to release the half turn plates and rear slip plates and settle the suspension.
- Make sure that you turn the wheel with an angle within a smaller tolerance (+/-5°) from that required, otherwise the result might be inaccurate.







7 - STEERING

The steering function allows measuring the characteristic steering angles: caster, SAI, TOOT. It consists of making several measurements with the wheels steered at different steering angles. You can select from three steering modes:

- FAST steering: recommended because it is fast to execute
- 10° steering: there is no technical reasons to use this method but it is available because many operators are accustomed to use it. It is advisable to execute fast steering instead as it is faster
- 20° steering: necessary to measure the TOOT and when imposed by the vehicle manufacturer

Press the key corresponding to the desired steering mode.



- | | | | |
|---|-----------------|---|---------------------|
|  | : 10° steering |  | 7.2 |
|  | : 20° steering |  | 7.2 |
|  | : Fast steering |  | 7.1 |

► 7.1 - FAST steering

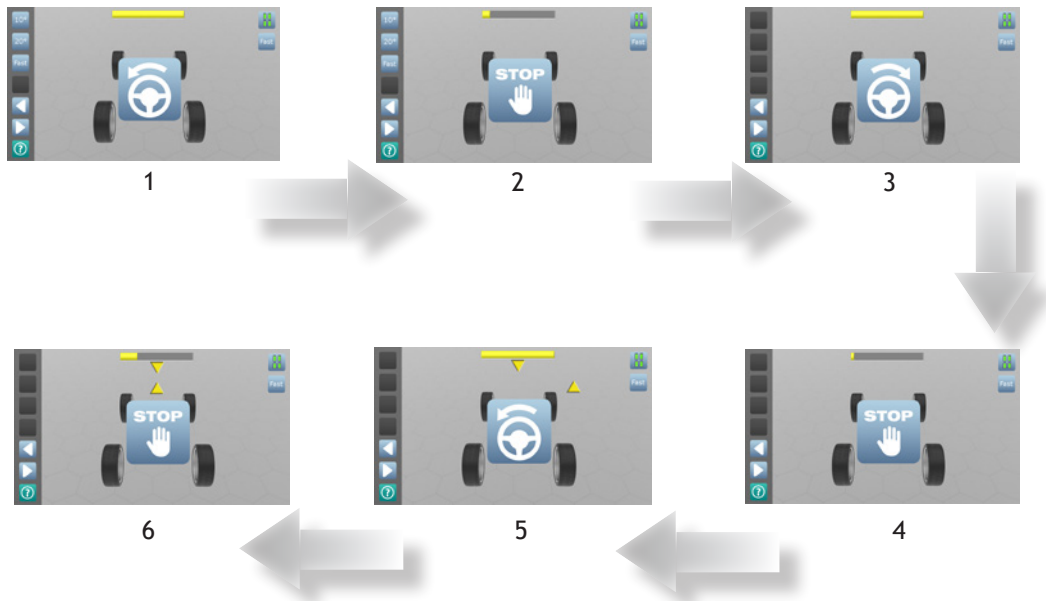

1. Steer to the left until the word "STOP" appears
2. Without moving the steering wheel, wait for "STOP" to disappear.
3. Steer to the right until the word "STOP" appears again
4. Without moving the steering wheel, wait until "STOP" disappears and a pair of yellow triangles appears
5. Steer to the left until the triangles are aligned. "STOP" appears again
6. Without moving the steering wheel, wait a few seconds. The vehicle Diagnostics page appears (👉 8)

► 7.2 - 10° or 20° steering

1. Steer in the direction indicated by the arrow until aligning the triangles; the word "STOP" appears
2. Without moving the steering wheel, wait for "STOP" to disappear.
3. ... 10. Repeat the above operations following the on-screen instructions. After the last operation the Diagnostics page automatically appears 👉 8

In 10° or 20° steering the number of positions to which you are required to steer is variable between 3 and 5. Steps 3,4 and 7,8 might not be required.

8 - DIAGNOSTICS

The Diagnostics page displays the measurements made on the vehicle before adjustment, next to the data-bank specifications. The measurements out-of-tolerance are displayed in red so that you can easily identify what to adjust.

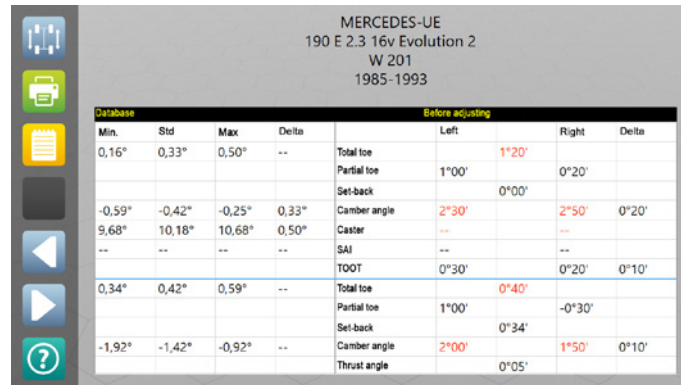

Database				Before adjusting			
Min.	Std	Max	Delta		Left	Right	Delta
0,16°	0,33°	0,50°	--	Total toe	1°20'	0°20'	
				Partial toe	1°00'	0°20'	
				Set-back	0°00'		
-0,59°	-0,42°	-0,25°	0,33°	Camber angle	2°30'	2°50'	0°20'
9,68°	10,18°	10,68°	0,50°	Caster	--	--	
--	--	--	--	SAI	--	--	
				TOOT	0°30'	0°20'	0°10'
0,34°	0,42°	0,59°	--	Total toe	0°40'		
				Partial toe	1°00'	-0°30'	
				Set-back	0°34'		
-1,92°	-1,42°	-0,92°	--	Camber angle	2°00'	1°50'	0°10'
				Thrust angle	0°05'		

F1

: displays the vehicle dimensions  [10.1](#)

F2

: prints the values measured

F3

: modifies the Customer Notes  [4.2](#)

9 - ADJUSTMENT

During adjustment the wheel angles are continuously measured and displayed so that the effect of the adjustments can immediately be seen.

The main angles are shown both in value

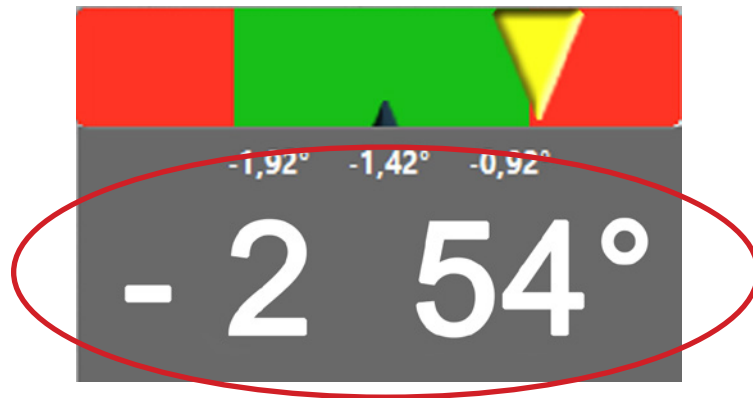

and in graphic form by an indicator on a green and red scale

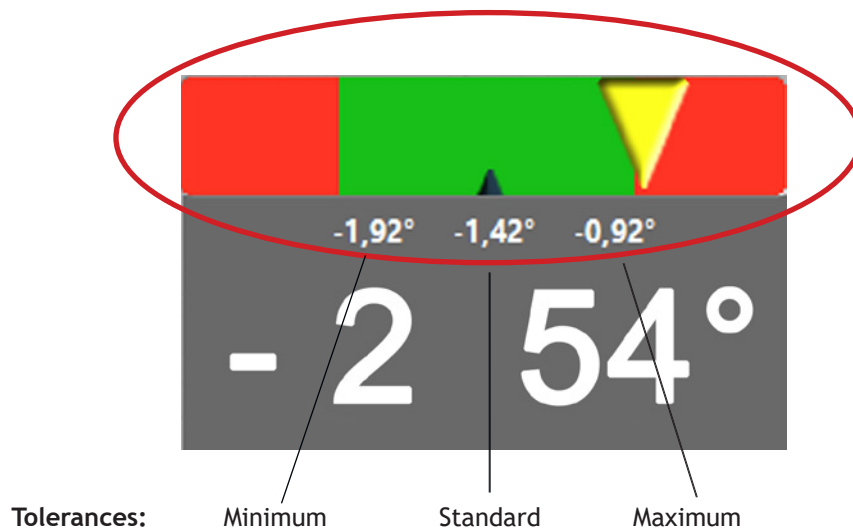





Adjust the angles until the indicator is in the green zone representing the angles in tolerance, while the red zone represents the angles out of tolerance.

To make it easier to see from a distance you can enlarge the green and red scale for the various angles by pressing the key **OK** on the measuring head keypad.

The following chapters explain the adjustment procedures and phases.

► 9.1 - Adjustment procedures

The adjustment procedure depends on the type of vehicle, the measuring mode and the manufacturer's specifications:

- **Adjustment procedure with two measuring heads**
 1. Front axle adjustment
-  **Normal car adjustment procedure**
 1. Rear axle adjustment
 2. Front axle adjustment
-  **VAS car adjustment procedure for vehicles equipped with Multilink suspension**
 1. (only in certain conditions established by the program) Front axle adjustment, except toe-in
 2. Rear axle adjustment
 3. (only in certain conditions established by the operator) Front toe-in adjustment with the vehicle resting on a support (toe-in curve)
 4. Front axle adjustment
-  **Truck adjustment procedure**
 1. Rear reference axle adjustment
 2. First front axle adjustment
 3. Adjustment proceeding towards the rear of the intermediate axles
 4. If necessary, adjustment of the last rear steering axle (only if present)
 5. If necessary, adjustment of the parallelism between the two front steering axles (only if present)
-  **Semi-trailer adjustment procedure**
 1. Adjusting the rear reference axle
 2. Adjusting the other rear axles
 3. Adjusting the last rear steering axle (only if present)

The software guides you through the adjustment procedure, one by one showing the phases to carry out. The possible phases are described in the following chapters.

► 9.2 - Adjusting a rear axle

The Rear Adjustment page displays the measurements and relative tolerances of the camber and partial toe-in of both wheels. It displays also the thrust angle and, in small font, the total toe-in, the difference between the left and right camber and its maximum permitted value.

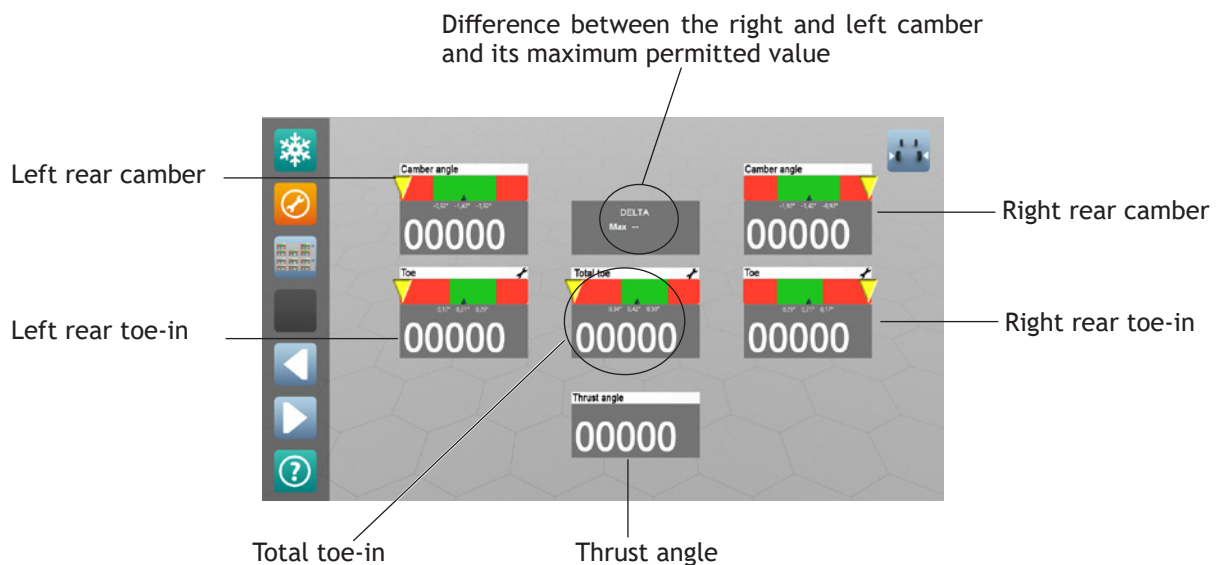



Adjust in order the wheel camber and toe-in until the indicator is in the green zone. The thrust angle is cancelled when the toe-in of the wheels is the same.



For optimal adjustment, first adjust the camber and then the toe-in

If it is difficult to access the adjustment points, you can use the "freezing" procedure to adjust with the vehicle lifted.

To make it easier to identify the adjustment points, use the adjustment help images.

-  : freezing  [9.7](#)
-  : displays the adjustment help images  [5.1](#)
-  : changes the display from partial toe-in to total toe-in or shows the front and rear axle simultaneously  [9.3](#)

► 9.3 - Adjusting a front axle

Before adjustment of a front axle the following may appear:



1. Level the steering wheel and position the steering lock
2. Press  or wait a few seconds for the Front Adjustment page to appear



Correctly level the steering wheel and firmly position the steering lock; this is required to prevent the steering wheel from going askew.

The Front Adjustment page displays the measurements and the relative tolerances of the caster, camber and partial and total toe-in of both wheels in large font. As alternative to the partial toe-in angles you can view the total toe-in and the steering angle.

Difference between the right and left values and the maximum permitted value

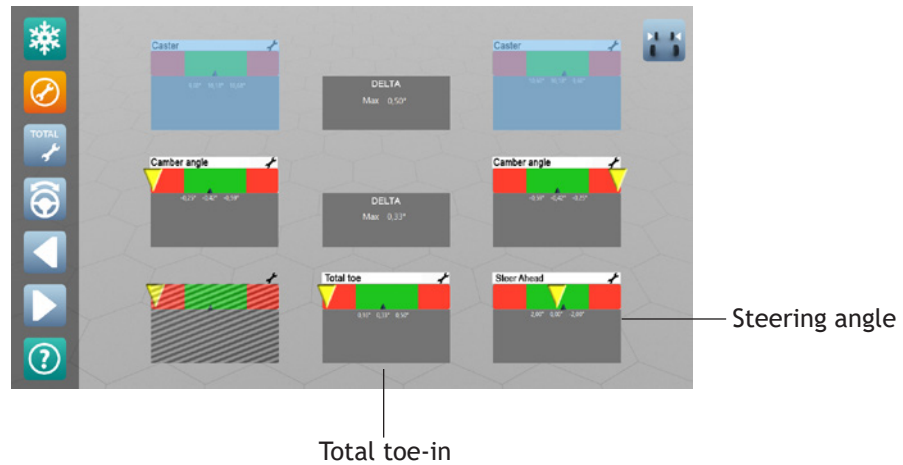
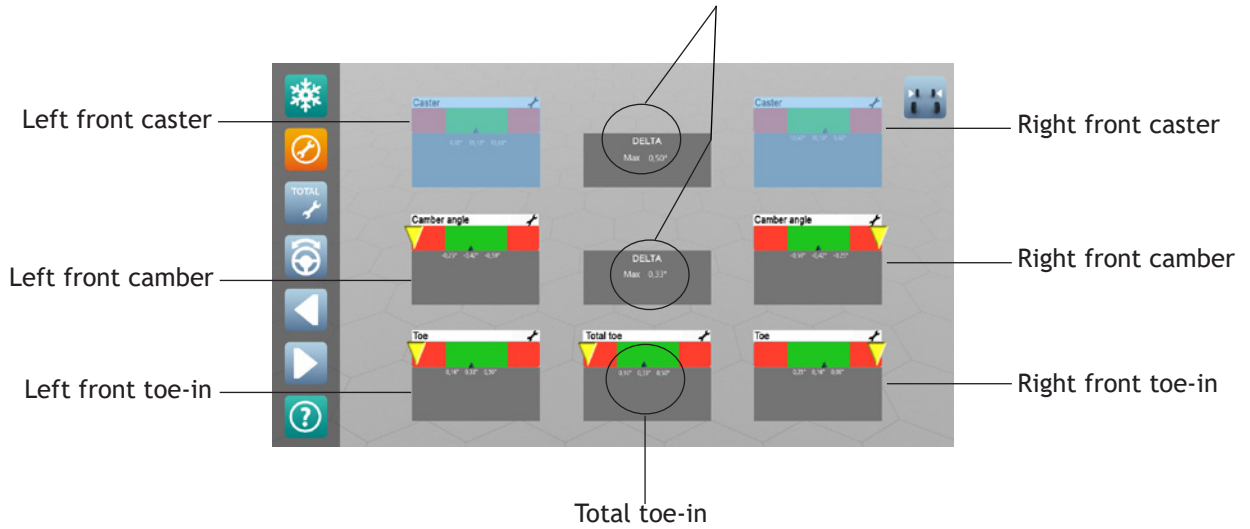

The differences between the right and left camber and caster and the relative tolerances are also displayed.

The display of the partial toe-in allows adjusting the toe-in of vehicles equipped with a suspension system that allows adjusting the two wheels independently; this is true for most cars. Vice versa, the display of the total toe-in and the steering angle allows adjusting vehicles equipped with a total toe-in adjustment bar, which does not allow adjusting the two wheels independently; this is true for all trucks and some off-road vehicles.

Adjust in order the caster, camber and toe-in of the wheels until the indicator is in the green zone



For optimal adjustment follow the adjustment order: caster, camber, toe-in.



From the Front Adjustment page you can go to the Steering page.

In the case of the truck procedure, if you wish to execute steering, you need to access it from this page. In the case of the car procedure, it is advisable to repeat steering as a check if the caster is adjusted, since the caster measurement displayed on this page is necessarily an estimate.

() Adjustment sequence for the truck procedure:

1. Centre the steering box by turning the steering wheel
2. If necessary, straighten the steering wheel by acting on the adjuster between the steering box and the steering wheel without moving the steering box
3. Lock the steering wheel with the steering lock
4. Adjust underneath the vehicle to bring the total toe-in into tolerance and the steering angle to null

To make it easier to identify the adjustment points, use the adjustment help images.

 : freezing  [9.7](#)

 : displays the adjustment help images  [5.1](#)

 : switches the display from partial toe-in to total toe-in or shows the front and rear axle simultaneously

 : goes back to the steering procedure  [Z](#)

► () **9.4 - Adjusting a rear axle**

Before the Rear Adjustment page, the Chassis Distance page appears to remind you to adjust the axle with respect to the chassis.

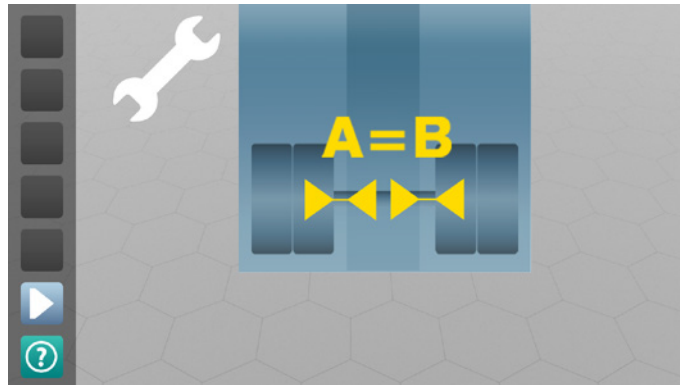

1. Check with a rule and if necessary adjust the distance between the wheels and the chassis so that it is the same for the right and left wheels
2. Press  or wait a few seconds for the Rear Adjustment page to appear

Even if the distance between the wheels and the chassis is not adjusted, the wheels will be aligned with each other at the end of the alignment procedure. Nonetheless, if the distances between the wheels and the chassis differ greatly for the reference axle, at the end of the procedure the wheels might not be aligned with respect to the chassis and the truck will thus move in "dog step" with the consequent aerodynamic problem.



It is advisable to adjust the distance between the wheels and the chassis at least for the rear reference axle.

The Rear Adjustment page is similar to that described in [paragraph 9.2](#).



The meaning of the value displayed in the box depends on the axle being adjusted

- Reference axle: thrust angle (angle between the axle direction and the truck symmetry)
- Other rear non-steering axles: scrub angle (angle between the axle direction and the thrust line).
- Rear steering axles: disabled

► () **9.5 - Adjust the parallelism between the two front steering axles**

In the case of trucks equipped with two front steering axles, at the end of the adjustment procedure you are asked to position the four measuring heads on the two front steering axles to adjust the parallelism between the direction of the first and the second front steering axle.

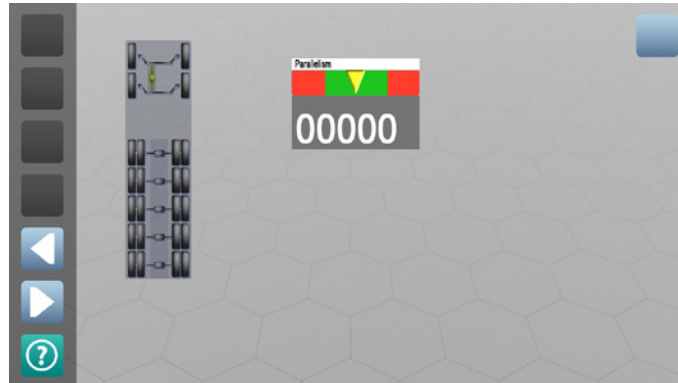

Adjust the parallelism of the two steering axles taking care not to excessively steer the wheels; in this case a warning will be displayed.

► () **9.6 - Adjusting the front toe-in with the vehicle resting on a support (toe-in curve -VAS procedure)**

For vehicles for which the VAS procedure is required, when exiting the Rear Adjustment page, a message is displayed asking you to do some checks on the vehicle.



1. Check the vehicle conditions

- If they do not fall within one of the cases contemplated in the message, press **F5** to go directly to the Front Adjustment page
- otherwise press **F6** to continue. The following appears:

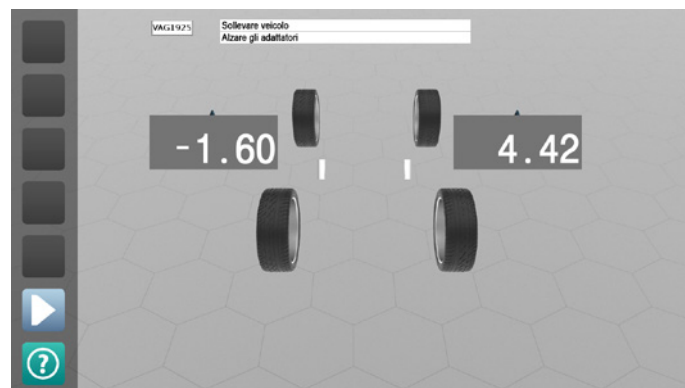

2. Lift the vehicle and position the VAS tool underneath the front axle
3. Move the adapters into "raised" position and position the vehicle on them lowering it slowly
4. Press **F6**. The following appears:

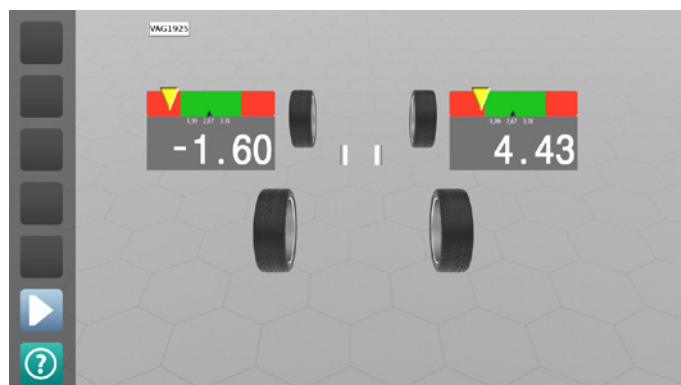

5. Adjust the toe-in by acting on the upper head

6. Press  and the following appears:

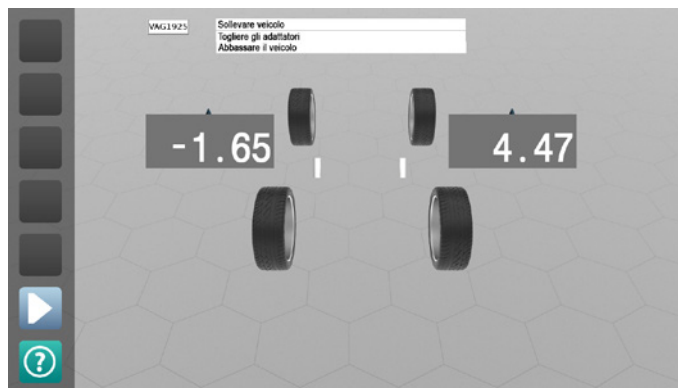

7. Lift the vehicle, remove the VAS tool, lower the vehicle and settle the suspension

8. Press  to go to the Front Adjustment page.

► **9.7 - Adjusting with the wheels raised or steered (freezing)**

If it is difficult to access the adjustment points, for example, because the vehicle is on the ground or the adjustment point is hidden by parts of the suspension, you can use the "freezing" procedure to adjust with the vehicle lifted or the wheels steered.



Freezing is particularly useful in the case of a 2-column car lift

The Freezing procedure consists of storing ("freezing") the measurements with the vehicle lowered and the wheels straight in order to keep them unaltered also after the vehicle has been lifted or the wheels steered. Thus you can adjust the angles to within the specified tolerances as if the vehicle were still lowered with the wheels straight.



This procedure can be activated on both the Front Adjustment and the Rear Adjustment page.

Starting from an adjustment page:

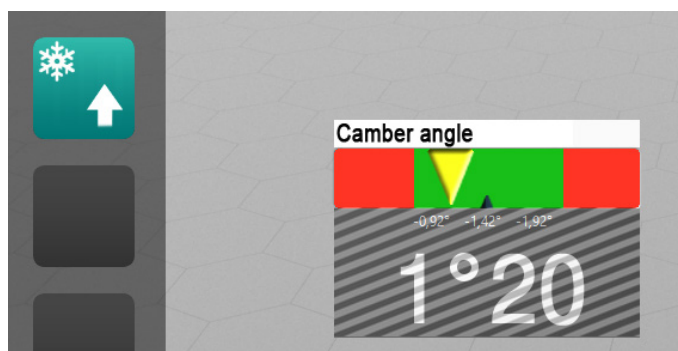
1. Press   to freeze the measurements. The graphics shows that the measurements have been frozen





2. Lift the vehicle or steer the wheels



3. Press   to unfreeze the measurements

4. Adjust the angles

5. If you are on the Rear Adjustment page and wish to do so, press  to go to the Front Adjustment page and adjust the front angles.

6. Press   to again freeze the measurements

7. Lower the vehicle or straighten the wheels

8. Press   to again unfreeze the measurements

If you go from the Rear Adjustment page to the Front Adjustment page with the vehicle lifted, for easier operation it is suggested to level the steering wheel and position the steering lock before lifting the vehicle.

► 9.8 - Adjustment in case of interruption of the infrared rays

If you are unable to adjust without standing between the optical sensors, and the warning that the rays are interrupted appears, you can disable the message in order to adjust the camber.

From the page where the “rays interrupted” warning is shown:



 : to disable the “rays interrupted” warning

10 - SUMMARY

Once you have completed the adjustments, the Summary page appears summarising the measurements before and after adjustment. From this page you can save or print the measurements; modify the customer informations; view the vehicle dimensions and enter the maximum steering measurements















Before adjusting				After adjusting			
Left	Right	Delta		Left	Right	Delta	
1°00	1°20	0°20	Total toe	1°00	1°20	0°20	
	0°00		Partial toe		0°00		
2°30	2°50	0°20	Set-back	2°30	2°50	0°20	
--	--	--	Camber angle	--	--	--	
--	--	--	Caster	--	--	--	
0°90	0°80	0°10	SAI	0°90	0°80	0°10	
			TOOT				
	0°70		Total toe		0°70		
1°00	-0°30		Partial toe	1°00	-0°30		
	0°34		Set-back		0°34		
2°00	1°90	0°100	Camber angle	2°00	1°90	0°100	
	0°05		Thrust angle		0°05		

Before adjusting				After adjusting			
Left	Right	Delta		Left	Right	Delta	
1°00	1°20	0°20	Total toe	1°00	1°20	0°20	
	0°00		Partial toe		0°00		
2°30	2°50	0°20	Set-back	2°30	2°50	0°20	
--	--	--	Camber angle	--	--	--	
--	--	--	Caster	--	--	--	
0°90	0°80	0°10	SAI	0°90	0°80	0°10	
			TOOT				
	0°70		Total toe		0°70		
1°00	-0°30		Partial toe	1°00	-0°30		
	0°34		Set-back		0°34		
2°00	1°90	0°100	Camber angle	2°00	1°90	0°100	
	0°05		Scrub angle		0°05		

Axes whose measurements are displayed

- F1** : () adding notes relating to the customer  [4.2](#)
- () displays the measurements of the other axles
- F2** : prints the results
- F3** : saves the results. They can be retrieved in the future from the Customer Databank page  [3.3](#)
- F4** : menu
 - F1** : runout  [6](#)
 - F2** : steering  [7](#)
 - F3** : customer informations  [4.2](#)
 - F4** : maximum steering  [10.2](#)
 - F5** : () vehicle dimensions  [10.1](#)

► () **10.1 - Vehicle dimensions**

To access this page from the Summary page press **F4** and then **F5**.

The vehicle dimensions are useful to check the symmetry and identify any damage to the suspension system or the chassis.

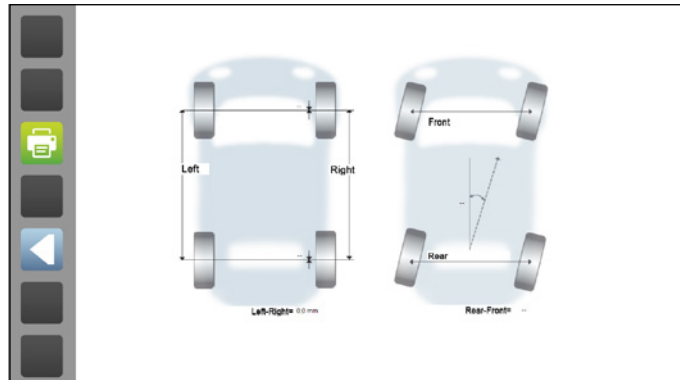

The page displays the thrust angles, axle deviation (set-back), wheelbase and track difference in value and in schematic form. These angles are displayed in degrees or in millimetres or inches according to the data available in the databank.



: printing

► **10.2 - Maximum steering**

To access this page, from the Summary page press **F4** and then **F4**.

Maximum steering allows checking correct centring of the steering box and all the directional devices connected to it. The maximum steering values are not measured by the instrument but must be physically read on the graduated scale on the mechanical turn plates.

On this page you can enter the maximum internal and external steering values for the right and left wheels so that they are shown in the printout

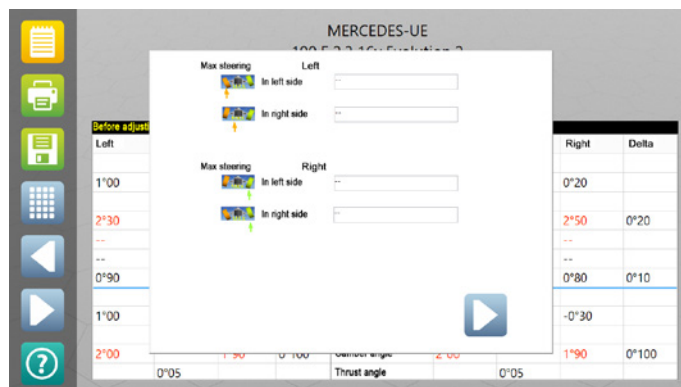

: selects the box where to enter the respective steering value



... **9** : enters the steering value read



: saves and exits

11 - WHEEL ALIGNMENT AND MEASURING HEAD LEVELLING

In some phases of the alignment procedure, the Alignment and Levelling page may appear asking you to align the wheels and level the measuring heads.

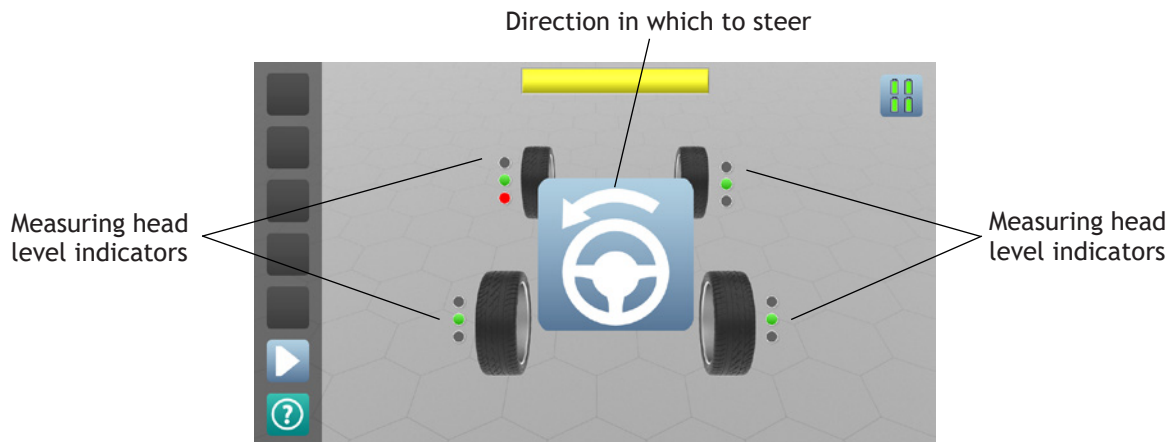

1. Steer in the direction indicated by the arrow until the word "STOP" appears to align the wheels
2. Level the measuring heads of which the level indicators are shown on the display until they are in horizontal position (only the central green LED is on)
3. Wait a few seconds to automatically go to the next step

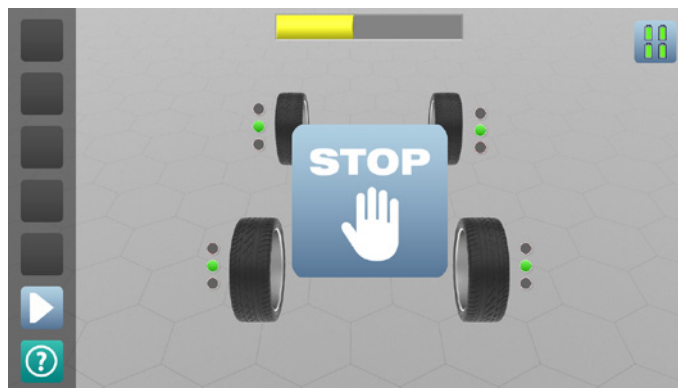

For some vehicles, especially if fitted with a spoiler, the vehicle body may get in the way of the optical toe-in sensor beam preventing measurement.

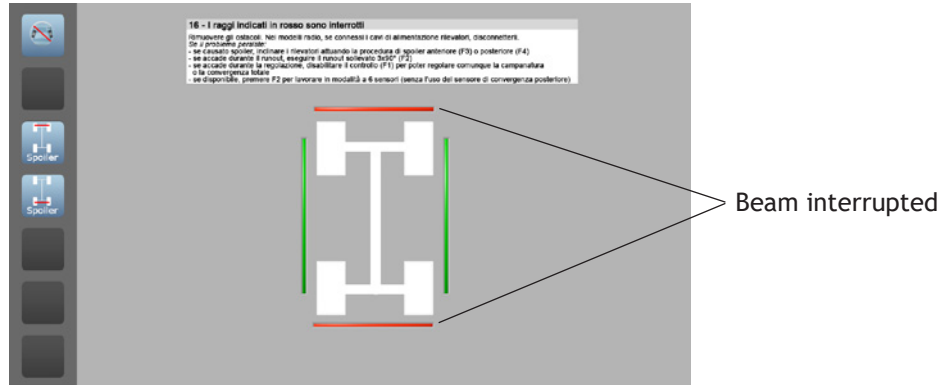

In this case, a message appears to warn you that the toe-in sensor beam has been interrupted. In order to, in any case, make the measurement, you can start the Spoiler procedure, which consists of inclining the measuring heads that are unable to measure until the optical sensors can see each other. You can activate this procedure for the front or the rear measuring heads or both.

	: spoiler procedure for front axle
	: spoiler procedure for rear axle

1. Press or to activate the desired Spoiler procedure (in this example: front) The following appears:

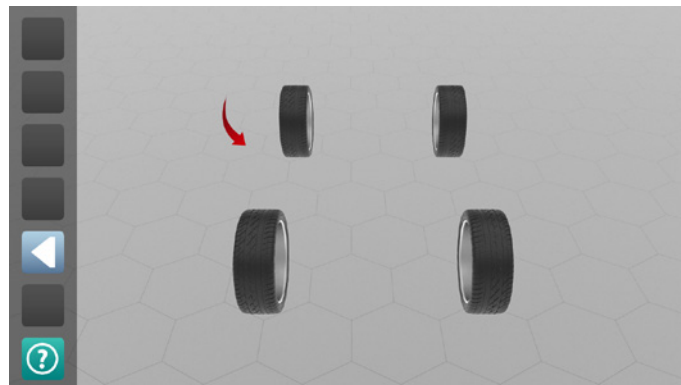

2. Release the handle and incline the measuring head indicated by the arrow (in this example: left front) until the optical sensor can see the other side of the vehicle, then lock the handle

3. Press **OK** on the measuring head keypad. The level indicator now shows only the central green LED on, as if the measuring head were horizontal. The following appears:

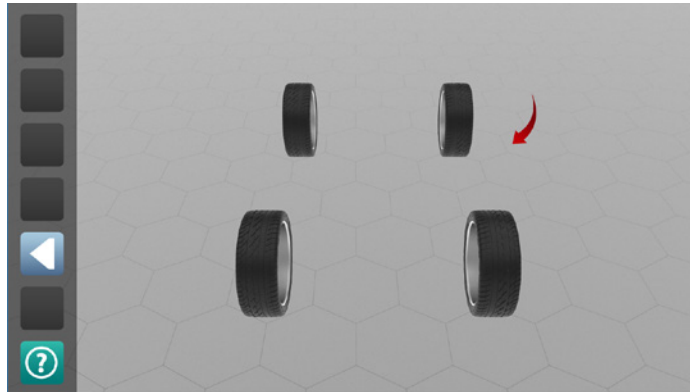

4. Release the handle and incline the measuring head on the other side of the vehicle (right front) until only the central green LED is shown on then lock the handle. Both the measuring heads are now at the same level and the optical sensors can see each other underneath the vehicle.
5. Press **OK** on the measuring head keypad indicated by the arrow (right front). The following appears:

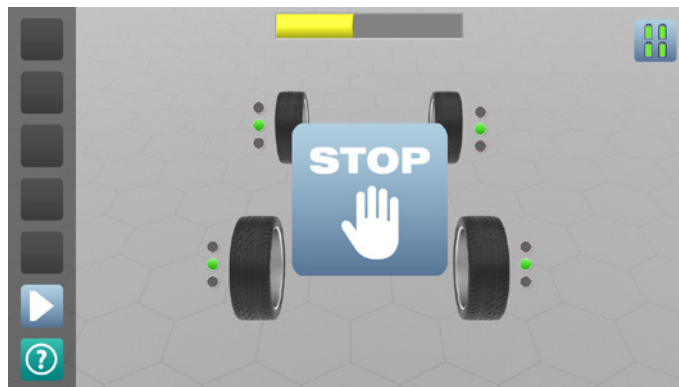

6. Wait a few seconds to go back to the Measurement page.

► 13.1 - Cleaning

- Clean the display with a dry, soft and antistatic cloth; if it is particularly dirty, clean it with a moist cloth and then dry.
- Dust the PC keyboard with a soft brush. When not in use, it is advisable to cover the system to protect it against dust.
- Clean the optical units of the measuring heads using a moist cloth; do not use solvents.
- Cleaning, cartridge replacement and other operations relating to printer maintenance are described in the printer manual. Carefully read it before performing any maintenance operation on the printer.

► 13.2 - How to activate the databank and the software

When to perform it	<ul style="list-style-type: none"> • After updating the databank for which you do not have access rights (on the home page the activation window appears and the message "Invalid DB code"). • You wish to activate sections of the software not activated before (e.g. Truck program).
Prerequisites	Databank and software update



To activate the databank and software you need to obtain the activation code from our customer service. You might not get an immediate response, therefore ask for the activation code well in advance.

1. Display the databank and software Activation window

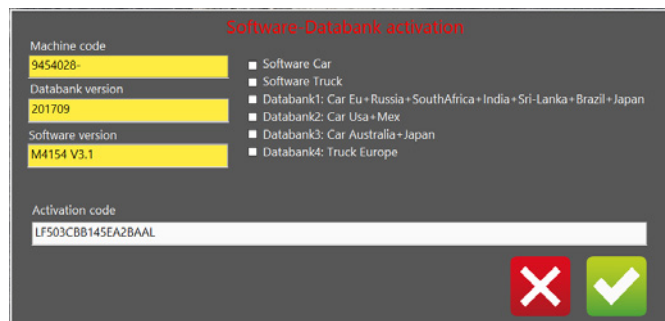

- The window automatically appears upon starting. Alternatively, starting from the Home page:
 - a. Press **F3** and then **F1** to access the Settings page
 - b. Press **F2** to access the Activation window

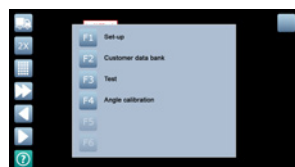

- Communicate to our customer service the "Machine serial number", the "Databank version", the "Software version" and the sections of the software (car, truck or both) and the groups of databanks for which you wish to obtain the activation code.

Example:

Databank version: 200801All

Machine serial number: 1234-003F

Software: Car + Truck

Databank: 1 + 4 (Europe car and truck)

- Enter the activation code received from our customer service
 - Press [TAB] until you get to the "Activation code" box
 - Enter the activation code making sure that you use capital letters

- Press the key  to confirm.

- If a red ball appears,

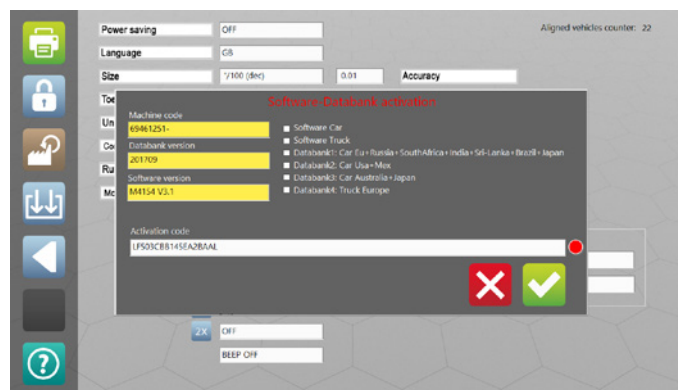

- the code is invalid; check the code. If you do not have a valid code, press  to exit the Activation window.
- If the code is valid, the Activation window will automatically close.

14 - TROUBLESHOOTING

► 14.1 - Malfunctions

The computer does not turn on

No power supply	Check the mains socket and the connections Press the computer power-on button
-----------------	--

Display off	Turn on the display (button on display)
-------------	---

The measuring head does not turn on or turns off unexpectedly

Batteries flat	Charge the batteries
----------------	----------------------

Battery recharging does not start

No power supply	Check the mains socket and the connections Press the battery recharge button  1.2
-----------------	---

The battery life is too short

Low ambient temperature	Normal phenomenon
-------------------------	-------------------

Recharging not complete	Recharge the batteries for at least 5 hours
-------------------------	---

The battery has come to the end of its lifetime	Replace the battery
---	---------------------

This screen appears



No communication	Check that all the measuring heads are on
------------------	---

"Invalid DB Code" message or vehicle data not displayed

Databank not activated	Activate the databank  13.2
------------------------	---

The software window is not displayed centred on the screen

Incorrect setting	Untick the option 'Always in the foreground' on the Windows application bar
-------------------	---

The keyboard does not work

Keyboard disconnected from computer Check that the keyboard is connected to the computer

Keyboard language incorrect Set the keyboard language
 *Windows manual*

The mouse does not work

Mouse disconnected from the computer Check that the mouse is connected to the computer

The printer does not work

The printer is off Turn on the printer by pressing the button on the printer

Printer disconnected from the computer Check the power and data connections between the printer and the computer

Printer fault  *Printer manual*

Ink run out Replace the ink cartridge  *Printer manual*

Printer model incorrect Set the correct printer model
 *Windows manual*

► 14.2 - Alignment problems

The steering wheel remains askew

Runout compensation not executed	<ul style="list-style-type: none"> • Repeat the measurement executing runout compensation • If you do not intend to execute runout compensation, minimise the runout error by using 3-point wheel clamps or grippers designed to minimise the runout error of 4-point wheel clamps
Runout compensation executed inaccurately	<p>Repeat the measurement and during runout pay attention to:</p> <ul style="list-style-type: none"> • Follow the instructions which may appear on the screen • In the case of runout on the ground, fit the steering lock • Turn the wheels with a small tolerance with respect to the required angles; especially for the 90° runout • Release the turn plates and the rear slip plates and settle the suspension after lowering the vehicle in case of runout with the vehicle lifted
Alignment executed in the mode with 2 measuring heads	Repeat the measurement in the mode with 4 measuring heads
Steering wheel not aligned when requested	Repeat the measurement aligning the steering wheel when requested
Approximate adjustment of the alignment angles	Repeat the measurement adjusting the angles more accurately
Excessive play in the suspension	Replace the mechanical parts with play

Toe-in or camber not plausible

Runout compensation not executed	Repeat the measurement executing runout compensation
Greatly different tyre pressures	Equalize the tyre pressures

Toe-in not plausible

<p><i>Only for side-by-side car lifts</i></p> <p>CCD sensor disturbed by the LED of the measuring head on the adjacent car lift</p>	Place a panel between the car lifts
CCD sensor disturbed by a reflection on the reflecting surface	Identify and darken the reflecting surfaces

The camber tends to always have the same sign

Car lift or floor not sufficiently levelled	<p>Level the car lift according to the following tolerances:</p> <ul style="list-style-type: none"> - Maximum difference in height between two wheels along the wheelbase or track of the vehicle: 1 mm - Maximum difference in height between two wheels along the diagonal of the vehicle: 1.5 mm
---	---

This screen appears



Beams interrupted by the operator getting in the way

Free the visual range of the infrared beams

Lateral rays interrupted by interposition of an irremovable obstacle

Activate the procedure that allows you to adjust when the rays are interrupted 👉 9.8
Execute 3x90 runout 👉 6.4

Front or rear beams interrupted by the vehicle getting in the way

Activate the Spoiler procedure 👉 12

CCD sensor blinded by the sun

Put the CCD sensor in the shade

On the road the vehicle "pulls" to one side

Tyres differently worn

Replace the tyres or try and fit the rear ones at the front and vice versa

If the "pulling" direction varies accelerating or decelerating
Play in the suspension

Replace the parts with play

Humpbacked road

This is not a defect

Right caster or camber greatly different from the left

Equalize the caster or the camber

Negative caster

Make the caster positive

15 - STORING AND SCRAPPING

▶ 15.1 - Storing

In the event of long-term storage, disconnect the power supply and protect any parts which may be damaged by excessive accumulation of dust, such as the printer and the display. Grease parts which may be damaged if allowed to dry out.

▶ 15.2 - Scrapping

If the machine is no longer to be used, it must be made inoperational. Render harmless any parts which may constitute a source of danger. Assess the machine classification according to the degree of disposal. Take scrap metal to specific waste collection centres. If deemed special waste, dismantle and separate into homogeneous groups and dispose of in accordance with the laws in force.



The batteries must be collected separately at the end of their life cycle (in countries where differentiated waste collection is applied)



16 - TESTING THE MEASURING HEADS BY FITTING THEM ON THE VEHICLE

► 16.1 - Measurement I - Toe-in and camber in driving direction

Position the vehicle in the measuring position but not above the turn plates and the sliding plates. Engage the brake pedal lock. Fasten the quick-fastening units. Fit the measuring heads and align them horizontally using a spirit level. Measure the total toe-in on the front and rear wheels based on the measurement sheet (rows 1-2) and note down the values in column 1. Measure the camber on the front and rear wheels based on the measurement sheet (rows 3-6) and note down the values in column 1.

► 16.2 - Measurement II - Toe-in and camber in reverse driving direction

Exchange the front left measuring head with the rear right measuring head, and the front right measuring head with the rear left measuring head, then horizontally align all the measuring heads using a spirit level taking care not to move the vehicle. Measure the total toe-in on the front and rear wheels based on the measurement sheet (rows 1-2) and note down the values in column 2. Measure the camber on the front and rear wheels based on the measurement sheet (rows 3-6) and note down the values in column 2.

► 16.3 - Evaluation of the values measured during the measuring head test

Column	Row	Operation
1 and 2	1-2	If there are different signs in the same row, subtract the smaller from the larger value and note down the result in column 3. Note down the larger value sign in column 3 If the signs are the same, add the measurement values and note down the result with the sign in column 3
	3-6	If there are different signs in the same row, add the values and note down the results in column 3. Note down the sign of column 1 in column 3. If the signs are the same, subtract the smaller from the larger value and note down the result in column 3. If the larger value is in column 1, the sign is accepted; if the larger value is in column 2, the sign is changed

Values to compare:

3	1 with 2	If the signs are different, add the measurement values and note down the result in column 4 If the signs are the same, subtract the smaller from the larger value and note down the result in column 4
	3 with 6 4 with 5	If the signs are different, subtract the smaller from the larger value and note down the result in column 4 If the signs are the same, add the measurement values and note down the results in column 4
4		The values in column 4 must be smaller than 3'. If they are larger, it means that errors occurred during the measurement (e.g. the vehicle or the quick-fastening units moved) and the measurement must be repeated
3		The values in column 3 must be smaller than 15'. If the differences are greater, the device must be recalibrated (Technical Service)

MEASUREMENT SHEET FOR MEASURING HEAD TEST

Example:

Company:	Device no.:
	Year of construction:
	Measurement made:
	Date:

R O W	MEASUREMENT I	COLUMN I		MEASUREMENT II	COLUMN II		COLUMN III		COLUMN IV
	IN DRIVING DIRECTION	S i g n	Meas- ure- ment value	IN REVERSE DRIVING DIRECTION	S i g n	Meas- ure- ment value	S i g n	Difference	
	TOE-IN			TOE-IN					
1	Total front toe-in	-	3'	Total rear toe-in	+	5'	+	2'	+1'
2	Total rear toe-in	+	30'	Total front toe-in	-	27'	+	3'	
	CAMBER			CAMBER					
3	Front left camber	-	41'	Rear right camber	-	40'	-	1'	-1' 0
4	Front right camber	-	36'	Rear left camber	-	33'	-	3'	
5	Rear left camber	-	1° 25'	Front right camber	-	1° 27'	+	2'	
6	Rear right camber	-	1° 44'	Front left camber	-	1° 45'	+	1'	

