

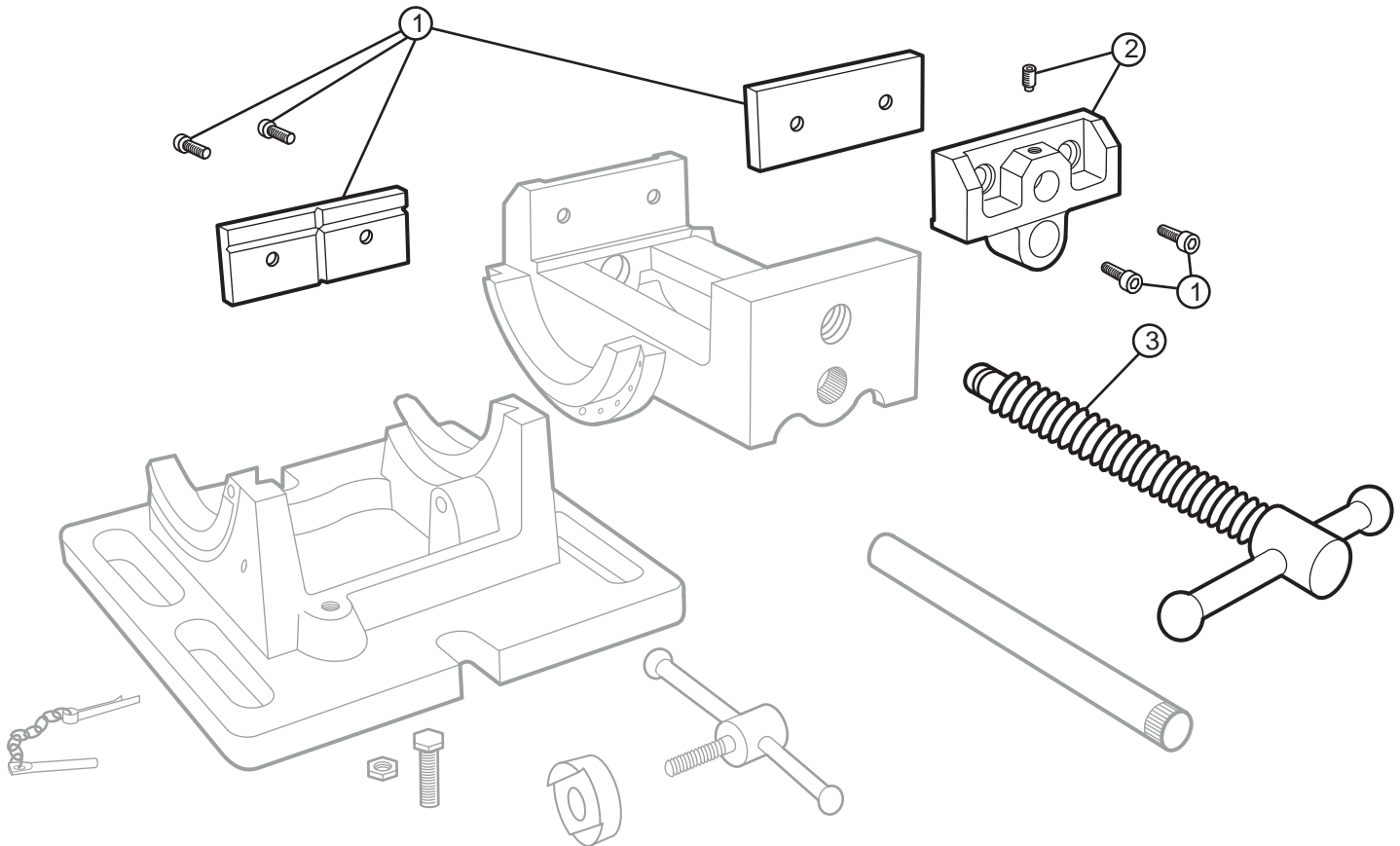

3" Cradle Style Angle Drill Press Vise - Parts Diagram

3" Jaw Width, 3" Jaw Opening, 1-1/8" Jaw Depth

Stock #: 11753 Model #: CR3



#	Part	Description
1	11753-01	Jaw Insert Assembly (4 screws)
2	11753-02	Movable Jaw & Screw
3	11753-03	Spindle & Handle Assembly

⚠ WARNING: This product can expose you to chemicals including lead which is known to the State of California to cause cancer and birth defects or other reproductive harm, and phthalates which are known to the State of California to cause birth defects or other reproductive harm. For more information go to <http://www.p65warnings.ca.gov>.

WILTON

427 New Sanford Road
LaVergne, Tennessee 37086
Ph.: 800-274-6848
www.wiltontools.com

Part No. M-11753
Revision C 08/2018

Copyright © 2014 WILTON, a Division of JPW Industries, Inc.