

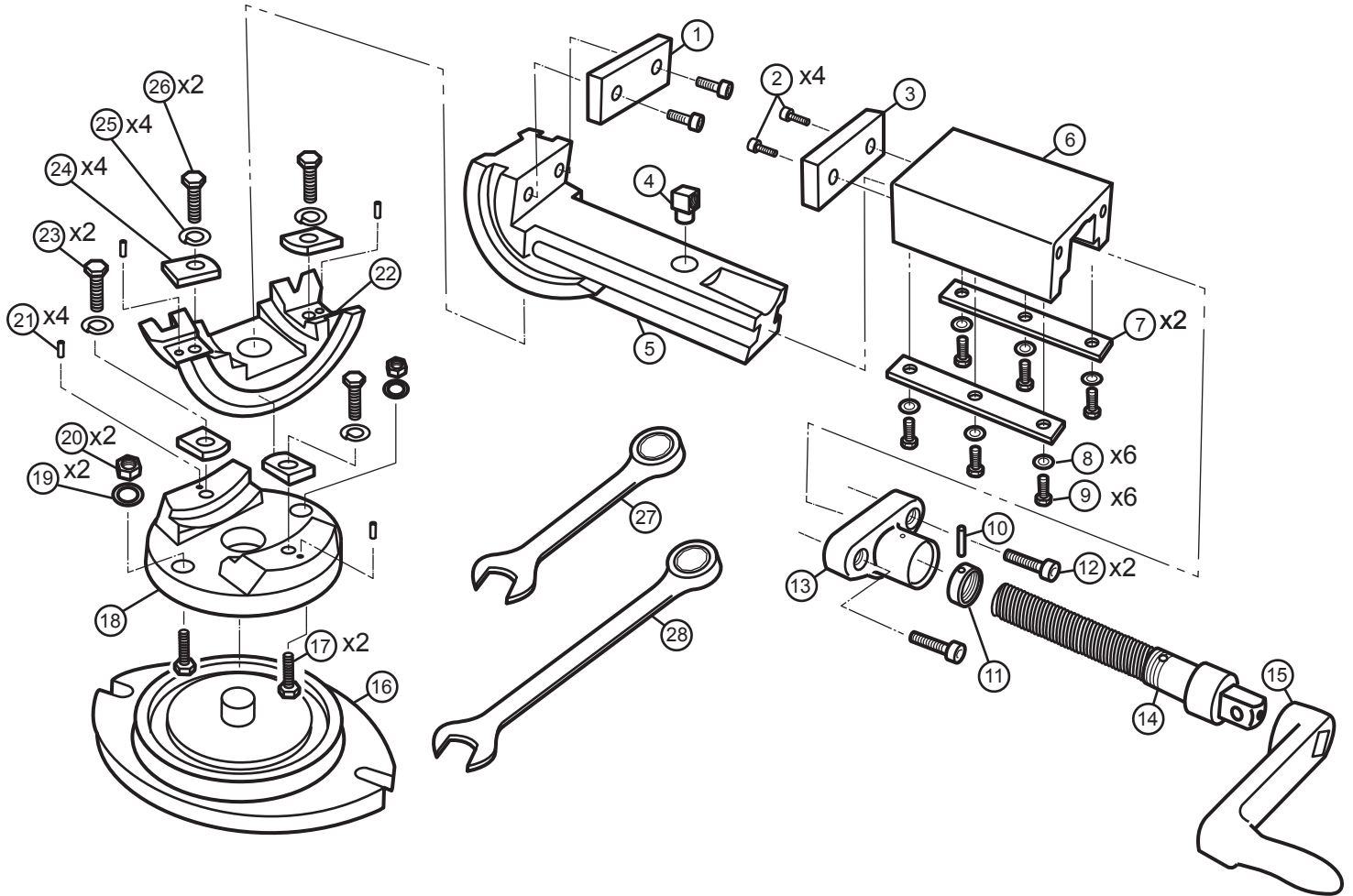

Super Precision 3-Axis Tilting Machine Vise Parts Diagram

6" Jaw Width, 6" Jaw Opening, 1-3/4" Jaw Depth

Stock #: 11804 Model #: TLT/SP-150



#	Part	Description	Qty
1	11804-01	Fixed Jaw Insert	1
2	11804-02	Socket Head Cap Screw	4
3	11804-03	Movable Jaw Insert	1
4	11804-04	Fixed Nut	1
5	11804-05	Vise Body	1
6	11804-06	Movable Jaw	1
7	11804-07	Slide Plate	2
8	11804-08	Flat Washer	6
9	11804-09	Hex Cap Screw	6
10	11804-10	Roll Pin	1
11	11804-11	Collar	1
12	11804-12	Socket Head Cap Screw	2
13	11804-13	Sleeve	1
14	11804-14	Clamp Screw	1

#	Part	Description	Qty
15	11804-15	Handle	1
16	11804-16	Swivel Base	1
17	11804-17	Hex Cap Screw	2
18	11804-18	Turret	1
19	11804-19	Flat Washer	2
20	11804-20	Hex Nut	2
21	11804-21	Pin	4
22	11804-22	Trunnion	1
23	11804-23	Hex Cap Screw	2
24	11804-24	Curved Washer	4
25	11804-25	Lock Washer	4
26	11804-26	Hex Cap Screw	2
27	11804-27	Combination Wrench	1
28	11804-28	Combination Wrench	1