



# 10 TON TUBE | PIPE BENDER

## SAFETY INSTRUCTIONS MANUAL



## 1 GENERAL

Operator and Supervisor Information

Signal Word Definition

Signal Word Panel

## 2 SIGNAL WORD PANEL - MACHINE FRONT

## 3 SIGNAL WORD PANEL - MACHINE BACK

## 4 SIGNAL WORDS

Warning Panel

Caution Panel

Notice Panel

## OPERATOR AND SUPERVISOR INFORMATION

This is one of four manuals supplied with your machine.

- **Installation Manual**
- **Safety Instructions Manual**
- **Operations Manual**
- **Maintenance Manual**

**READ ALL MANUALS BEFORE OPERATING MACHINERY.** Operating machinery before reading and understanding the contents of all four manuals greatly increases the risk of injury.

Each of the four machine manuals describes 'best practices' in handling, installing, operating and maintaining your machine. The contents of each manual is subject to change without notice due to improvements in the machinery or changes in National or International standards.

All rights reserved. Reproduction of this manual in any form, in whole or in part, is not permitted without the written consent of Edwards Manufacturing Company.

Keep all manuals close to the machine to allow for easy reference when necessary.

Provide operators with sufficient training and education in the basic functions of the machine prior to machine operation.

Do not allow for operation of the machine by unqualified personnel. Edwards Manufacturing Company is not liable for accidents arising from unskilled, untrained operation.

Do not modify or change the machine without written authorization from Edwards Manufacturing Company. Unauthorized modification to a machine may result in serious operator injury, machine damage and will void your machine warranty.

Never leave a powered machine unattended. Turn machinery **OFF** before walking away.

This machine is manufactured for use by able bodied and able minded operators only. Never operate machinery when tired or under the influence of drugs or alcohol.

Do not resell, relocate or export to a destination other than to the original point of sale. Edwards has designed this machine to meet the standards of the original receiving country and is not liable for meeting any governing body or performance standards beyond those of the original receiving country.

## SIGNAL WORD DEFINITION

### **DANGER**

Indicates a hazardous situation that, if not avoided, will result in death or serious injury.

### **WARNING**

Indicates a hazardous situation that, if not avoided, could result in death or serious injury.

### **CAUTION**

Indicates a hazardous situation that, if not avoided, could result in mild or moderate injury.

### **NOTICE**

Indicates information considered important, but not hazard related.



**WARNING:** This product can expose you to chemicals including Methyl Isobutyl Ketone which is known to the State of California to cause cancer and birth defects or other reproductive harm. For more information go to <http://www.p65warnings.ca.gov>.



**WARNING:** Some dust, fumes and gases created by power sanding, sawing, grinding, drilling, welding and other construction activities contain chemicals known to the State of California to cause cancer and birth defects or other reproductive harm. Some examples of these chemicals are:

- lead from lead based paint
- crystalline silica from bricks, cement and other masonry products
- arsenic and chromium from chemically treated lumber

Your risk of exposure varies, depending on how often you do this type of work. To reduce your exposure to these chemicals, work in a well-ventilated area and work with approved safety equipment, such as dust masks that are specifically designed to filter out microscopic particles. For more information go to <http://www.p65warnings.ca.gov/> and <http://www.p65warnings.ca.gov/> wood.

## SIGNAL WORD PANEL ON MACHINE

### **DANGER**

Critical machine safety information is identified on signal word labels. Labels are attached adjacent to the potentially hazardous locations of the machine. Reference the Safety Instruction Manual for additional information regarding the potentially hazardous condition identified on the label.









**Review ALL labels on the machinery, reference the operational precautions and safe operations sections within this manual before any operation activity is initiated.**

*Failure to read and understand the signal word labels affixed to the machinery may result in operator death or injury.*

# 10 TON TUBE/PIPE BENDER • SIGNAL WORD PANEL



# 10 TON TUBE/PIPE BENDER • SIGNAL WORD PANEL

DANGER		WARNING		NOTICE	
	Hydraulic accessory controls powered by Ironworker/ Porta-Power.		Shear/Crush Hazard Moving parts can cut and crush.		Read, understand, and follow all labels shown on the machine and described in the: • Safety Instructions Manual • Installation Manual • Operations Manual • Maintenance Manual
	Lockout power at Ironworker/ Porta-Power before servicing.		Fluid Injection Hazard Hydraulic fluid is under pressure. Hydraulic fluid powers moving parts.		Keep all manuals close for easy reference.
	Lockout power at Ironworker/ Porta-Power before servicing.		Keep guards in place		Trained and authorized personnel are to install, operate and service this machinery. Do not allow for operation of the machine by unqualified personnel. Personal protective equipment must be worn at all times during machinery operation.

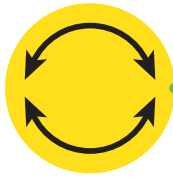

# WARNING PANEL

## **WARNING**



### **Shear/Crush Hazard**

Moving parts can cut and crush. Keep hands clear while operating. Lockout power before servicing. Immediately replace guards after adjustment, repair or service.



### **Wear Personal Protective Equipment**

To avoid physical hazard, always wear personal protective equipment. Wear protective eyewear, clothing, gloves, footwear, head-gear and hearing protection while operating or servicing this machinery.



### **Fluid Injection Hazard**

Hydraulic hoses and cylinders are under pressure. Pressurized fluid can pierce skin and cause severe injury. To avoid physical hazard, always wear personal protective equipment. Keep hands clear while operating. Lockout power before servicing. Immediately replace guards after adjustment, repair or service.



### **Do Not Operate With Guard Removed**

Physical barriers and guards have been designed and installed to protect the Operator from moving parts that can pinch, cut and crush. Keep hands clear while operating. Lockout power before servicing. Immediately replace guards after adjustment, repair or service to moving parts.

# CAUTION PANEL

## **CAUTION**

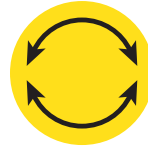

### **Tilting Operation**

The head-frame of your Edwards 10 Ton Tube/Pipe Bender is mounted with a yoke and pin to a sleeve and stop mechanism in the bender stand. This mounting configuration allows for the bender head-frame to be operated in either a horizontal or vertical orientation. Exercise care when changing the operating position of the bender and during operation of the bender.



### **Tilting Operation**

The bender can be operated in either a horizontal or vertical position. Exercise care when changing the operating position of the bender and during operation of the bender.

# NOTICE PANEL

## NOTICE



### Bender Operation

Edwards 10 Ton Tube / Pipe Bender machinery is capable of many functions. This manual outlines the basic functions associated with typical bender operations and is neither intended to create a comprehensive list of, nor describe every operation possible with a bender tool. **Bender operations are dangerous and require extreme care and caution in the safe installation, operation and maintenance of the machinery. Edwards Manufacturing Company strongly suggests reading and understanding all manuals associated with the machinery as well as obtaining certified, technical, industrial machinery operations and maintenance training to reduce the risk of injury. Regardless of the contents of the machinery manuals Edwards Manufacturing Company will not be held liable for accidents caused by lack of training.**



### Refer to All Manuals

Each manual that comes with this machine contains critical instructions regarding proper operations, safety, installation and maintenance procedures. Understand the contents of each manual thoroughly. Failure to follow proper procedures may result in serious operator injury, machine damage and will void your machine warranty. Keep the manuals close to the machine for easy reference.



### Wear Personal Protective Equipment

To avoid physical hazard, always wear personal protective equipment. Wear protective eyewear, clothing, gloves, footwear, head-gear and hearing protection while operating or servicing this machinery.



# IRONWORKERS

1107 SYKES ST., ALBERT LEA, MN 56007 800-373-8206 [WWW.EDWARDSIRONWORKERS.COM](http://WWW.EDWARDSIRONWORKERS.COM)





# 10 TON TUBE | PIPE BENDER

## INSTALLATION MANUAL



## 1 GENERAL

Operator and Supervisor Information

Signal Word Definition

Signal Word Panel

## 2 INSTALLING THE BENDER

Environmental Requirements at Work Station

Receiving the Bender

Unpacking/Moving the Bender

## 3 HYDRAULIC POWER

Powering with an Edwards Ironworker

Powering with an Edwards Porta Power

## OPERATOR AND SUPERVISOR INFORMATION

This is one of four manuals supplied with your machine.

- **Installation Manual**
- **Safety Instructions Manual**
- **Operations Manual**
- **Maintenance Manual**

**READ ALL MANUALS BEFORE OPERATING MACHINERY.** Operating machinery before reading and understanding the contents of all four manuals greatly increases the risk of injury.

Each of the four machine manuals describes 'best practices' in handling, installing, operating and maintaining your machine. The contents of each manual is subject to change without notice due to improvements in the machinery or changes in National or International standards.

All rights reserved. Reproduction of this manual in any form, in whole or in part, is not permitted without the written consent of Edwards Manufacturing Company.

Keep all manuals close to the machine to allow for easy reference when necessary.

Provide operators with sufficient training and education in the basic functions of the machine prior to machine operation.

Do not allow for operation of the machine by unqualified personnel. Edwards Manufacturing Company is not liable for accidents arising from unskilled, untrained operation.

Do not modify or change the machine without written authorization from Edwards Manufacturing Company. Unauthorized modification to a machine may result in serious operator injury, machine damage and will void your machine warranty.

Never leave a powered machine unattended. Turn machinery **OFF** before walking away.

This machine is manufactured for use by able bodied and able minded operators only. Never operate machinery when tired or under the influence of drugs or alcohol.

Do not resell, relocate or export to a destination other than to the original point of sale. Edwards has designed this machine to meet the standards of the original receiving country and is not liable for meeting any governing body or performance standards beyond those of the original receiving country.

## SIGNAL WORD DEFINITION

### **DANGER**

Indicates a hazardous situation that, if not avoided, will result in death or serious injury.

### **WARNING**

Indicates a hazardous situation that, if not avoided, could result in death or serious injury.

### **CAUTION**

Indicates a hazardous situation that, if not avoided, could result in mild or moderate injury.

### **NOTICE**

Indicates information considered important, but not hazard related.



**WARNING:** This product can expose you to chemicals including Methyl Isobutyl Ketone which is known to the State of California to cause cancer and birth defects or other reproductive harm. For more information go to <http://www.p65warnings.ca.gov>.



**WARNING:** Some dust, fumes and gases created by power sanding, sawing, grinding, drilling, welding and other construction activities contain chemicals known to the State of California to cause cancer and birth defects or other reproductive harm. Some examples of these chemicals are:

- lead from lead based paint
- crystalline silica from bricks, cement and other masonry products
- arsenic and chromium from chemically treated lumber

Your risk of exposure varies, depending on how often you do this type of work. To reduce your exposure to these chemicals, work in a well-ventilated area and work with approved safety equipment, such as dust masks that are specifically designed to filter out microscopic particles. For more information go to <http://www.p65warnings.ca.gov/> and <http://www.p65warnings.ca.gov/wood>.

## SIGNAL WORD PANEL ON MACHINE

### **DANGER**

Critical machine safety information is identified on signal word labels. Labels are attached adjacent to the potentially hazardous locations of the machine. Reference the Safety Instruction Manual for additional information regarding the potentially hazardous condition identified on the label.

**Review ALL labels on the machinery, reference the operational precautions and safe operations sections within this manual before any operation activity is initiated.**

***Failure to read and understand the signal word labels affixed to the machinery may result in operator death or injury.***

# INSTALLING THE BENDER

This manual provides installation requirements for the Edwards 10 Ton Tube/Pipe Bender.

**ALL EDWARDS HYDRAULIC ACCESSORY TOOLS ARE POWERED BY AN EDWARDS IRONWORKER OR EDWARDS PORTA-POWER, PORTABLE HYDRAULIC POWER-PLANT.**

**REFER TO SAFETY, INSTALLATION, OPERATIONS AND MAINTENANCE MANUALS FOR THE EDWARDS POWER-PLANT YOU ARE USING TO OPERATE YOUR EDWARDS HYDRAULIC ACCESSORY TOOL.**

## Environmental Requirements at Work Station

### NOTICE

The work station environment for your Edwards 10 Ton Tube/Pipe Bender must meet the following minimum requirements:

- **Ambient temperature:** 7.2°C - 43.3°C [45°F - 110°F]
- **Relative humidity:** No greater than 90% relative humidity.
- **Floor area:** Assure that the machinery work area provides for a stable, adequately sized and load rated floor area for material movement to and from the machinery work stations.
- **Shelter:** Protect your machinery from water, salts and corrosive elements.
- **Lighting:** 500LUX (50 footcandles) minimum.

## Receiving the Bender

### **WARNING**

Edwards Hydraulic Accessory Tools are fully assembled and are shipped either by palletized custom wooden crate or by shrink-wrapped wooden pallet for ease of transport and receiving.

Inspect the packaging for damage and follow shipping/receiving instructions as listed on the packaging prior to receiving the tool into your facility.

When receiving your Hydraulic Accessory Tool, be prepared to safely move your machinery with a fork-lift rated for the following equipment weights:

#### **Minimum Machinery Weights**

10 Ton Tube/Pipe Bender	226.79kg/500lb
-------------------------	----------------

**Utilize best practices for fork-lift operation.** Handle material as close to the drive surface as possible with the widest spread and deepest penetration of forks effective to service the pallet. Forks should be adjusted and locked into the safety detent closest to the maximum available fork spread.

## Unpacking/Moving the Bender

Your Edwards 10 Ton Tube/Pipe Bender includes surface and remotely mounted electrical cabling and hydraulic lines. Exercise caution when removing the factory supplied packaging. Do not cut electrical wires or hydraulic hoses.

1. Carefully remove the wooden blocking from under the three wheeled base and carefully roll the tool off of the shipping pallet.
2. Engage the third wheel by pushing the kickstand mechanism down with your foot. Carefully roll the tool to the workstation.
3. Locate your bender directly adjacent to the Edwards Ironworker or Porta Power. **Ensure that power controls of the Ironworker or Porta Power are within arms-reach of the bender tool.**

## Hydraulic Power



Your Edwards Tube/Pipe Bender is factory assembled and tested for optimum performance when powered by Edwards Manufacturing Company rated hydraulic power supplies.

The Bender is powered by either an Edwards Ironworker with the factory installed Hydraulic Accessory Control Package or an Edwards Porta-Power, 5hp, 3000psi, portable power unit.

### **ALTERNATE POWER SOURCES ARE NOT RECOMMENDED AND MAY COMPROMISE MACHINE OPERATION, MACHINE HYDRAULIC WARRANTY AND OPERATOR SAFETY.**

Follow electrical connection installation instructions for power supply as set forth within the Installation Manual of the Edwards Ironworker or Porta-Power.

## Powering with an Edwards Ironworker

Power selection controls are located adjacent to the starter on the feed side of the machine. Hydraulic quick connections and accessory controls are located on the drop-off side or end cap of the machine.

With the Ironworker power off, install Bender hoses, power and control. **Assure your M12 connections are seated properly. Align M12 male and female fittings so that keyed surfaces align. Misalignment of surfaces will prohibit correct operation.**

- Install the Bender male and female accessory hydraulic hoses to the ironworker male and female quick-connect hydraulic fittings. Both fittings have a detent ball setting that must be aligned to couple and uncouple hoses.
- Remove the safety cap at the push button port. Attach the Bender hand control male mil. spec. control cable to the female mil. spec. accessory control port at your Ironworkers Hydraulic Accessory package. Attach the yellow limit switch cable to the limit switch port of the ironworker.

**With all Ironworker and Bender stations clear of hands, tools, tooling, material or debris, power up the Ironworker by depressing the green button on the starter box.**

With the power on, your Ironworker machine will return to a neutral position.

Turn the 3-position switch on the front of the machine case to the Accessory position. This operation disables the Ironworker and switches control to the accessory hand control.

Test the Bender operation by pressing the OUT control button. Once pressed, the cylinder will extend. Releasing pressure on the OUT control button will stop the cylinder. Test the Bender operation by pressing the IN control button. Once pressed, the cylinder will be retracted back into the cylinder enclosure. Releasing pressure on the IN control button will stop the cylinder.

Test the limit switch by extending the cylinder until the auto stop meets its positive stop.

Press the red e-stop button to kill power at the Ironworker. To reset power, twist the e-stop button and push start button at the Ironworker.

When disconnecting your Bender, simply reverse procedure. **Replace the safety cap at the push button port to restore power to your Ironworker.**

## Powering with an Edwards Porta-Power

Your Edwards Porta-Power 5hp / 3000psi / Portable Power Unit will power all your Edwards Hydraulic Accessories.

Follow electrical connection installation instructions as set forth within these sections of the Installation Manual:

With the Edwards Porta-Power off, install accessory hoses, power and control. **Assure your M12 connections are seated properly. Align M12 male and female fittings so that keyed surfaces align. Misalignment of surfaces will prohibit correct operation.**

- Install the male and female Bender hydraulic hoses to the Porta-Power male and female quick connect hydraulic fittings adjacent to the starterbox. Both fittings have a detent ball setting that must be aligned to couple and uncouple hoses.
- Remove the safety cap at the push button port. Attach the Bender hand control, male mil. spec. control cable to the female mil. spec. accessory push button port on the Porta-Power case. Attach the yellow limit switch cable to the limit switch port of the Porta-Power.

**With all Ironworker and Bender stations clear of hands, tools, tooling, material or debris, power up the Porta-Power by depressing the green button on the starter box.**

With the power on, your Bender is in a neutral position.

Test the Bender operation by pressing the OUT control button. Once pressed, the cylinder will extend. Releasing pressure on the OUT control button will stop the cylinder. Test the Bender operation by pressing the IN control button. Once pressed, the cylinder will be retracted back into the cylinder enclosure. Releasing pressure on the IN control button will stop the cylinder.

Test the limit switch by extending the cylinder until the auto stop meets its positive stop.

If the machine fails to cycle, power down the Porta-Power by pressing the red button on the starterbox, consult the trouble shooting section of the Operations Manual.

Press the red e-stop button on the hand control to kill power at the Porta Power. To reset power, twist the e-stop button and push start button at Porta Power.

When disconnecting your Bender, simply reverse procedure. **Replace the safety cap at the push button port to restore power to your Porta Power.**



# IRONWORKERS

1107 SYKES ST., ALBERT LEA, MN 56007 800-373-8206 [WWW.EDWARDSIRONWORKERS.COM](http://WWW.EDWARDSIRONWORKERS.COM)



# 10 TON TUBE | PIPE BENDER

## OPERATIONS MANUAL

SERIAL NUMBER: \_\_\_\_\_



# OPERATIONS MANUAL TABLE OF CONTENTS

## **1 GENERAL**

- Company Profile
- Machine Identification
- Warranty
- Operator and Supervisor Information
- Signal Word Definition
- Signal Word Panel
- Operational Precautions
- Machine Operations

## **4 HYDRAULIC POWER SOURCES**

- Powering with an Edwards Ironworker
- Powering with an Edwards Porta-Power

## **6 OPERATIONS DIAGRAM**

## **7 COMPONENT/BASE OPERATIONS**

- Tilting Head-Frame Operation
- Base Operation

## **8 DIE SET DIAGRAM**

## **9 DIE SET OPERATIONS**

## **10 HEAD FRAME DIAGRAM**

## **11 PROTRACTOR/AUTO-STOP CONTROL**

- Protractor
- Auto-Stop Control

## **12 BENDING**

- Loading Material
- Lubrication
- Bending

## **13 TROUBLESHOOTING**



# COMPANY PROFILE



Edwards Manufacturing Company manufactures a full line of high quality, low maintenance hydraulic ironworking machines, associated tooling and accessories that are used in the steel fabrication industry. With proper operation, care, and maintenance, your Edwards Ironworker or Hydraulic Accessory

Tool will provide consistent, long-term service. Please take time to study this Operator's Manual carefully to fully understand Ironworker and Hydraulic Accessory Tool safety procedures, set-up, operation, care, maintenance, troubleshooting and warranty coverage prior to putting the machine into production. Any questions not answered within this manual can be directed to your local Edwards Ironworker dealer or factory representative.

## Contact the factory:

### EDWARDS MANUFACTURING COMPANY

1107 Sykes Street  
Albert Lea, MN 56007  
507 373 8206 PHONE  
507 373 9433 FAX  
[www.edwardsironworkers.com](http://www.edwardsironworkers.com)

*General Questions:*  
[sales@edwardsmfg.us](mailto:sales@edwardsmfg.us)

*Service Questions:*  
[service@edwardsmfg.us](mailto:service@edwardsmfg.us)

## Contact your dealer:

# WARRANTY

Edwards Manufacturing Company will, within one (1) year of date of original purchase (proof of purchase required), replace F.O.B. the factory, any goods, excluding punches, dies and shear blades, which are defective in materials or workmanship provided that the buyer return the defective goods, freight pre-paid, to the seller, which shall be the buyer's sole and exclusive remedy for the defective goods. Hydraulic components are subject to their manufacturer's warranty.

Edwards Manufacturing Company will, within thirty (30) days of date of original purchase (proof of purchase required), replace F.O.B. the factory, any punches, dies and/or shear blades, which are defective in materials or workmanship.

This warranty does not apply to machines and/or components which have been altered, changed or modified in any way, or subjected to abusive and abnormal use, inadequate maintenance and lubrication, or subjected to use beyond seller recommended capacities and specifications. Edwards Manufacturing Company shall not be liable for labor costs expended on such goods or consequential damages. Edwards Manufacturing Company shall not be liable to the purchaser or any other person for loss, down-time, or damage directly or indirectly arising from the use of the goods or from any other cause. No officer, employee, or agent of Edwards Manufacturing Company is authorized to make any oral representations or warranty of fitness or to waive any of the foregoing terms and none shall be binding on Edwards Manufacturing Company.

NOTE: Edwards Manufacturing is a division of JPW Industries, Inc. References in this document to Edwards also apply to JPW Industries, Inc., or any of its successors in interest to the Edwards brand.

# MACHINE IDENTIFICATION

Your Edwards 10 Ton Tube/Pipe Bender has been serialized for quality control, product traceability and warranty enforcement. Please refer to the aluminum identification tag with engraved serial number, electrical and power specifications when ordering parts or filing a warranty claim.

# OPERATOR AND SUPERVISOR INFORMATION

This is one of four manuals supplied with your machine.

- Safety Instructions Manual
- Installation Manual
- Operations Manual
- Maintenance Manual

**READ ALL MANUALS BEFORE OPERATING MACHINERY.** Operating machinery before reading and understanding the contents of all four manuals greatly increases the risk of injury.

Each of the four machine manuals describes 'best practices' in handling, installing, operating and maintaining your machine. The contents of each manual is subject to change without notice due to improvements in the machinery or changes in National or International standards.

All rights reserved. Reproduction of this manual in any form, in whole or in part, is not permitted without the written consent of Edwards Manufacturing Company.

Keep all manuals close to the machine to allow for easy reference when necessary.

Provide operators with sufficient training and education in the basic functions of the machine prior to machine operation.

Do not allow for operation of the machine by unqualified personnel. Edwards Manufacturing Company is not liable for accidents arising from unskilled, untrained operation.

Do not modify or change the machine without written authorization from Edwards Manufacturing Company. Unauthorized modification to a machine may result in serious operator injury, machine damage and will void your machine warranty.

Never leave a powered machine unattended. Turn machinery **OFF** before walking away.

This machine is manufactured for use by able bodied and able minded operators only. Never operate machinery when tired or under the influence of drugs or alcohol.

Do not resell, relocate or export to a destination other than to the original point of sale. Edwards has designed this machine to meet the standards of the original receiving country and is not liable for meeting any governing body or performance standards beyond those of the original receiving country.

## SIGNAL WORD DEFINITION



Indicates a hazardous situation that, if not avoided, will result in death or serious injury.



Indicates a hazardous situation that, if not avoided, could result in death or serious injury.



Indicates a hazardous situation that, if not avoided, could result in mild or moderate injury.



Indicates information considered important, but not hazard related.

## SIGNAL WORD PANEL ON MACHINE



Critical machine safety information is identified on signal word labels. Labels are attached adjacent to the potentially hazardous locations of the machine. Reference the Safety Instruction Manual for additional information regarding the potentially hazardous condition identified on the label.

**Review ALL labels on the machinery, reference the Safety Instructions Manual, the operational precautions and the safe operations sections within this manual before any operation activity is initiated.**

*Failure to read and understand the signal word labels affixed to the machinery may result in operator death or injury.*

# OPERATIONAL PRECAUTIONS

## **DANGER**

Reasonable, common sense safety precautions should be observed when operating the Ironworker or Hydraulic Accessory Tool. The following precautions are described in order of their hazard.

### Electrical Hazard

Dangerous high voltages are present inside the electrical enclosure of this product. Only qualified, authorized, maintenance or service personnel should gain access to the electrical panel.

### Lockout Power

Danger, circuits are live. Lockout / tagout upstream power source before any maintenance activity is performed.

### Shear / Crush Hazard

Moving parts can cut and crush. Keep hands clear when servicing and maintaining the Ironworker.

### Hydraulic Fluid Hazard

Hydraulic hoses and cylinders are under pressure. Pressurized fluid can pierce skin and cause severe injury. To avoid physical hazard, always wear personal protective equipment when servicing / maintaining the Ironworker.

### Do Not Operate With Guard Removed

Physical barriers and guards have been designed and installed (where possible) to protect personnel from moving parts that can pinch, cut and crush. If it is necessary to remove guarding when servicing the Bender, immediately replace guards after service and prior to power being restored to the machinery.

### Refer to Manuals

For safe installation, operation and maintenance of the machine, read:

- Installation Manual
- Safety Instructions Manual
- Operations Manual
- Maintenance Manual

### Wear Personal Protective Equipment

To avoid physical hazard wear protective eyewear, clothing, gloves, footwear, head-gear and hearing protection.



**WARNING:** This product can expose you to chemicals including Methyl Isobutyl Ketone which is known to the State of California to cause cancer and birth defects or other reproductive harm. For more information go to <http://www.p65warnings.ca.gov>.



**WARNING:** Some dust, fumes and gases created by power sanding, sawing, grinding, drilling, welding and other construction activities contain chemicals known to the State of California to cause cancer and birth defects or other reproductive harm. Some examples of these chemicals are:

- lead from lead based paint
- crystalline silica from bricks, cement and other masonry products
- arsenic and chromium from chemically treated lumber

Your risk of exposure varies, depending on how often you do this type of work. To reduce your exposure to these chemicals, work in a well-ventilated area and work with approved safety equipment, such as dust masks that are specifically designed to filter out microscopic particles. For more information go to <http://www.p65warnings.ca.gov/> and <http://www.p65warnings.ca.gov/wood>.

## MACHINE OPERATIONS

Edwards Benders are designed to bend solid round, Schedule 40 pipe, tube, square tube, and d.o.m. tube.

**ALL EDWARDS HYDRAULIC ACCESSORY TOOLS ARE POWERED BY AN EDWARDS IRONWORKER OR EDWARDS PORTA POWER, PORTABLE HYDRAULIC POWER-PLANT.**

**REFER TO THE SAFETY, INSTALLATION, OPERATIONS AND MAINTENANCE MANUALS FOR THE EDWARDS POWER-PLANT YOU ARE USING TO OPERATE YOUR EDWARDS HYDRAULIC ACCESSORY TOOL.**

**The following pages detail the proper operation procedures for setting up and safely operating the Edwards 10 Ton Tube/Pipe Bender.**

# HYDRAULIC POWER SOURCES



Hydraulic Accessory Tool Controls



Ironworker Hydraulic Accessory Package

## **WARNING**

Your Edwards Tube/Pipe Bender is factory assembled and tested for optimum performance when powered by Edwards Manufacturing Company rated hydraulic power supplies.

The Bender is powered by either an Edwards Ironworker with the factory installed Hydraulic Accessory Control Package or an Edwards Porta-Power, 5hp, 3000psi, portable power unit.

**ALTERNATE POWER SOURCES ARE NOT RECOMMENDED AND MAY COMPROMISE MACHINE OPERATION, MACHINE HYDRAULIC WARRANTY AND OPERATOR SAFETY.**

Follow electrical connection installation instructions for power supply as set forth within the Installation Manual of the Edwards Ironworker or Porta-Power.

## Powering with an Edwards Ironworker

Power selection controls are located adjacent to the starter on the feed side of the machine. Hydraulic quick connections and accessory controls are located on the drop-off side or end cap of the machine.

With the Ironworker power off, install Bender hoses, power and control. **Assure your M12 connections are seated properly. Align M12 male and female fittings so that keyed surfaces align. Misalignment of surfaces will prohibit correct operation.**

- Install the Bender male and female accessory hydraulic hoses to the ironworker male and female quick-connect hydraulic fittings. Both fittings have a detent ball setting that must be aligned to couple and uncouple hoses.
- Remove the safety cap at the push button port. Attach the Bender hand control male mil. spec. control cable to the female mil. spec. accessory control port at your Ironworkers Hydraulic Accessory package. Attach the yellow M12 limit switch cable to the limit switch port of the ironworker.

With all Ironworker and Bender stations clear of hands, tools, tooling, material or debris, power up the Ironworker by depressing the green button on the starter box.

With the power on, your Ironworker machine will return to a neutral position.

Turn the 3-position switch on the front of the machine case to the Accessory position. This operation disables the Ironworker and switches control to the accessory hand control.

Test the Bender operation by depressing the OUT control button. Once depressed, the cylinder will extend. Releasing pressure on the OUT control button will stop the cylinder. Test the Bender operation by depressing the IN control button. Once depressed, the cylinder will be retracted back into the cylinder enclosure. Releasing pressure on the IN control button will stop the cylinder. Test the limit switch by extending the cylinder until the auto stop meets its positive stop.

Depress the red e-stop button to kill power at the Ironworker. To reset power, twist the e-stop button and push start button at the Ironworker.

When disconnecting your Bender, simply reverse procedure. **Replace the safety cap at the push button port to restore power to your Ironworker.**



Edwards Porta-Power



## Powering with an Edwards Porta-Power

Your Edwards Porta-Power 5hp / 3000psi / Portable Power Unit will power all your Edwards Hydraulic Accessories.

Follow electrical connection installation instructions as set forth within these sections of the Installation Manual:

With the Edwards Porta-Power off, install accessory hoses, power and control. **Assure your M12 connections are seated properly. Align M12 male and female fittings so that keyed surfaces align. Misalignment of surfaces will prohibit correct operation.**

- Install the male and female Bender hydraulic hoses to the Porta-Power male and female quick connect hydraulic fittings adjacent to the starterbox. Both fittings have a detent ball setting that must be aligned to couple and uncouple hoses.
- Remove the safety cap at the push button port. Attach the Bender hand control, male mil. spec. control cable to the female mil. spec. accessory push button port on the Porta-Power case. Attach the yellow M12 limit switch cable to the limit switch port of the Porta-Power.

**With all Ironworker and Bender stations clear of hands, tools, tooling, material or debris, power up the Porta-Power by depressing the green button on the starter box.**

With the power on, your Bender is in a neutral position.

Test the Bender operation by depressing the OUT control button. Once depressed, the cylinder will extend. Releasing pressure on the OUT control button will stop the cylinder. Test the Bender operation by depressing the IN control button. Once depressed, the cylinder will be retracted back into the cylinder enclosure. Releasing pressure on the IN control button will stop the cylinder.

Test the limit switch by extending the cylinder until the auto stop meets its positive stop.

If the machine fails to cycle, power down the Porta-Power by depressing the red button on the starterbox, consult the trouble shooting section of the Operations Manual.

Depress the red e-stop button on the hand control to kill power at the Porta Power. To reset power, twist the e-stop button and push start button at Porta Power.

When disconnecting your Bender, simply reverse procedure. **Replace the safety cap at the push button port to restore power to your Porta Power.**

# 10 TON TUBE/PIPE BENDER OPERATIONS DIAGRAM



# COMPONENT/BASE OPERATIONS



Vertical Head-Frame Position



Horizontal Head-Frame Position

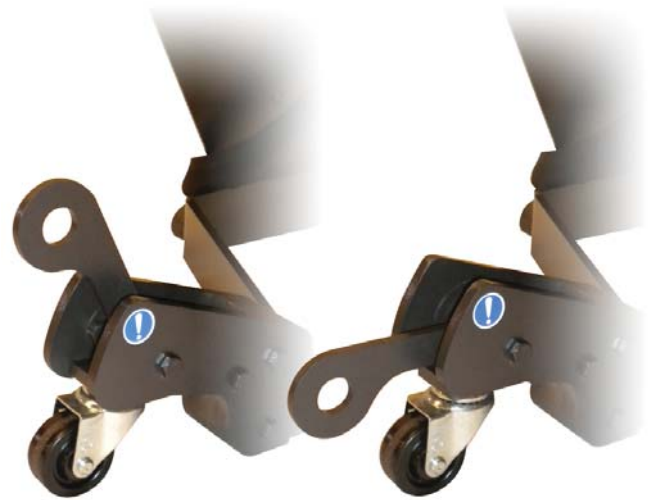

Left: Kickstand up (disengaged) Right: Kickstand down (engaged)

 **CAUTION**

## Tilting Head-Frame Operation

The head-frame of your Edwards 10 Ton Tube/Pipe Bender is mounted with a yoke and pin to a sleeve and stop mechanism in the bender stand. This mounting configuration allows for the bender head-frame to be operated in either a horizontal or vertical orientation. Positive stops at 0 and 90 degrees provide for a flexible and stable operation of the bender when working with complex bending shapes or long setups.

Rotate the tilting head frame with caution. To rotate the head-frame, release the hand screw on the top side of the rotational sleeve, rotate the head-frame slowly utilizing both hands as a cradle at the top (die end) of the head frame to the desired 0 or 90 degree location. Secure the hand screw in the bender final working position

**NOTICE**

## Base Operation

The heavy duty, ½" formed steel plate design is balanced like a tripod and rolls on 3 wheels. The "kickstand" at the rear of the bender base allows you to push the kickstand down with your foot to deploy the swiveling caster and easily roll the bender to your work station. When located in the ideal location, flip the kickstand up to disengage the swiveling caster and stabilize the bender on the floor.

# DIE SET DIAGRAM

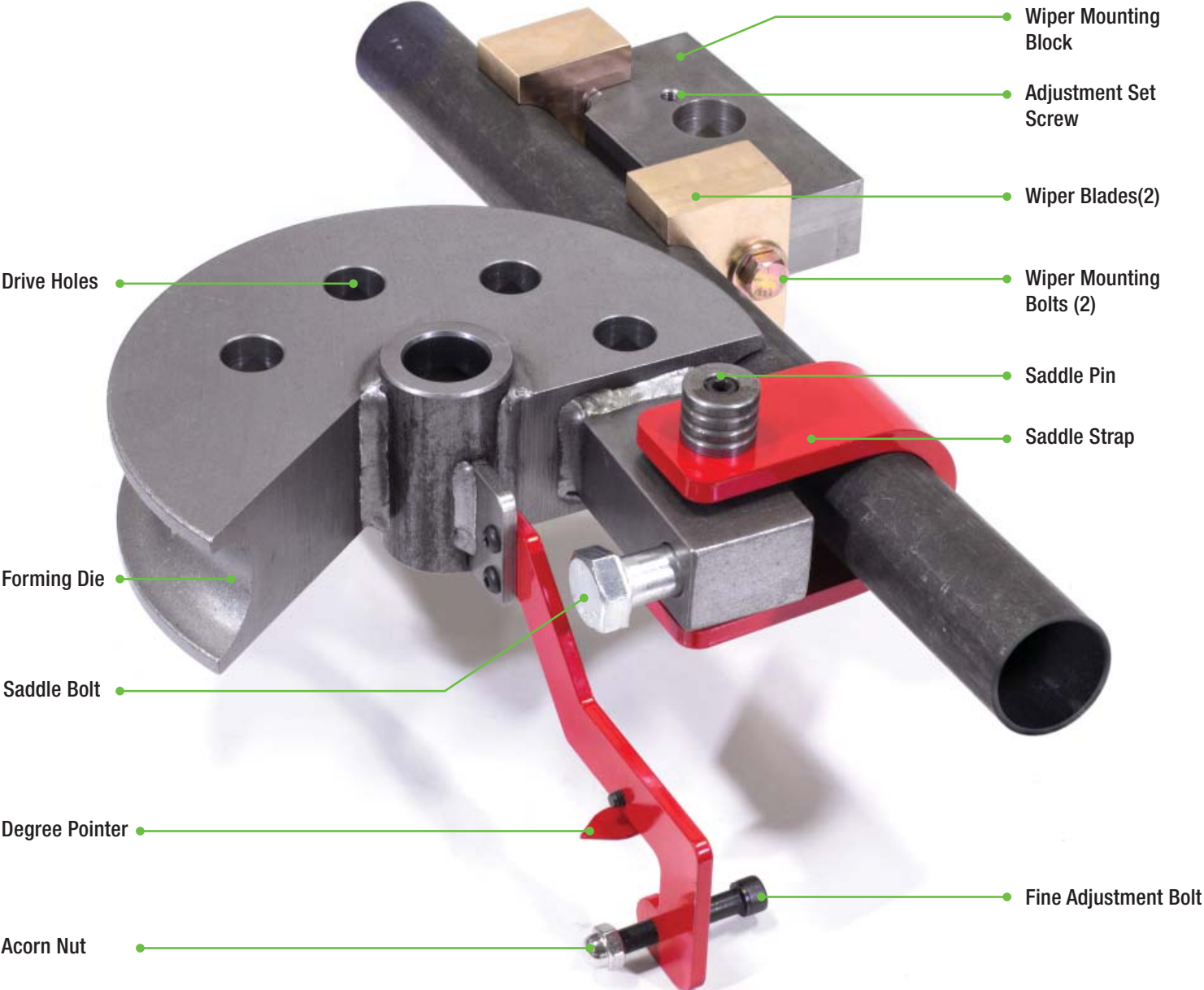



# DIE SET OPERATIONS



## **WARNING**

Your Edwards 10 Ton Bender will bend solid round, schedule 40 pipe, tube and d.o.m. tubing when equipped with the proper, matched die sets and careful operation.

Die sets are designed to center the bending work within the head-frame assembly. This design feature symmetrically distributes bending forces through the head-frame, eliminating asymmetrical stress, torque and premature wear of your machine.

**All die components are matched as a set and are specific to the product being bent. Never mix and match die set components. Mixing die set components may damage the product being bent, machine operation, and operator safety. Damage to the bender due to mixed die components may compromise machine warranty.**

**Die sets contain wearing parts. Periodic cleaning and/or replacement of wearing surfaces is required to maintain the highest quality finished parts.**

## **Die Set Installation**

With the head-frame in its horizontal position, carefully load the forming die assembly into the head-frame using the 1-1/4" diameter hardened pin. Make sure to load with the die identification specifications visible or the die will be installed backwards.

Install the wiper assembly in the head-frame by securing the assembly with the 1-1/4" diameter hardened pin between the top and bottom sections of the head-frame assembly. Make sure to load with the die identification specifications visible and the wiper blades facing the forming die or the die will be installed backwards.

Check to see that the die set components are all "seated" properly in the head-frame and that all securing pins are fully engaged in their proper locations.

Slide a sample piece of the material being bent into the die set. If alignment of the Wiper Assembly to the Forming Die is required use the Adjustment Set-Screw to center the Wiper to the forming die. Secure the alignment with the jamb-nut provided. **Failure to properly align wiper assembly with forming die may damage the product being bent, die set, machine or operator.**

# HEAD FRAME DIAGRAM

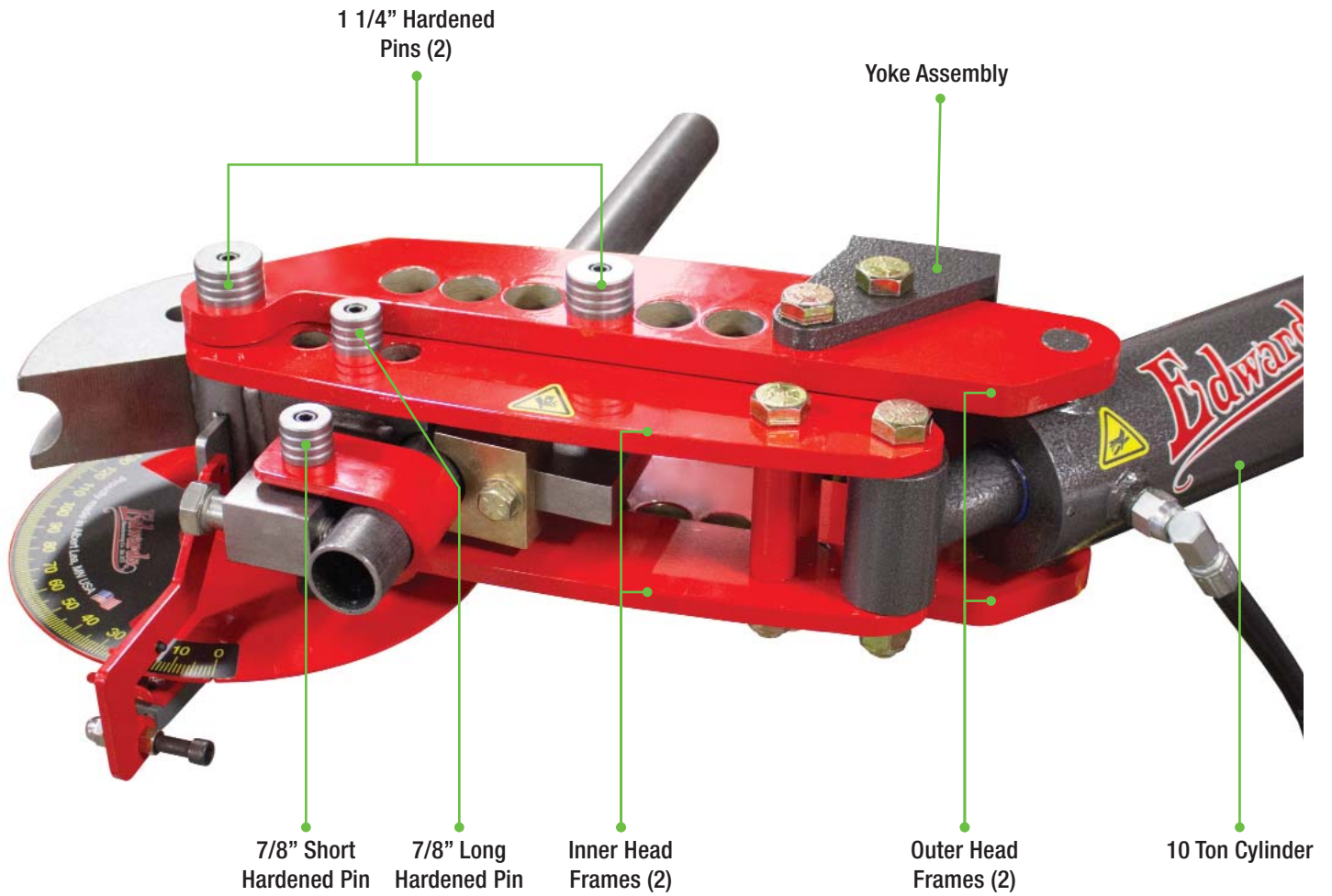

# PROTRACTOR/AUTO-STOP CONTROL

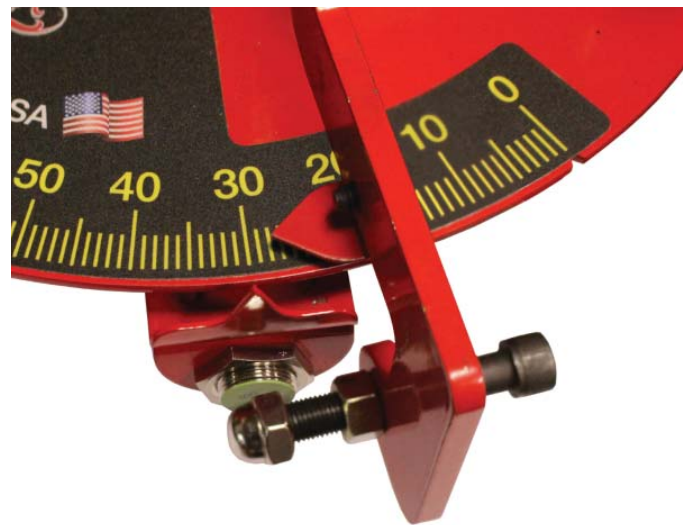
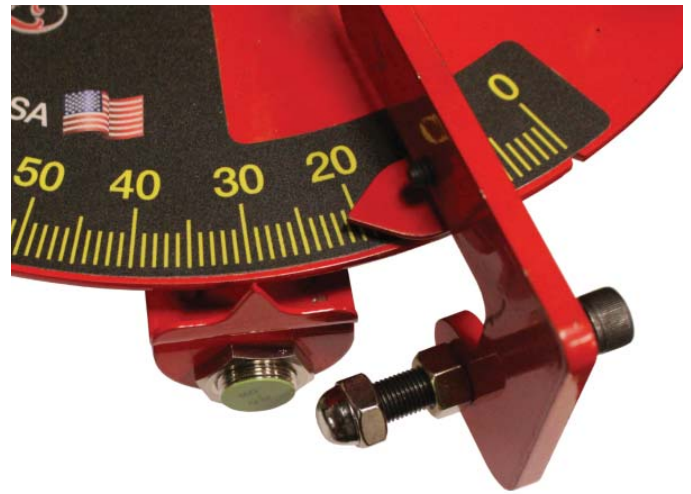

Activation range 1/16"

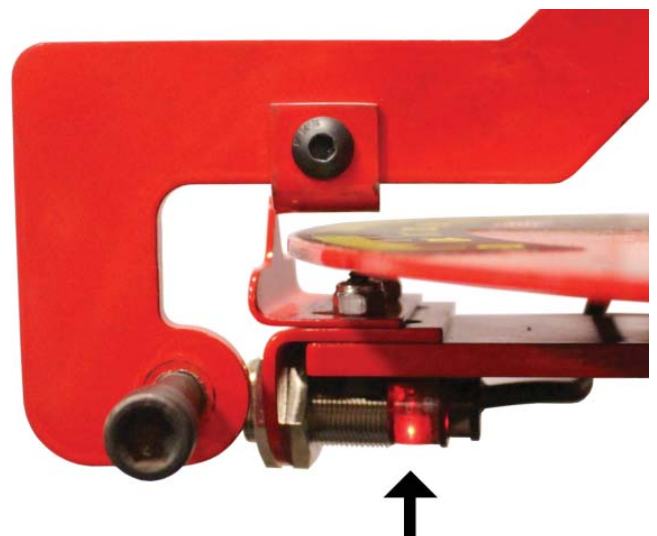

When activated, the proximity switch will light up.

## NOTICE

### Protractor

The protractor wheel will aid you in bending your product to the desired angle. If adjustment of your protractor is required, simply loosen the protractor mounting screws and rotate the dial to align with the 0-degree position. Re-secure the mounting screws to continue operation.

### Auto-Stop Control

The Auto-Stop Control is a bending aid that, once your bend is set up to your satisfaction, can be adjusted to reproduce that bend in successive sections of material.

This tool is ideally suited for light manufacturing where repeatability of bent product is desired. If fine adjustment of the Auto-Stop Control is desired, rotate the shoulder bolt clockwise or counterclockwise as necessary.

# BENDING



## Loading Material

Rotate and secure the bender head-frame in either the vertical or horizontal working position. If working with long sections of material, be prepared to support your material with a material rest or roller (provided by user). Place the leading end of the material to be bent between the forming die assembly and wiper bar assembly. Capture the material with the saddle strap and saddle pin. Secure the material by tightening the saddle bolt down on the material.

## Lubrication

To achieve the highest quality finished bend in your material, as well as the longest life from the bearing surfaces of your die components, a liberal amount of lubrication should be applied to the bearing surfaces as follows:

### Schedule 40 Pipe

- Lubricate wiper blades

### Tubing

- Lubricate wiper blades

### Square Tubing

- Lubricate wiper blades

### Solid Round

- Lubricate wiper blades

Lubricant can be mineral or vegetable-based, solid bodied or spray aerosol.

## Bending

Install your material into the forming die and wiper bar assembly. Secure the material with the matched saddle strap and 7/8" (short) saddle pin. Secure the saddle bolt against the material to be bent with a wrench and adequate pressure to insure the material does not pull or slip from the forming die under bending pressure.

With your material secured between the forming die assembly and wiper bar assembly, engage the head-frame with the die set by inserting the 7/8" (long) drive pin through the top inner head-frame, through the forming die "drive hole" and through the bottom inner head-frame. Engage the material with the die set by activating the OUT button on the hand held controller. Advancing the die against the material will extend the hydraulic cylinder and "push" the inner frames of the head-frame away from the outer frames. This initial movement will snug the die and material together eliminating the "slack" in the assembly.

Depress the OUT button again and the material will be drawn through the die assembly.

Depress the OUT button until your desired bend is achieved or you reach the maximum extend of the cylinder ram for the chosen drive hole.

If the desired bend angle is beyond the reach of the initial drive hole, push the IN button to relieve pressure between the forming die, drive pin and head-frame. Once pressure is relieved in the assembly, you will be able to remove the drive pin from the assembly, fully retract the cylinder and set the drive pin in the next adjacent drive hole. Repeat the process, progressively drawing your material through the bender until your desired bend is achieved. Make sure your material is fully supported in the wiper assembly. Failure to support the material by drawing the material beyond the trailing wiper blade may result in damage to the material, machine, die set or operator. When using square dies, do not run your material beyond the center pin.

When your bend is complete, remove your material from the bender by pushing the IN button to extract the drive pin from the head-frame assembly, push the IN button again to return the head-frame to its starting position, relieve the saddle bolt, pull the saddle pin and saddle. Your material should be able to be easily removed or repositioned for further work.

# TROUBLESHOOTING

## **WARNING**

Quality parts are dependent upon conscientious bender setup, bender operation and bender maintenance. Physically review your bender prior to any operation. Confirm all static components are tight in the assembly. Confirm all moving components are free of obstruction. Confirm all bender tooling, forming die and wiper assemblies are seated within the assembly.

<b>Problem</b>	<b>Solution</b>
<b>Bender Inoperable</b>	<p>Check accessory control switch Check bender male 4-pin power cable is connected to female limit switch port. Check hand control Mil Spec male power cable is connected to female Mil Spec control port</p> <p>Note: Auto Cut port will NOT power the bender accessory.</p>
<b>Drive pins tight</b>	<p>Check alignment of head-frame assembly bolts. Loosen head-frame assembly bolts (4). Reset drive pins in head-frame and die assembly. Re-tighten head-frame assembly bolts.</p>
<b>Scratching of material</b>	<p>Check alignment of material to wiper and forming die. Check for matched/proper die set. Check for adequate lubrication. Check surface quality/cleanliness of material.</p>
<b>Rough cylinder operation</b>	<p>Check fluid level of machine. Check hoses for correct installation. Check fuse at transformer box.</p>
<b>Auto-Stop operation</b>	<p>Check tightness of lever. Check for proper plunger/roller.</p>
<b>Material not moving through die set</b>	<p>Check forming die saddle pin, strap and bolt; tighten as necessary.</p>



# IRONWORKERS

1107 SYKES ST., ALBERT LEA, MN 56007 800-373-8206 [WWW.EDWARDSIRONWORKERS.COM](http://WWW.EDWARDSIRONWORKERS.COM)



# 10 TON TUBE | PIPE BENDER

## MAINTENANCE MANUAL



# MAINTENANCE MANUAL TABLE OF CONTENTS

## 1 GENERAL

Operator and Supervisor Information

Signal Word Definition

Signal Word Panel

Maintenance Precautions

## 2 MAINTENANCE SCHEDULE

Daily/Shift Change Visual Observation

General Maintenance - Daily

General Maintenance -Weekly

## OPERATOR AND SUPERVISOR INFORMATION

This is one of four manuals supplied with your machine.

- **Installation Manual**
- **Safety Instructions Manual**
- **Operations Manual**
- **Maintenance Manual**

Each of the four machine manuals describes 'best practices' in handling, installing, operating and maintaining your machine. The contents of each manual is subject to change without notice due to improvements in the machinery or changes in National or International standards.

All rights reserved. Reproduction of this manual in any form, in whole or in part, is not permitted without the written consent of Edwards Manufacturing Company.

Understand the contents of each manual thoroughly. Keep all manuals close to the machine to allow for easy reference when necessary.

Provide operators with sufficient training and education in the basic functions of the machine prior to machine operation.

Do not allow for operation of the machine by unqualified personnel. Edwards Manufacturing Company is not liable for accidents arising from unskilled, untrained operation.

Do not modify or change the machine without written authorization from Edwards Manufacturing Company. Unauthorized modification to a machine may result in serious operator injury, machine damage and will void your machine warranty.

This machine is manufactured for use by able bodied and able minded operators only. Never operate machinery when tired or under the influence of drugs or alcohol.

Do not resell, relocate or export to a destination other than to the original point of sale. Edwards has designed this machine to meet the standards of the original receiving country and is not liable for meeting any governing body or performance standards beyond those of the original receiving country.



## SIGNAL WORD DEFINITION

 **DANGER**

Indicates a hazardous situation that, if not avoided, will result in death or serious injury.

 **WARNING**

Indicates a hazardous situation that, if not avoided, could result in death or serious injury.

 **CAUTION**

Indicates a hazardous situation that, if not avoided, could result in mild or moderate injury.

**NOTICE**

Indicates information considered important, but not hazard related.

## SIGNAL WORD PANEL ON MACHINE

 **DANGER**

Critical machine safety information is identified on signal word labels. Labels are attached adjacent to the potentially hazardous locations of the machine. Reference the Safety Instruction Manual for additional information regarding the potentially hazardous condition identified on the label.

**Review ALL labels on the machinery, reference the operational precautions and safe operations sections within this manual before any operation activity is initiated.**

*Failure to read and understand the signal word labels affixed to the machinery may result in operator death or injury.*

## MAINTENANCE PRECAUTIONS

 **DANGER**

### Electrical Hazard

Dangerous high voltages are present inside the electrical enclosure of this product. Only qualified, authorized, maintenance or service personnel should gain access to the electrical panel.

### Lockout Power

Danger, circuits are live. Lockout / tagout upstream power source before any maintenance activity is performed.

### Shear / Crush Hazard

Moving parts can cut and crush. Keep hands clear when servicing and maintaining the Ironworker.

### Hydraulic Fluid Hazard

Hydraulic hoses are under pressure. Pressurized fluid can pierce skin and cause severe injury. To avoid physical hazard, always wear personal protective equipment when servicing / maintaining the Ironworker.

### Do Not Operate With Guard Removed

Physical barriers and guards have been designed and installed to protect maintenance personnel from moving parts that can pinch, cut and crush. If it is necessary to remove guarding when servicing the Ironworker, immediately replace guards after service and prior to power being restored to the machinery.

### Refer to Manuals

For safe installation, operation and maintenance of the machine, read:

- Installation Manual
- Safety Instructions Manual
- Operations Manual
- Maintenance Manual

### Wear Personal Protective Equipment

To avoid physical hazard wear protective eyewear, clothing, gloves, footwear, head-gear and hearing protection.

 **WARNING:** This product can expose you to chemicals including Methyl Isobutyl Ketone which is known to the State of California to cause cancer and birth defects or other reproductive harm. For more information go to <http://www.p65warnings.ca.gov>.

 **WARNING:** Some dust, fumes and gases created by power sanding, sawing, grinding, drilling, welding and other construction activities contain chemicals known to the State of California to cause cancer and birth defects or other reproductive harm. Some examples of these chemicals are:

- lead from lead based paint
- crystalline silica from bricks, cement and other masonry products
- arsenic and chromium from chemically treated lumber

Your risk of exposure varies, depending on how often you do this type of work. To reduce your exposure to these chemicals, work in a well-ventilated area and work with approved safety equipment, such as dust masks that are specifically designed to filter out microscopic particles. For more information go to <http://www.p65warnings.ca.gov/> and <http://www.p65warnings.ca.gov/wood>.

# MAINTENANCE SCHEDULE

## CAUTION

Your Edwards Tube/Pipe Bender will benefit from reasonable care and periodic maintenance. Reasonable care includes daily visual observation, as well as general maintenance procedures at daily and weekly intervals by operator/maintenance personnel. Perform inspections and maintenance of the electrical, hydraulic, and mechanical systems of the Edwards 10 Ton Tube/Pipe Bender and its connection to the Ironworker or Porta-Power as follows:

### Daily/Shift Change Visual Observation

## CAUTION

#### Electrical System

Visually inspect controls and power cording to the Ironworker or Porta-Power for signs of damage. Cut, abraded or crushed electrical cords may present an electrical hazard to the Operator and/or damage the machinery.

#### Hydraulic System

Visually inspect exposed or surface mounted hydraulic hoses and fittings for signs of damage. Cut, abraded or crushed hydraulic hoses or leaking fittings may present a hydraulic fluid hazard to the Operator and/or damage the machinery.

#### Mechanical System

Visually moving parts, guards and material hold-downs must remain on the machine for safe operation. Clear any material obstructions at the work station prior to visually inspecting moving parts of the machine. Cycle the machine. Machine should operate smoothly in hydraulic extend and retract mode.

Failure of any element of the daily/shift change visual observation will require maintenance of the affected accessory component. Please refer to the following maintenance procedures.

### General Maintenance - Daily

## WARNING

**Disconnect unit from power source.**

*Check bolted connections and secure as necessary.*

*Check bearing surface quality.*

*Visually inspect pipe and tube dies and their respective wiper assemblies for chips or galling in the bearing surface.*

*Verify wiper blades are secure in their mounting block. The wiper blades of your Tube/Pipe Bender are crafted from hardened aluma-bronze. Pipe and tube dies are manufactured from billet steel for enhanced strength and durability. These are wearing parts that will fail over time and will require replacement. Order additional die sets through your Edwards distributor or through Edwards Manufacturing Company. Install replacement parts according to the Operations Manual.*

*Clean your Tube/Pipe Bender daily. Disconnect the unit from its power source first. Do not use liquid cleaners, aerosols, abrasive pads, scouring powders or solvents such as benzene or alcohol. Clean your machine with a brush and soft cloth lightly moistened with a mild, water-based detergent solution. Remove filings, dirt, dust and grime from working surfaces. Ensure the surfaces are fully dry before reconnecting power.*

### General Maintenance - Weekly

## WARNING

**Disconnect unit from power source.**

*Check wiring harness for loose connections or damaged control wiring. Check hydraulic fittings and hoses for wear or damage.*



# IRONWORKERS

1107 SYKES ST., ALBERT LEA, MN 56007 800-373-8206 WWW.EDWARDSIRONWORKERS.COM