



**OMER NORTH AMERICA INC. 2010**

# **O.ME.R SPA - FOUNDED 1978**





# KAR "PANTOGRAPH" VERTICAL PLATFORM LIFTING SYSTEM





# **KAR LIFT SERIES - K200, K300 & K400**

## **KAR LIFT ECL HEAVY SERVICE**

**KAR200 44,000 LB.**  
**KAR250 55,000 LB.**  
**KAR300 66,000 LB.**  
**KAR350 77,000 LB.**  
**KAR400 88,000 LB.**  
**KAR450 99,000 LB**

## **KAR LIFT CLOUD STANDARD SERVICE**

**KAR290 64,000 LB.**  
**KAR230 51,000 LB.**  
**KAR190 42,000 LB.**  
**KAR170 37,000 LB.**  
**KAR140 31,000 LB.**



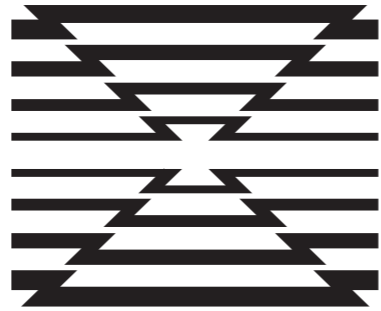

**OMER®**

# **KAR LIFT - 11 LIFTING CAPACITIES 9 RUNWAY LENGTHS**





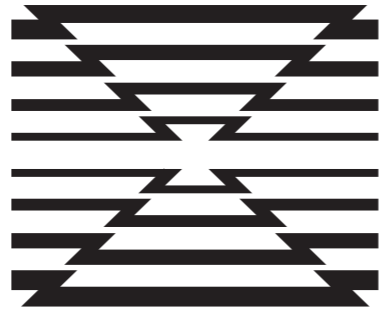

**OMER®**



# **KAR LIFT - REVERSE SCISSOR “PANTOGRAPH”**

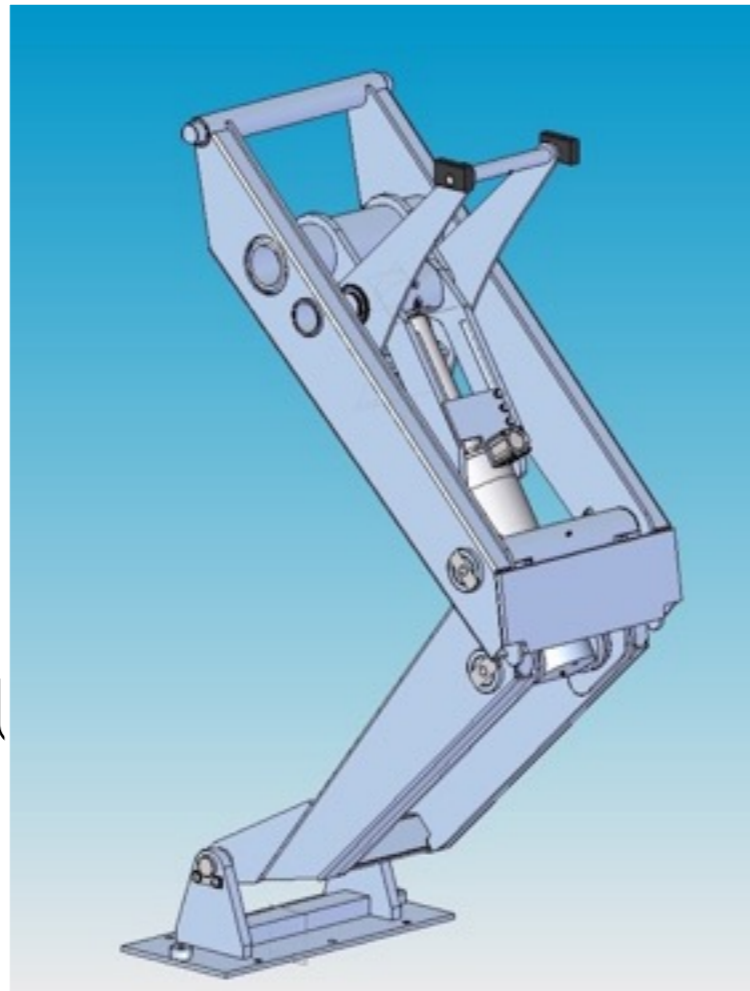

or su

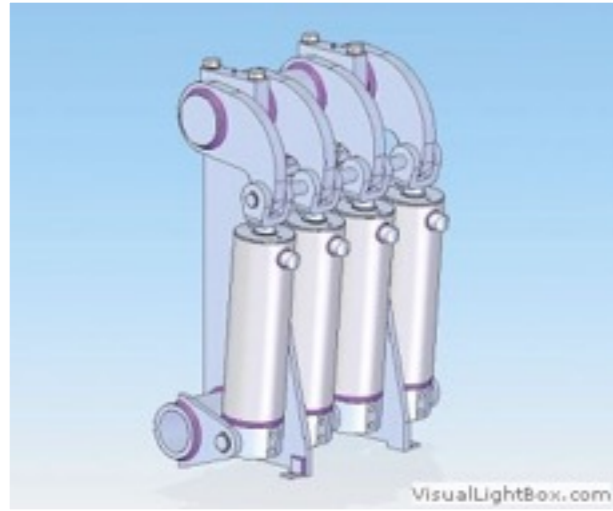

# **KAR LIFT - PATENTED VOLUMETRIC HYDRAULIC MECHANICAL CONTROL**





# **KAR LIFT - PATENTED AOS ENERGY ABSORBING HINGE**







# **KAR LIFT - BOXED STRUCTURE RUNWAYS WITH VERTICAL SUPPORT TUBE**



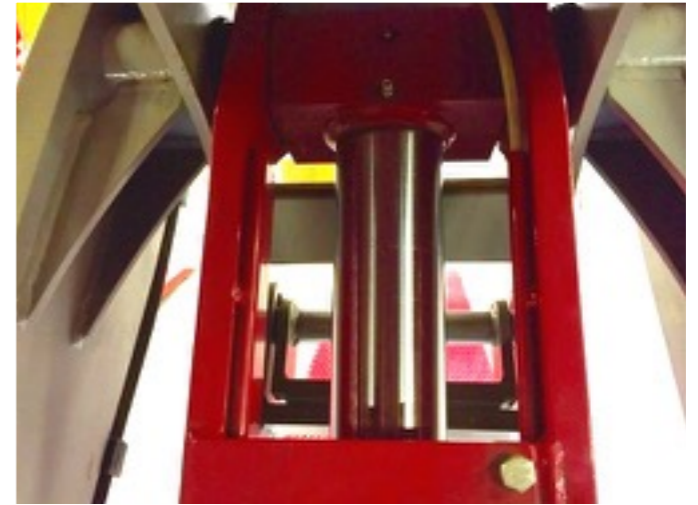

# **KAR LIFT - GREASE FITTINGS AT ALL HINGE POINTS**

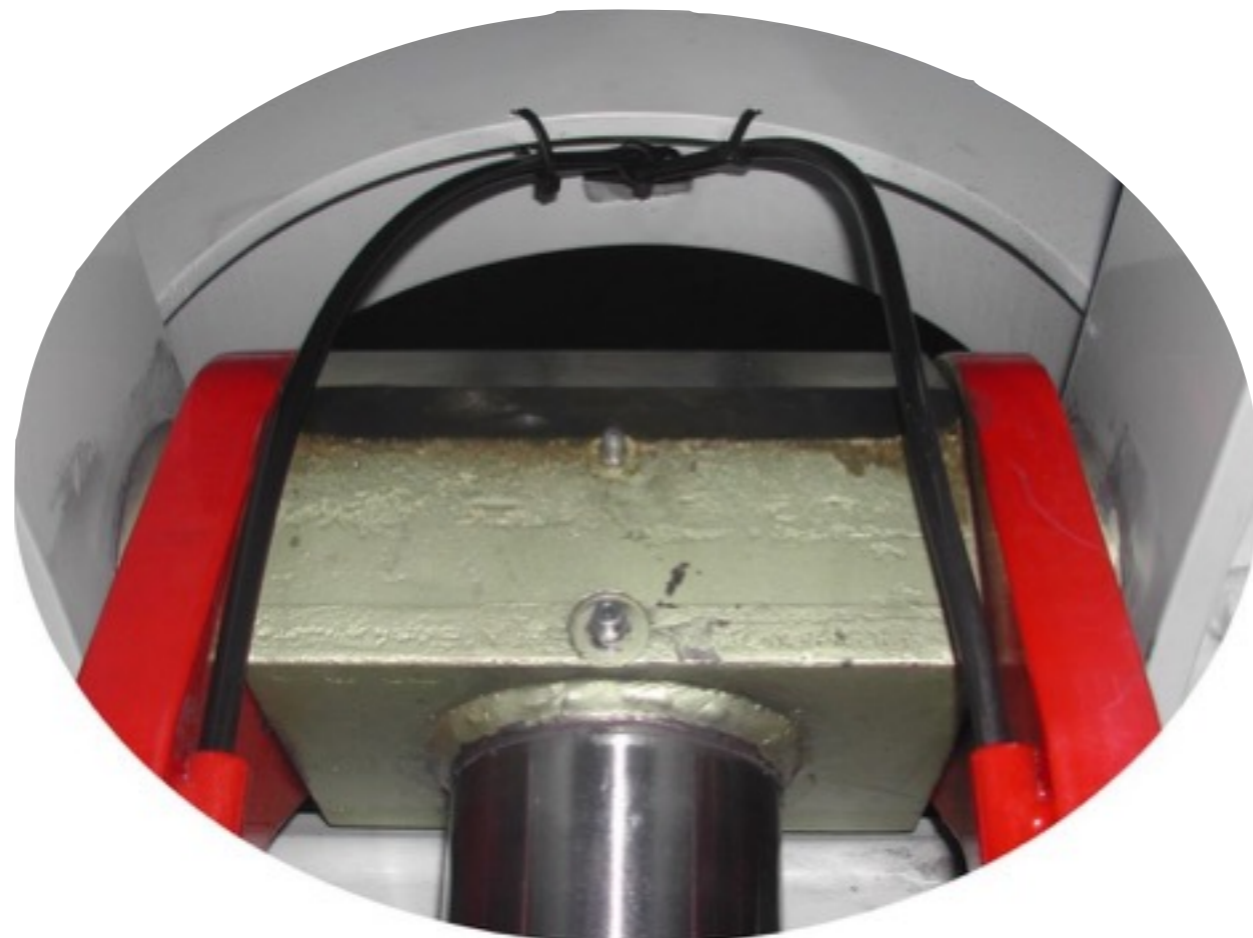



# **KAR LIFT CONTROL - KEY LOCK WITH SECONDARY LOWERING & PANIC STOP**







# **KAR LIFT - CHECKER PLATE FIXED APPROACH RAMPS**





# **KAR LIFT - AIR LOCK RELEASE WITH 16 POSITION LOCKING SYSTEM**



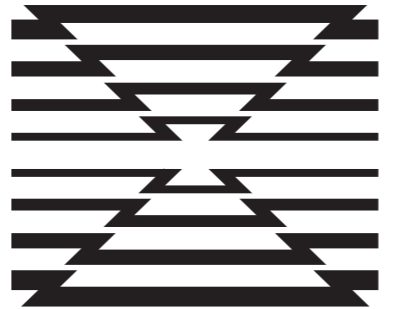

**OMER®**

**WHY BUY AN  
OMER KAR LIFT?**





# NO SLIDING POINTS



## COMPETITOR

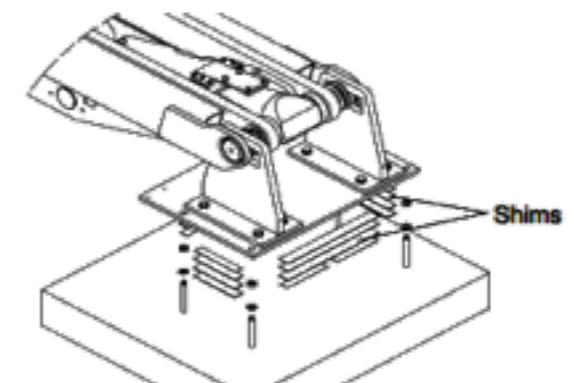



# GREASE FITTINGS ON EVERY HINGE POINT

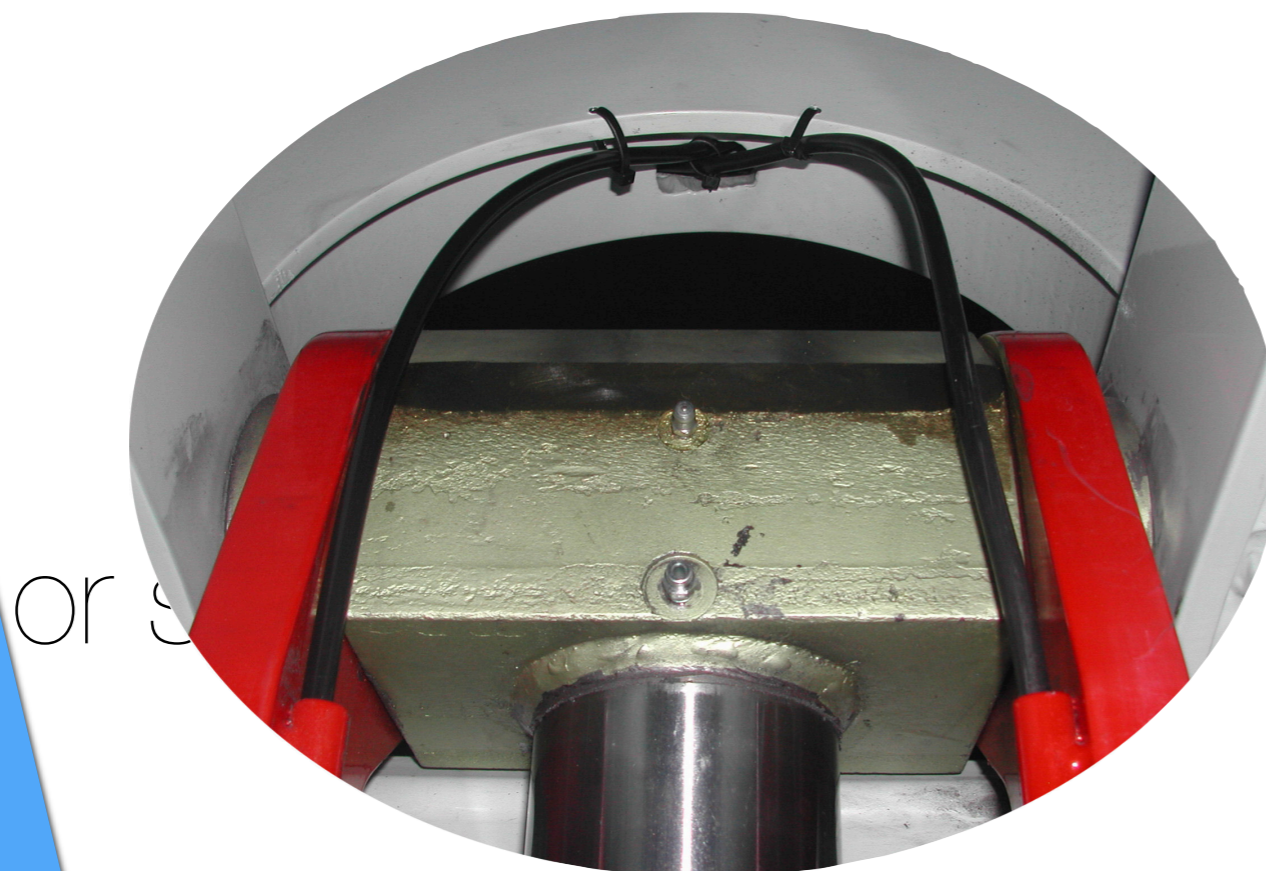

**COMPETTOR**







# BOX DESIGN NON SAG RUNWAYS

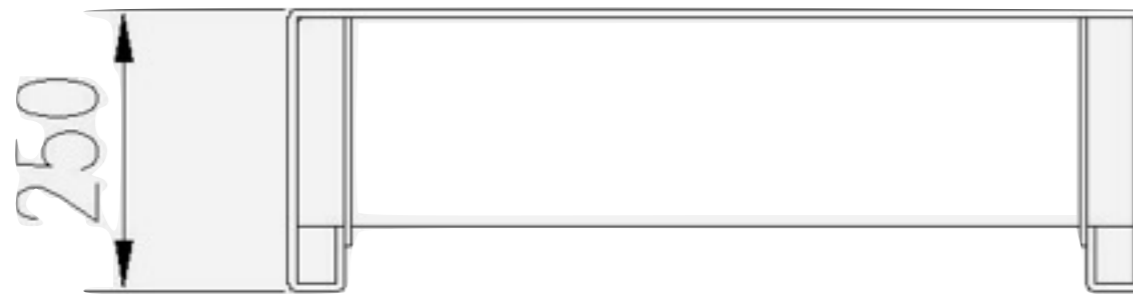

## COMPETTOR





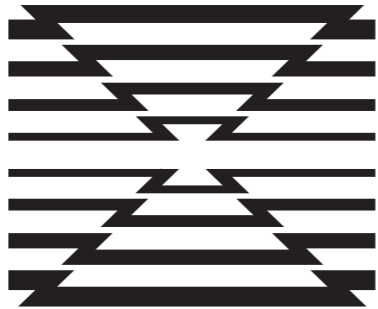

**OMER<sup>®</sup>**

# **PURPOSE BUILT MULTI PIECE “VECTOR” LEGS**



**COMPETTOR**





# NO ELECTRONIC SENSORS ON LIFT - NO FAULT CODES



**COMPETTOR**







**STAYS LEVEL ALL THE TIME**

**40% UNEVEN LOADING**







**KAR LIFT - MORE MODELS,  
MORE CAPACITIES &  
MORE LIFTING APPLICATIONS**

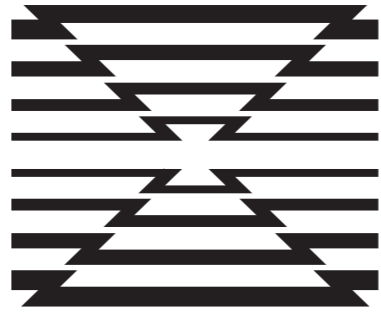

**OMER®**

# **KAR LIFT SURFACE MOUNT DRIVE THROUGH**





# **KAR LIFT SURFACE MOUNT DRIVE ON - BACK OFF**





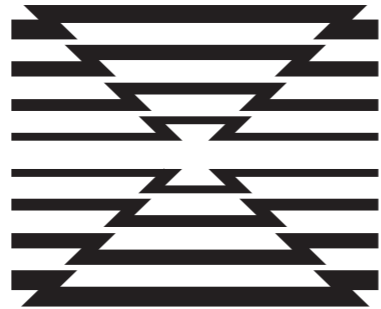

**OMER®**

# **KAR LIFT FLUSH MOUNT DRIVE THROUGH**

**[HTTPS://YOUTU.BE/7LMWHCPKTEC](https://youtu.be/7LMWHCPKTEC)**



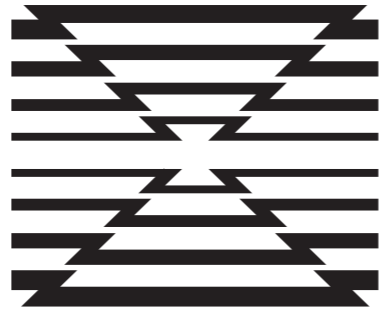

**OMER®**

# **KAR LIFT FLUSH MOUNT DRIVE ON - BACK OFF**



or st





# **KAR LIFT FLUSH MOUNT TWIN TRENCH OR BATH TUBE STYLE**







# KAR LIFT - EXTRA LONG APPLICATIONS





# KAR LIFT - SHORT WHEEL BASE APPLICATIONS







# KAR LIFT - EXTRA HEAVY LOADING APPLICATIONS





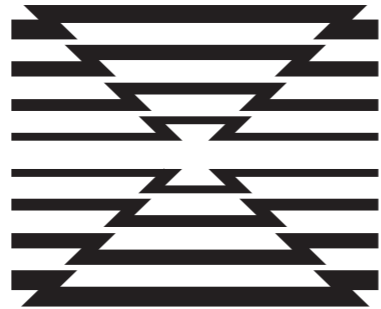

**OMER®**

# **KAR LIFT - ROUGH SERVICE WASH BAY APPLICATIONS**



**STAINLESS STEEL  
CABINET LINES & HARDWARE**

**HOT DIP GALVANIZING  
100% COVERAGE OF ALL  
STRUCTURAL COMPONENTS**



# **KAR LIFT - ROUGH SERVICE WASH BAY APPLICATIONS GALVANIZED & STAINLESS STEEL**







# **KAR LIFT OPTIONS**

## **JACKING BEAM RAIL & LED LIGHTS**

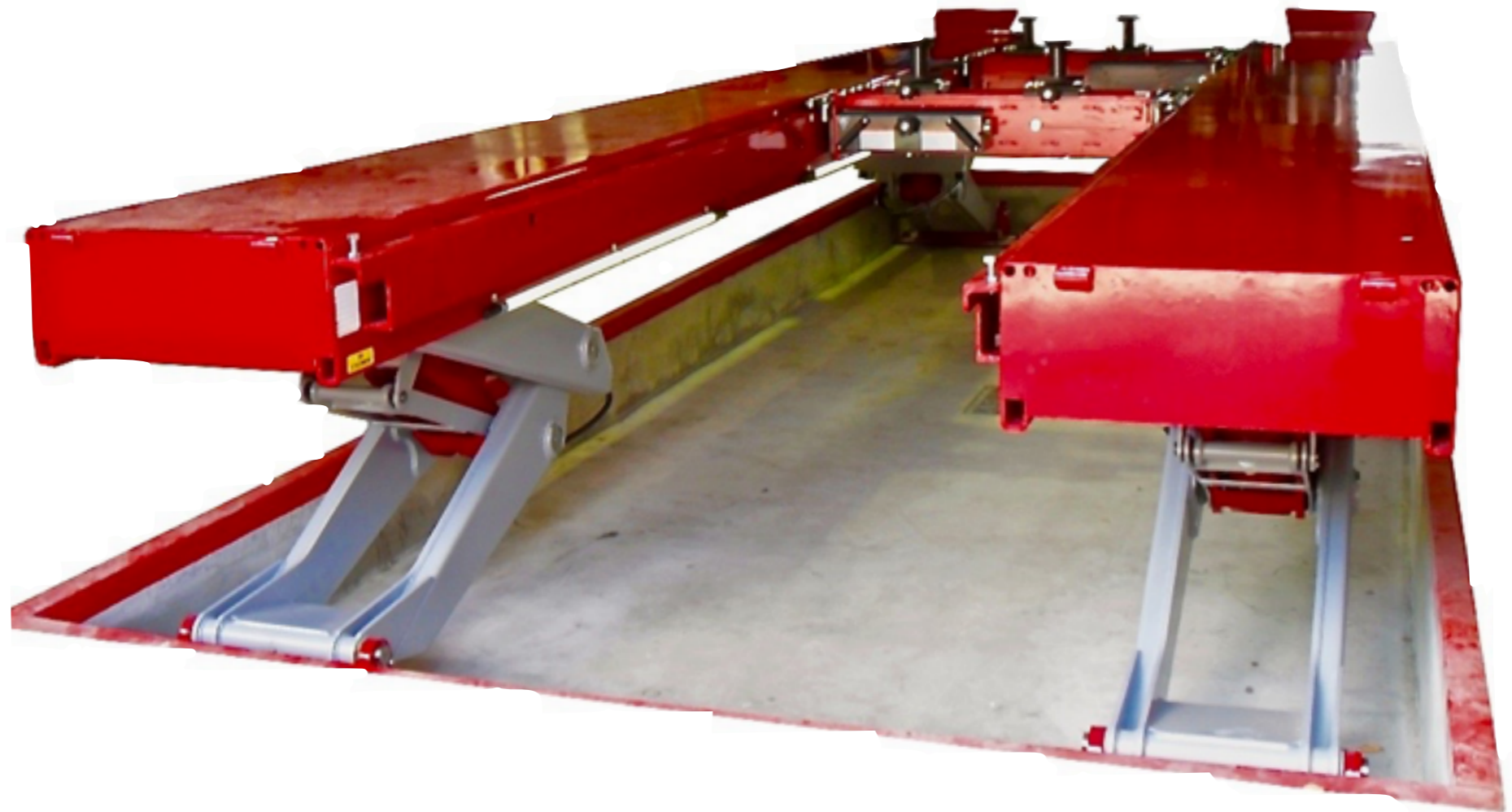





# **KAR LIFT OPTIONS - AIR /HYDRAULIC JACKING BEAM 12 T, 16T & 20 TON CAPACITIES**

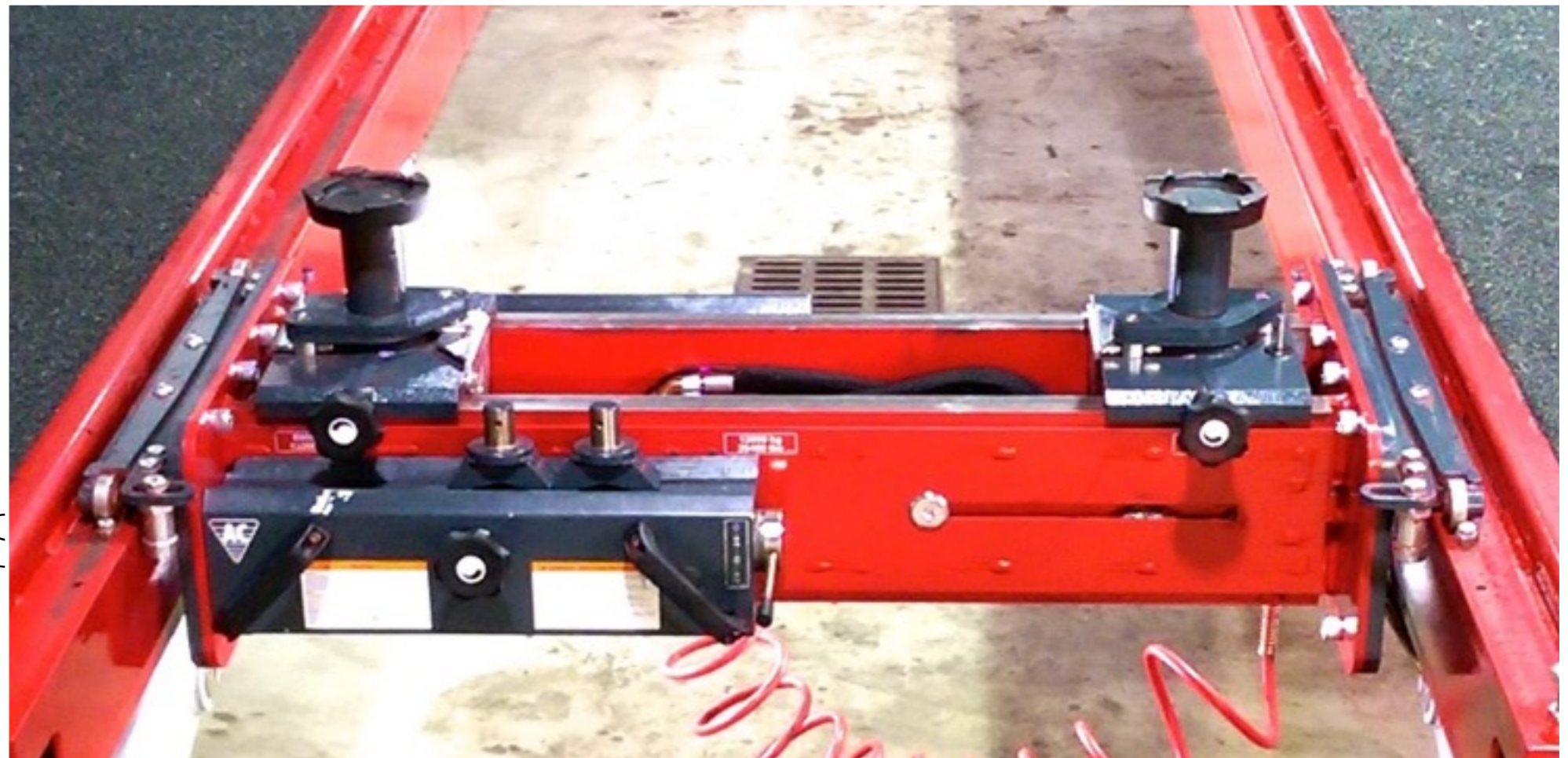

or s

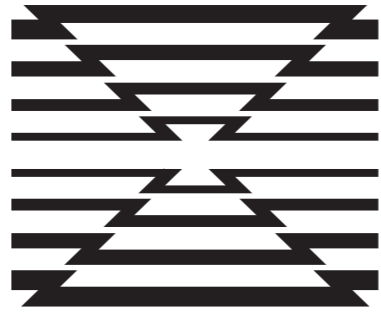

**OMER®**

# **KAR LIFT OPTIONS RUNWAY EXTENSIONS WITH ALIGNMENT RADIUS PLATE POCKETS**







# **KAR LIFT OPTIONS - FLUSH MOUNT RAISED CENTRE PLATFORMS**







# VEGA “PARALLELOGRAM” PLATFORM LIFTING SYSTEM





# **VEGA LIFT SERIES - VEGA 240, 340 & 450**

**VEGA 240 55,000 LB.**

**VEGA 350 75,000 LB.**

**VEGA 450 99,000 LB.**

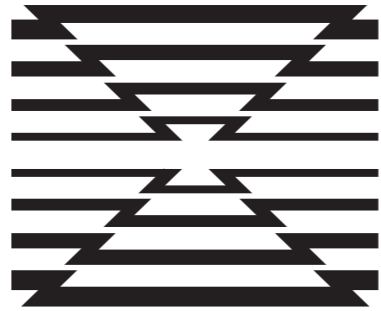

**OMER®**

# **VEGA - 3 LIFTING CAPACITIES 6 RUNWAY LENGTHS**





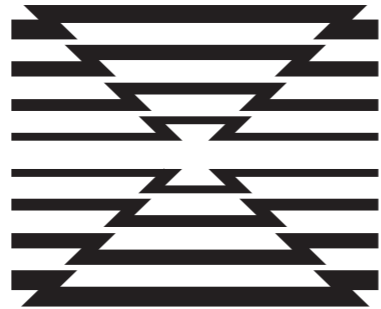

**OMER®**

# **VEGA - OPEN FLOOR OR FULL BASE FRAME DESIGN**





# VEGA - RUNWAY LIGHTING & AUTOMATIC FOOT SHUTOFF BARS







# VEGA - FLUSH OR SURFACE MOUNTED



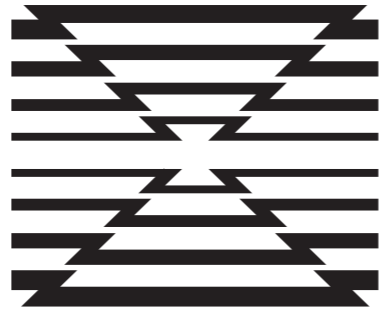

**OMER®**

# **VEGA - ROUGH SERVICE WASH BAY GALVANIZED**

