

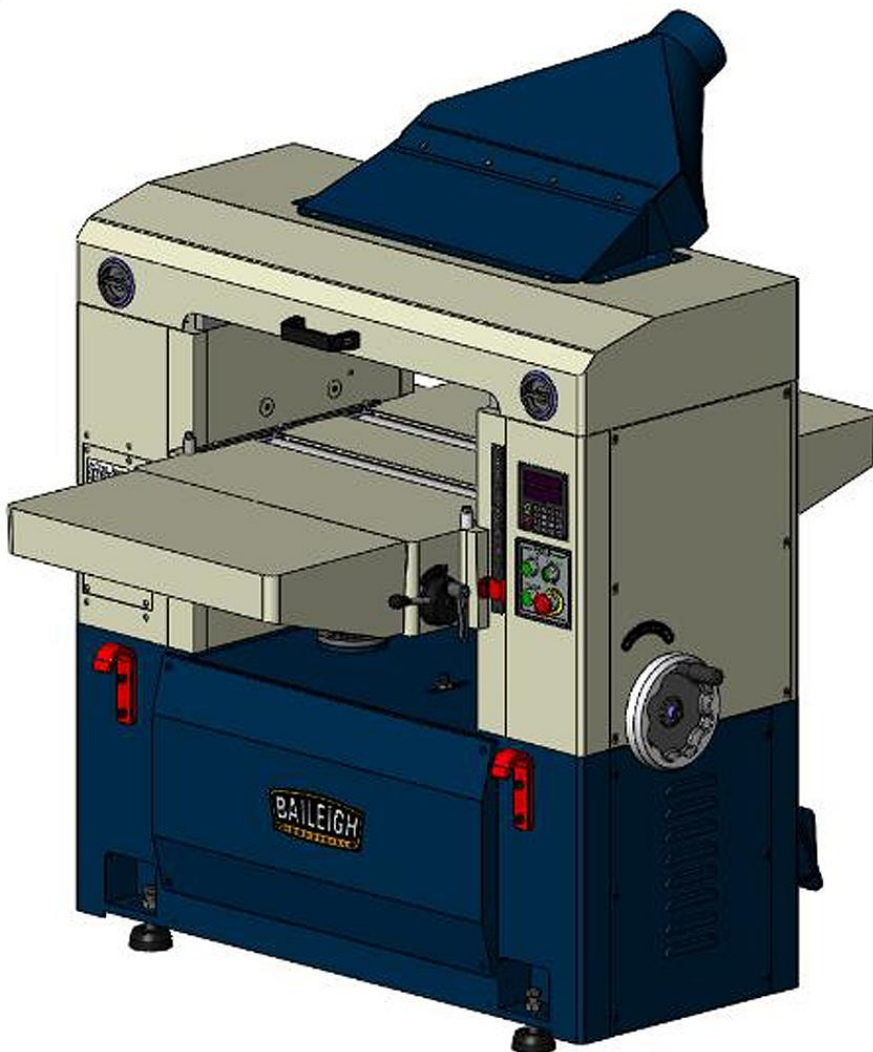

OPERATOR'S MANUAL

Wood Working



PLANER MODEL: IP-2509-HD-3

Baileigh Industrial, Inc.
P.O. Box 531
Manitowoc, WI 54221-0531
Phone: 920.684.4990
Fax: 920.684.3944
sales@baileigh.com

REPRODUCTION OF THIS MANUAL IN ANY FORM WITHOUT WRITTEN APPROVAL OF BAILEIGH INDUSTRIAL, INC. IS PROHIBITED. Baileigh Industrial, Inc. does not assume and hereby disclaims any liability for any damage or loss caused by an omission or error in this Operator's Manual, resulting from accident, negligence, or other occurrence.

Table of Contents

THANK YOU & WARRANTY	1
INTRODUCTION.....	3
GENERAL NOTES.....	3
SAFETY INSTRUCTIONS	4
SAFETY PRECAUTIONS	7
Dear Valued Customer:.....	7
TECHNICAL SPECIFICATIONS	10
TECHNICAL SUPPORT	10
UNPACKING AND CHECKING CONTENTS.....	11
Cleaning	11
TRANSPORTING AND LIFTING	12
INSTALLATION.....	13
Base Levelling	14
ASSEMBLY.....	15
Extension Table.....	15
Dust Chute Assembly	15
ELECTRICAL.....	16
Connecting Power Supply	17
CONTROLS IDENTIFICATION.....	19
INTERNAL COMPONENT IDENTIFICATION.....	20
OPERATING CONTROLLER	21
Operation Modes.....	22
MANUAL MODE.....	22
SINGLE MODE.....	23
FAST PROGRAM (10 SETS)	25
SELECT COUNTING DIRECTION.....	27
SELECT POSITIONING MODE	28
SET SOFTWARE LIMIT (HI/LO END).....	28
SET TOLERANCES	28
SET LOW SPEED LIMIT	29
SET LINEAR CORRECTION.....	30
CHECK SOFTWARE VERSION.....	30
LOAD DATUM VALUES	31
CONVERSION - IN/MM.....	32
SET DEVICE RESOLUTION	32
CALIBRATION.....	33
CONTROLLER SPECIFICATIONS	33
PARAMETER	34
ENTER PARAMETER SETTINGS MODE	34
CONTROLLER TROUBLESHOOTING	35
RAISING AND LOWERING TABLE	37
ADJUSTING THICKNESS SCALE.....	37
TABLE ROLLER ADJUSTMENT	37
CHANGING FEED RATE.....	38
TABLE STOP.....	38
OPENING HOOD.....	38
SETUP OF FEED ROLLERS, CHIP BREAKER AND PRESSURE BAR.....	39

ANTI-KICKBACK FINGERS.....	41
IN-FEED ROLLER ADJUSTMENT	41
CHIPBREAKER ADJUSTMENT	42
PRESSURE BAR ADJUSTMENT	43
OUT-FEED ROLLERS ADJUSTMENT	44
V-BELT ADJUSTMENT	45
TABLE GIBS ADJUSTMENT	45
TABLE ADJUSTMENTS	46
TABLE ROLLERS ADJUSTMENT	47
REPLACING OR ROTATING KNIFE INSERTS	48
BASIC OPERATION	49
Operation Tips	50
CUT TROUBLESHOOTING.....	50
Feed Restriction	51
Clip Marks	51
Chatter	51
Snipe.....	52
Tapers.....	52
Twisting	52
Halted Feeding	52
MAINTENANCE	53
LUBRICATION.....	54
TROUBLESHOOTING: PLANER OPERATING.....	55
TROUBLESHOOTING: MECHANICAL AND ELECTRICAL	56
ELECTRICAL SCHEMATIC.....	58
PARTS DIAGRAM	59
Parts List	66



THANK YOU & WARRANTY

Thank you for your purchase of a machine from Baileigh Industrial. We hope that you find it productive and useful to you for a long time to come.

Inspection & Acceptance. Buyer shall inspect all Goods within ten (10) days after receipt thereof. Buyer's payment shall constitute final acceptance of the Goods and shall act as a waiver of the Buyer's rights to inspect or reject the goods unless otherwise agreed. If Buyer rejects any merchandise, Buyer must first obtain a Returned Goods Authorization ("RGA") number before returning any goods to Seller. Goods returned without a RGA will be refused. Seller will not be responsible for any freight costs, damages to goods, or any other costs or liabilities pertaining to goods returned without a RGA. Seller shall have the right to substitute a conforming tender. Buyer will be responsible for all freight costs to and from Buyer and repackaging costs, if any, if Buyer refuses to accept shipment. If Goods are returned in unsalable condition, Buyer shall be responsible for full value of the Goods. Buyer may not return any special order Goods. Any Goods returned hereunder shall be subject to a restocking fee equal to 30% of the invoice price.

Specifications. Seller may, at its option, make changes in the designs, specifications or components of the Goods to improve the safety of such Goods, or if in Seller's judgment, such changes will be beneficial to their operation or use. Buyer may not make any changes in the specifications for the Goods unless Seller approves of such changes in writing, in which event Seller may impose additional charges to implement such changes.

Limited Warranty. Seller warrants to the original end-user that the Goods manufactured or provided by Seller under this Agreement shall be free of defects in material or workmanship for a period of twelve (12) months from the date of purchase, provided that the Goods are installed, used, and maintained in accordance with any instruction manual or technical guidelines provided by the Seller or supplied with the Goods, if applicable. The original end-user must give written notice to Seller of any suspected defect in the Goods prior to the expiration of the warranty period. The original end-user must also obtain a RGA from Seller prior to returning any Goods to Seller for warranty service under this paragraph. Seller will not accept any responsibility for Goods returned without a RGA. The original end-user shall be responsible for all costs and expenses associated with returning the Goods to Seller for warranty service. In the event of a defect, Seller, at its sole option, shall repair or replace the defective Goods or refund to the original end-user the purchase price for such defective Goods. Goods are not eligible for replacement or return after a period of 30 days from date of receipt. The foregoing warranty is Seller's sole obligation, and the original end-user's exclusive remedy, with regard to any defective Goods. This limited warranty does not apply to: (a) die sets, tooling, and saw blades; (b) periodic or routine maintenance and setup, (c) repair or replacement of the Goods due to normal wear and tear, (d) defects or damage to the Goods resulting from misuse, abuse, neglect, or accidents, (e) defects or damage to the Goods resulting from improper or unauthorized alterations, modifications, or changes; and (f) any Goods that has not been installed and/or maintained in accordance with the instruction manual or technical guidelines provided by Seller.

EXCLUSION OF OTHER WARRANTIES. THE FOREGOING LIMITED WARRANTY IS IN LIEU OF ALL OTHER WARRANTIES, EXPRESS OR IMPLIED. ANY AND ALL OTHER EXPRESS, STATUTORY OR IMPLIED WARRANTIES, INCLUDING BUT NOT LIMITED TO, ANY WARRANTY OF MERCHANTABILITY OR FITNESS FOR ANY PARTICULAR PURPOSE ARE EXPRESSLY DISCLAIMED. NO WARRANTY IS MADE WHICH EXTENDS BEYOND THAT WHICH IS EXPRESSLY CONTAINED HEREIN.

Limitation of Liability. IN NO EVENT SHALL SELLER BE LIABLE TO BUYER OR ANY OTHER PARTY FOR ANY INCIDENTAL, CONSEQUENTIAL OR SPECIAL DAMAGES (INCLUDING, WITHOUT LIMITATION, LOST PROFITS OR DOWN TIME) ARISING FROM OR IN MANNER CONNECTED WITH THE GOODS, ANY BREACH BY SELLER OR ITS AGENTS OF THIS AGREEMENT, OR ANY OTHER CAUSE WHATSOEVER, WHETHER BASED ON CONTRACT, TORT OR ANY OTHER THEORY OF LIABILITY. BUYER'S REMEDY WITH RESPECT TO ANY CLAIM ARISING UNDER THIS AGREEMENT IS STRICTLY LIMITED TO NO MORE THAN THE AMOUNT PAID BY THE BUYER FOR THE GOODS.



Force Majeure. Seller shall not be responsible for any delay in the delivery of, or failure to deliver, Goods due to causes beyond Seller's reasonable control including, without limitation, acts of God, acts of war or terrorism, enemy actions, hostilities, strikes, labor difficulties, embargoes, non-delivery or late delivery of materials, parts and equipment or transportation delays not caused by the fault of Seller, delays caused by civil authorities, governmental regulations or orders, fire, lightening, natural disasters or any other cause beyond Seller's reasonable control. In the event of any such delay, performance will be postponed by such length of time as may be reasonably necessary to compensate for the delay.

Installation. If Buyer purchases any Goods that require installation, Buyer shall, at its expense, make all arrangements and connections necessary to install and operate the Goods. Buyer shall install the Goods in accordance with any Seller instructions and shall indemnify Seller against any and all damages, demands, suits, causes of action, claims and expenses (including actual attorneys' fees and costs) arising directly or indirectly out of Buyer's failure to properly install the Goods.

Work By Others; Safety Devices. Unless agreed to in writing by Seller, Seller has no responsibility for labor or work performed by Buyer or others, of any nature, relating to design, manufacture, fabrication, use, installation or provision of Goods. Buyer is solely responsible for furnishing, and requiring its employees and customers to use all safety devices, guards and safe operating procedures required by law and/or as set forth in manuals and instruction sheets furnished by Seller. Buyer is responsible for consulting all operator's manuals, ANSI or comparable safety standards, OSHA regulations and other sources of safety standards and regulations applicable to the use and operation of the Goods.

Remedies. Each of the rights and remedies of Seller under this Agreement is cumulative and in addition to any other or further remedies provided under this Agreement or at law or equity.

Attorney's Fees. In the event legal action is necessary to recover monies due from Buyer or to enforce any provision of this Agreement, Buyer shall be liable to Seller for all costs and expenses associated therewith, including Seller's actual attorneys' fees and costs.

Governing Law/Venue. This Agreement shall be construed and governed under the laws of the State of Wisconsin, without application of conflict of law principles. Each party agrees that all actions or proceedings arising out of or in connection with this Agreement shall be commenced, tried, and litigated only in the state courts sitting in Manitowoc County, Wisconsin or the U.S. Federal Court for the Eastern District of Wisconsin. Each party waives any right it may have to assert the doctrine of "forum non conveniens" or to object to venue to the extent that any proceeding is brought in accordance with this section. Each party consents to and waives any objection to the exercise of personal jurisdiction over it by courts described in this section. Each party waives to the fullest extent permitted by applicable law the right to a trial by jury.

Summary of Return Policy.

- 10 Day acceptance period from date of delivery. Damage claims and order discrepancies will not be accepted after this time.
- You must obtain a Baileigh issued RGA number PRIOR to returning any materials.
- Returned materials must be received at Baileigh in new condition and in original packaging.
- Altered items are not eligible for return.
- Buyer is responsible for all shipping charges.
- A 30% re-stocking fee applies to all returns.

Baileigh Industrial makes every effort to ensure that our posted specifications, images, pricing and product availability are as correct and timely as possible. We apologize for any discrepancies that may occur. Baileigh Industrial reserves the right to make any and all changes deemed necessary in the course of business including but not limited to pricing, product specifications, quantities, and product availability.

For Customer Service & Technical Support:

Please contact one of our knowledgeable Sales and Service team members at: (920) 684-4990 or e-mail us at sales@baileighindustrial.com



INTRODUCTION

The quality and reliability of the components assembled on a Baileigh Industrial machine guarantee near perfect functioning, free from problems, even under the most demanding working conditions. However if a situation arises, refer to the manual first. If a solution cannot be found, contact the distributor where you purchased our product. Make sure you have the serial number and production year of the machine (stamped on the nameplate). For replacement parts refer to the assembly numbers on the parts list drawings.

Our technical staff will do their best to help you get your machine back in working order.

In this manual you will find: (when applicable)

- Safety procedures
- Correct installation guidelines
- Description of the functional parts of the machine
- Capacity charts
- Set-up and start-up instructions
- Machine operation
- Scheduled maintenance
- Parts lists

GENERAL NOTES

After receiving your equipment remove the protective container. Do a complete visual inspection, and if damage is noted, **photograph it for insurance claims** and contact your carrier at once, requesting inspection. Also contact Baileigh Industrial and inform them of the unexpected occurrence. Temporarily suspend installation.

Take necessary precautions while loading / unloading or moving the machine to avoid any injuries.

Your machine is designed and manufactured to work smoothly and efficiently. Following proper maintenance instructions will help ensure this. Try and use original spare parts, whenever possible, and most importantly; **DO NOT** overload the machine or make any unauthorized modifications.



Note: *This symbol refers to useful information throughout the manual.*



IMPORTANT

PLEASE READ THIS OPERATORS MANUAL CAREFULLY

It contains important safety information, instructions, and necessary operating procedures. The continual observance of these procedures will help increase your production and extend the life of the equipment.

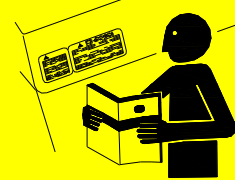

SAFETY INSTRUCTIONS

LEARN TO RECOGNIZE SAFETY INFORMATION

This is the safety alert symbol. When you see this symbol on your machine or in this manual, **BE ALERT TO THE POTENTIAL FOR PERSONAL INJURY!**

Follow recommended precautions and safe operating practices.

UNDERSTAND SIGNAL WORDS

A signal word – **DANGER**, **WARNING**, or **CAUTION** is used with the safety alert symbol. **DANGER** identifies a hazard or unsafe practice that will result in severe **Injury or Death**.

Safety signs with signal word **DANGER** or **WARNING** are typically near specific hazards.

General precautions are listed on **CAUTION** safety signs. **CAUTION** also calls attention to safety messages in this manual.



DANGER



WARNING



CAUTION



SAVE THESE INSTRUCTIONS.
Refer to them often and use them to instruct others.



PROTECT EYES

Wear safety glasses or suitable eye protection when working on or around machinery.

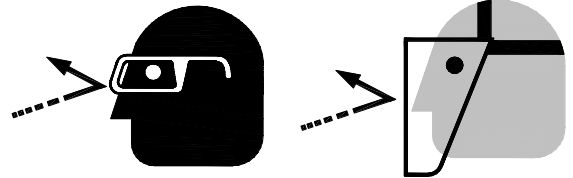

PROTECT AGAINST NOISE

Prolonged exposure to loud noise can cause impairment or loss of hearing. Wear suitable hearing protective devices such as ear muffs or earplugs to protect against objectionable or uncomfortable loud noises.

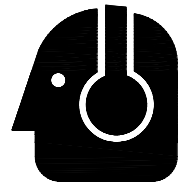

BEWARE OF PINCH POINTS

Keep hands and fingers clear of all potential pinch points. These include sprockets and chains along with belts and pulleys.

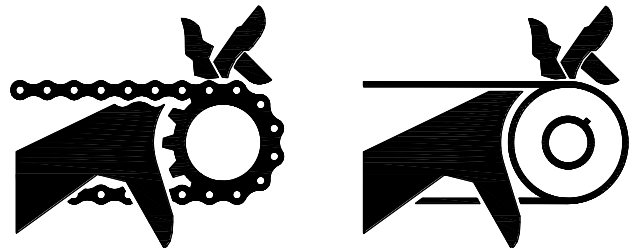

DUST HAZARD

Wear appropriate dust mask. Dust created while using machinery can cause cancer, birth defects, and long term respiratory damage. Be aware of the dust hazards associated with all types of materials.

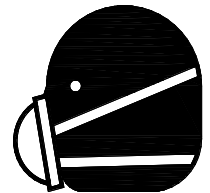

DUST PARTICLES AND IGNITION SOURCES

DO NOT operate the table saw in areas where explosion risks are high. Such areas include locations near pilot lights, open flames, or other ignition sources.

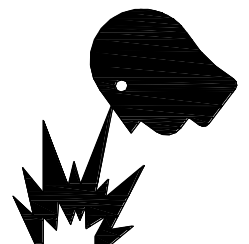



CUTTER HAZARD

Keep hands and fingers away from the rotating cutter blades. These rotating cutters can be extremely dangerous if you do not follow proper safety procedures. **NEVER place hands directly over or in front of the cutter. Keep hand at least 6" (150mm) from the cutter while operating.**



ENTANGLEMENT HAZARD – ROTATING BLADES

Contain long hair, **DO NOT** wear jewelry or loose fitting clothing.

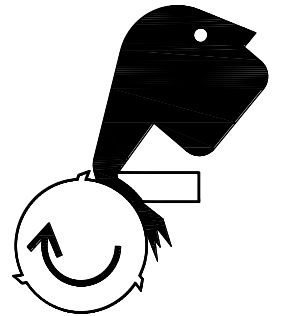

HIGH VOLTAGE

USE CAUTION IN HIGH VOLTAGE AREAS. DO NOT assume the power to be off.
FOLLOW PROPER LOCKOUT PROCEDURES.

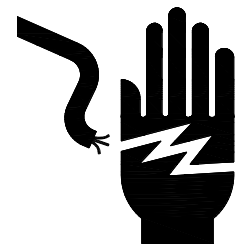

EMERGENCY STOP BUTTON

In the event of incorrect operation or dangerous conditions, the machine can be stopped immediately by pressing the **E-STOP** button. Twist the emergency stop button clockwise (cw) to reset.
Note: Resetting the E-Stop will not start the machine.





SAFETY PRECAUTIONS



Wood working can be dangerous if safe and proper operating procedures are not followed. As with all machinery, there are certain hazards involved with the operation of the product. Using the machine with respect and caution will considerably lessen the possibility of personal injury. However, if normal safety precautions are overlooked or ignored, personal injury to the operator may result.

Safety equipment such as guards, push sticks, hold-downs, feather boards, goggles, dust masks and hearing protection can reduce your potential for injury. But even the best guard won't make up for poor judgment, carelessness or inattention. **Always use common sense** and exercise **caution** in the workshop. If a procedure feels dangerous, don't try it.

REMEMBER: Your personal safety is your responsibility.



WARNING: FAILURE TO FOLLOW THESE RULES MAY RESULT IN SERIOUS PERSONAL INJURY

Dear Valued Customer:

- All Baileigh woodworking machines should be used only for their intended use.
- Baileigh does not recommend or endorse making any modifications or alterations to a Baileigh machine. Modifications or alterations to a machine may pose a substantial risk of injury to the operator or others and may do substantial damage to the machine.
- Any modifications or alterations to a Baileigh machine will invalidate the machine's warranty.

Please enjoy your Baileigh machine!Please enjoy it SAFELY!

1. **FOR YOUR OWN SAFETY, READ INSTRUCTION MANUAL BEFORE OPERATING THE MACHINE.** Learn the machine's application and limitations as well as the specific hazards.
2. **Only trained and qualified personnel should operate this machine.**
3. **Kickback.** Become familiar with the term "**Kickback**" and how it occurs before operating this planer. Kickback happens when the piece part is thrown towards the operator at a high rate of speed with the potential for serious injury.
4. **Kickback Zone.** The path directly behind the end of the in-feed table is referred to as the "Kickback zone". **NEVER** stand or allow others to stand in this area while the machine is running. Position yourself to one side of the machine while the planer is running.
5. **Reaching Inside Planer.** To avoid serious personal injury from rotating knives, NEVER remove guards or reach inside the planer while it is connected to power. Always Follow proper lockout /tagout procedures.



6. **Clearing Jams.** To avoid serious personal injury from rotating knives, ALWAYS STOP the planer and disconnect power before removing a jammed piece part. Always follow proper lockout/tagout procedures.
7. **Using Quality Stock.** Inspect the stock over carefully that you intend to plane. **NEVER** plane a board that has loose knots, staples, or nails in it. **DO NOT** plane a piece of stock if you have any doubts about its structural integrity.
8. **Remove any adjusting tools.** Before operating the machine, make sure any adjusting tools have been removed.
9. **Dull / Damaged Knives.** Use only sharp, undamaged knives to avoid unnecessary kickback of the piece part. Dull and damaged knives will also affect cut quality.
10. **Looking Inside Planer.** Wood chips fly around inside the planer at a high rate of speed as it is running. To avoid possible injury from flying debris, **DO NOT** look inside the planer while it is running.
11. **Keep work area clean.** Cluttered areas invite injuries.
12. **Overloading machine.** By overloading the machine you may cause injury from flying parts. **DO NOT** exceed the specified machine capacities.
13. **Dress appropriate.** **DO NOT** wear loose fitting clothing or jewelry as they can be caught in moving machine parts. Protective clothing and steel toe shoes are recommended when using machinery. Wear a restrictive hair covering to contain long hair.
14. **Use eye and ear protection.** Always wear ISO approved impact safety goggles
15. **Do not overreach.** Maintain proper footing and balance at all times. **DO NOT** reach over or across a running machine.
16. **Stay alert.** Watch what you are doing and use common sense. **DO NOT** operate any tool or machine when you are tired.
17. **Grain Direction.** There is an increased chance of kickback when planing end grain or against the grain. This could also produce chatter and excessive chip out of the material.
18. **Observe work area conditions.** **DO NOT** use machines or power tools in damp or wet locations. Do not expose to rain. Keep work area well lighted. **DO NOT** use electrically powered tools in the presence of flammable gases or liquids.
19. **DO NOT** bypass or defeat any safety interlock systems.
20. Know the location of the **ON - OFF** switch and the "E" - **STOP** button.
21. Keep visitors a safe distance from the work area.
22. **In-feed Roller Clearance.** The in-feed roller is designed to pull material into the rotating cutterhead. To avoid serious personal injury, keep hands, jewelry, clothing, and long hair away from the in-feed roller while operating the machine.
23. **Keep children away.** Children must never be allowed in the work area. **DO NOT** let them handle machines, tools, or extension cords.



24. **DO NOT operate machine if under the influence of alcohol or drugs.** Read warning labels on prescriptions. If there is any doubt, **DO NOT** operate the machine.
25. **DO NOT** touch live electrical components or parts.
26. **Be Sure** all equipment is properly installed and grounded according to national, state, and local codes. If machine is equipped with a three-prong plug, it should be plugged into a three-hole electrical receptacle. If an adapter is used to accommodate a two-prong receptacle, the adapter plug must be attached to a known ground. Never remove the third prong.
27. Inspect power and control cables periodically. Replace if damaged or bare wires are exposed. **Bare wiring can kill!**
28. **Maintain machine in top condition.** Keep clean for best and safest performance. Follow instructions for lubricating and changing accessories.
29. **Reduce the risk of unintentional starting.** Make sure switch is in “**OFF**” position before plugging in power cord.
30. **Never leave machine running unattended. TURN POWER OFF.** Don't leave machine until it comes to a complete stop.
31. **Make sure machine is disconnected from power supply** while motor is being mounted, connected or reconnected.
32. **Using Correct Materials.** Planing materials other than natural wood fiber can result in serious personal injury and machine damage. **NEVER** use this machine for anything except planing in wood.
33. **Warning:** The dust generated by certain woods and wood products can be injurious to your health. Always operate machinery in well-ventilated areas and provide for proper dust removal. Use wood dust collection systems whenever possible.



TECHNICAL SPECIFICATIONS

Cutting Capacity (W x H)	25" x 9" (635 x 229mm)
Table Size	25" x 32" (635 x 813mm)
Extension Wings Size	12.5" (317.5mm)
Table Size with Wings installed	25" x 57" (635 x 1448mm)
Dust Port	5" (127mm)
Maximum Depth of Cut @ 50% Width	1/4" (6.3mm) @ 10ft/min. (3m/min.)
Maximum Depth of Cut @ 100% Width	1/8" (3.1mm) @ 10ft/min. (3m/min.)
Minimum Material Thickness	1/2" (12.7mm)
Minimum Material Length	10" (254mm)
Feed Rate	Variable 10-30ft/min. (3-16m/min.)
Cutterhead Speed	5000 RPM
Number Of Knives	5 rows @ 29 = 145
Cutter Head Size	3-3/8" (85.7mm)
Power Supply	220VAC, 3ph, 60hz
Main Motor	15Hp (11kw), 3Ph, 60Hz, 220VAC, 37A
Infeed Motor	1/2Hp (370w), 3Ph, 60Hz, 220VAC, 2A
Table Height Motor	3/4Hp (560w), 90VDC, 3A
Shipping Weight (Approx.)	1848 lbs. (839kg)

TECHNICAL SUPPORT

Our technical support department can be reached at 920.684.4990, and asking for the support desk for purchased machines. Tech Support handles questions on machine setup, schematics, warranty issues, and individual parts needs: (other than die sets and blades).

For specific application needs or future machine purchases contact the Sales Department at: sales@baileigh.com, Phone: 920.684.4990, or Fax: 920.684.3944.



Note: *The photos and illustrations used in this manual are representative only and may not depict the actual color, labeling or accessories and may be intended to illustrate technique only.*



Note: *The specifications and dimensions presented here are subject to change without prior notice due to improvements of our products.*



UNPACKING AND CHECKING CONTENTS

Your Baileigh machine is shipped complete. Separate all parts from the packing material and check each item carefully. Make certain all items are accounted for before discarding any packing material.

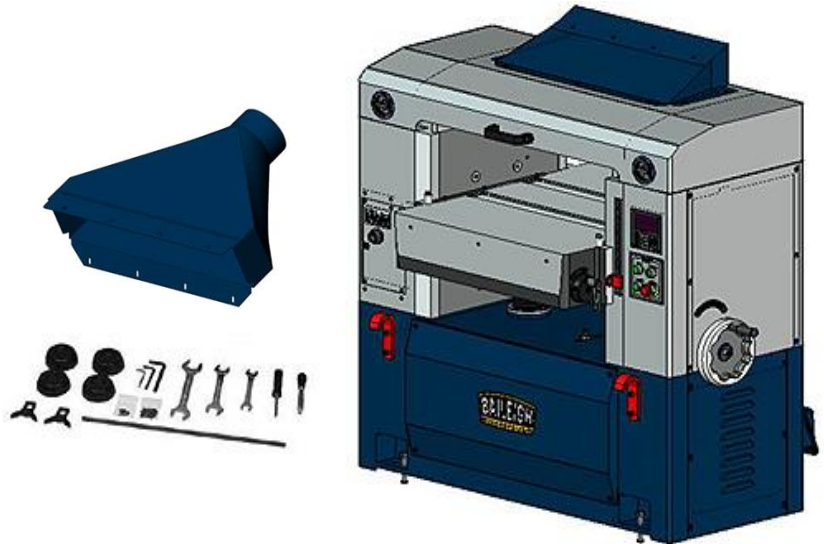

⚠ WARNING: SUFFOCATION HAZARD! Immediately discard any plastic bags and packing materials to eliminate choking and suffocation hazards to children and animals.
If any parts are missing, **DO NOT** place the machine into service until the missing parts are obtained and installed correctly.

Cleaning

⚠ WARNING: DO NOT USE gasoline or other petroleum products to clean the machine. They have low flash points and can explode or cause fire.

⚠ CAUTION: When using cleaning solvents work in a well-ventilated area. Many cleaning solvents are toxic if inhaled.

Your machine may be shipped with a rustproof waxy coating and/or grease on the exposed unpainted metal surfaces. Fully and completely remove this protective coating using a degreaser or solvent cleaner. Moving items will need to be moved along their travel path to allow for cleaning the entire surface. For a more thorough cleaning, some parts will occasionally have to be removed. **DO NOT USE** acetone or brake cleaner as they may damage painted surfaces.



Follow manufacturer's label instructions when using any type of cleaning product. After cleaning, wipe unpainted metal surfaces with a light coating of quality oil or grease for protection.



Important: This waxy coating is **NOT** a lubricant and will cause the machine to stick and lose performance as the coating continues to dry.



TRANSPORTING AND LIFTING



IMPORTANT: Lifting and carrying operations should be carried out by skilled workers, such as a truck operator, crane operator, etc. If a crane is used to lift the machine, attach the lifting chain carefully, making sure the machine is well balanced.

Follow these guidelines when lifting with truck or trolley:

- The lift truck must be able to lift at least 1.5 – 2 times the machines gross weight.
- Make sure the machine is balanced. While transporting, avoid rough or jerky motion, and maintain a safe clearance zone around the transport area.
- Use a fork lift with sufficient lifting capacity and forks that are long enough to reach the complete width of the machine.
- Remove the securing bolts that attach the machine to the pallet.
- Approaching the machine from the side, lift the machine on the frame taking care that there are no cables or pipes in the area of the forks.
- Move the machine to the required position and lower gently to the floor.
- Level the machine so that all the supporting feet are taking the weight of the machine and no rocking is taking place.

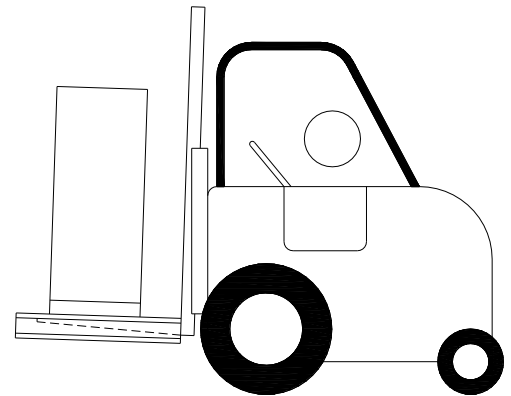



Follow these guidelines when lifting crane or hoist:

- Always lift and carry the machine with the lifting holes provided at the top of the machine.
- Use lift equipment such as straps, chains, capable of lifting 1.5 to 2 times the weight of the machine.
- Take proper precautions for handling and lifting.
- Check if the load is properly balanced by lifting it an inch or two.
- Lift the machine, avoiding sudden accelerations or quick changes of direction.
- Locate the machine where it is to be installed, and lower slowly until it touches the floor.

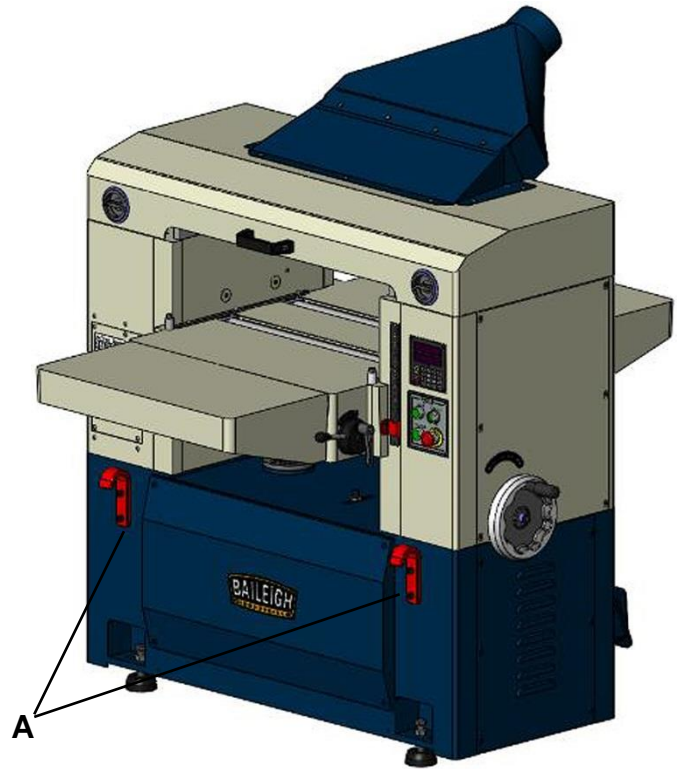

INSTALLATION

IMPORTANT:

Consider the following when looking for a suitable location to place the machine:

- Overall weight of the machine.
- Weight of material being processed.
- Sizes of material to be processed through the machine.
- Space needed for auxiliary stands, work tables, or other machinery.
- Clearance from walls and other obstacles.
- Maintain an adequate working area around the machine for safety.
- Have the work area well illuminated with proper lighting.
- Keep the floor free of oil and make sure it is not slippery.
- Remove scrap and waste materials regularly, and make sure the work area is free from obstructing objects.
- It is important to maintain free area around the machine, which is required for the working place. If any long material is machined, it is necessary to have a sufficient room in front of the machine as well behind it in the places of material input and output.



- **LEVELING:** The machine should be sited on a level, concrete floor. Provisions for securing it should be in position prior to placing the machine. The accuracy of any machine depends on the precise placement of it to the mounting surface.
- **FLOOR:** This tool distributes a large amount of weight over a small area. Make certain that the floor is capable of supporting the weight of the machine, work stock, and the operator. The floor should also be a level surface. If the unit wobbles or rocks once in place, be sure to eliminate by using shims.
- **WORKING CLEARANCES:** Take into consideration the size of the material to be processed. Make sure that you allow enough space for you to operate the machine freely.
- **POWER SUPPLY PLACEMENT:** The power supply should be located close enough to the machine so that the power cord is not in an area where it would cause a tripping hazard. Be sure to observe all electrical codes if installing new circuits and/or outlets.

Base Levelling

⚠ WARNING: Before operating; make sure it is positioned firmly on a solid level floor. If it tips over on you, it could cause severe injury or death.

The machine should be sited on a level, concrete floor. The accuracy of any machine depends on the precise placement of it to the mounting surface. Locate the planer in an area that is level and provides a solid foundation. Make sure that any potential kickback is not in line with aisles, doorways, wash stations or other work areas.

- Place shims under the four feet (B) mounted in the base as required for leveling.
- Place a level on the table of the planer and adjust leveling bolts (C) until the machine is resting level. Tighten the hex nuts (D) against the base of the planer to keep the leveling bolts from turning.





ASSEMBLY

⚠ WARNING: For your own safety, **DO NOT** connect the machine to the power source until the machine is completely assembled and you read and understand the entire instruction manual.

1. Use an assistant and the exploded parts diagrams; assemble the loose parts to the planer.
2. Verify that items such as dust collection, power supply, extension tables ect. Do not interfere with the main table infeed and outfeed or access to the controls.

Extension Table

1. Use an assistant to help lift and align the holes on the extension table to the main table.
2. Insert the bolts and loosely secure with washers and nuts.
3. With the fasteners in position and snug, place straight edge through machine so that it lies across the main table and extension table.
4. Align the extension table to the main table. When the tables are aligned, hold in position and securely tighten the fasteners.

Dust Chute Assembly

- Mount the dust chute to the planer hood with eight M6 x 10 hex head screws.
- Make sure the dust collection system has sufficient capacity and suction for your planer.
- Always turn on the dust collection system before starting the planer.



ELECTRICAL

⚠ WARNING: Baileigh Industrial is not responsible for any damage caused by wiring up to an alternative 3-phase power source other than direct 3-phase. If you are using an alternate power source, consult a certified electrician or contact Baileigh Industrial prior to energizing the machine.

⚠ CAUTION: HAVE ELECTRICAL UTILITIES CONNECTED TO MACHINE BY A CERTIFIED ELECTRICIAN!
Check if the available power supply is the same as listed on the machine nameplate.

⚠ WARNING: Make sure the grounding wire (green) is properly connected to avoid electric shock. DO NOT switch the position of the green grounding wire if any electrical plug wires are switched during hookup.

Motor Specifications

Your tool is wired for 220 volt, 60Hz alternating current. Before connecting the tool to the power source, make sure the machine is cut off from power source.

Considerations

- Observe local electrical codes when connecting the machine.
- The circuit should be protected with a time delay fuse or circuit breaker with a amperage rating slightly higher than the full load current of machine.
- A separate electrical circuit should be used for your tools. Before connecting the motor to the power line, make sure the switch is in the "OFF" position and be sure that the electric current is of the same characteristics as indicated on the tool.
- All line connections should make good contact. Running on low voltage will damage the motor.
- In the event of a malfunction or breakdown, grounding provides a path of least resistance for electric current to reduce the risk of electric shock. This tool is equipped with an electric cord having an equipment-grounding conductor and a grounding plug. The plug must be plugged into a matching outlet that is properly installed and grounded in accordance with all local codes and ordinances.



⚠ WARNING: In all cases, make certain the receptacle in question is properly grounded. If you are not sure, have a qualified electrician check the receptacle.

- Improper connection of the equipment-grounding conductor can result in risk of electric shock. The conductor with insulation having an outer surface that is green with or without yellow stripes is the equipment-grounding conductor. If repair or replacement of the electric cord or plug is necessary, do not connect the equipment-grounding conductor to a live terminal.
- Check with a qualified electrician or service personnel if the grounding instructions are not completely understood, or if in doubt as to whether the tool is properly grounded.
- Repair or replace damaged or worn cord immediately.

Connecting Power Supply

You may either install a plug or “hard-wire” the Planer directly to a control panel.

- If you are connecting a plug, use a proper UL/CSA listed 3-pole, 3-wire grounding plug suitable for 230 volt operation.
- If the Planer is to be hard-wired to a panel, make sure a disconnect switch is readily available for the operator.
- During hard-wiring of the Planer, make sure the fuses have been removed or the breakers have been tripped in the circuit to which the Planer will be connected. Place a warning placard on the fuse holder or circuit breaker to prevent it being turned on while the machine is being wired. **Always** follow proper lockout /tagout procedures.

1. Lock power out to the circuit that will provide power to the machine.
2. Remove the electrical box cover.
3. Route the electrical cable into the electrical box.
 - a. Route the power cord so that it will NOT become entangled in the machine in any way.
 - b. Route the cord to the power supply in a way that does NOT create a trip hazard.
4. Connect the three power wires terminals **L1, L2, & L3**. Connect the ground wire (typically green) to the **E** terminal.





5. Check that the power cord has not been damaged during installation.
6. Connect the ground wire (typically green) to the “E” (Safety Ground) terminal (not visible in this view).
7. Install the electrical box cover.
8. With power connected and the main disconnect turned ON, the control panel will be lit.
9. Push the table up button to raise the table and the table down button to lower the table.
10. If not, disconnect power to the machine, and switch the L1 and L3 wires. DO NOT move the ground wire.



CONTROLS IDENTIFICATION

A. Emergency Stop Button: Stops all functions of machine, but the planer still has power. To reset, rotate switch clockwise until the button pops out.

B. Main Motor: Starts rotation of Cutterhead. Will not work if the “Emergency Stop” switch is engaged, or hood is open.

C. Digital Thickness Controls: Displays and controls table position, units, etc..

D. Table Up: Raises the table.



Note: Table will contact the upper limit switch at about 5/8". You can continue to raise the table manually by using the handwheel.

E. Table Down: Lowers the table.



Note: Table will contact the lower limit switch at about 8-5/8". You can continue to lower the table manually by using the handwheel.

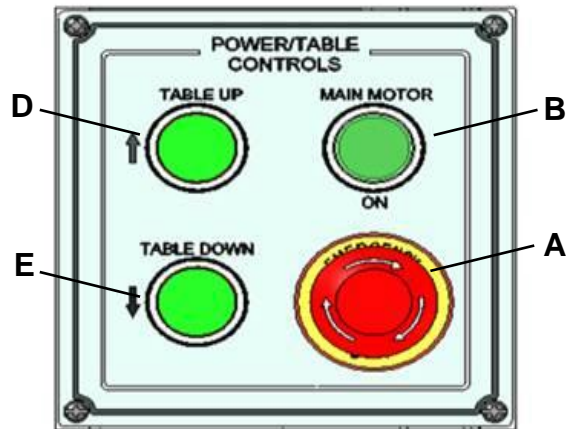
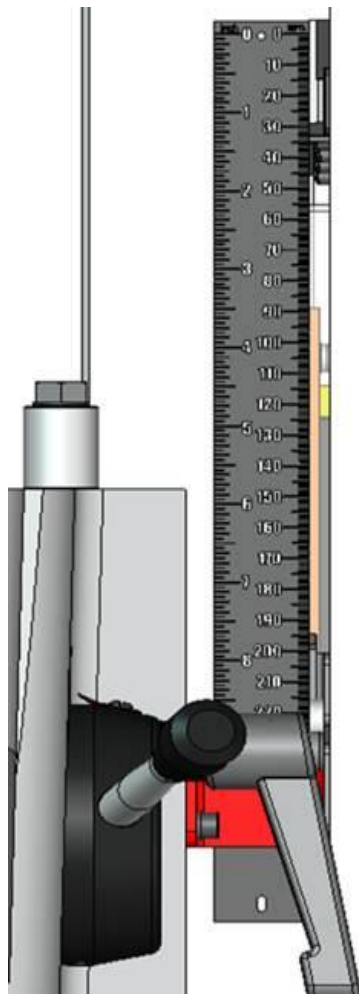



INTERNAL COMPONENT IDENTIFICATION

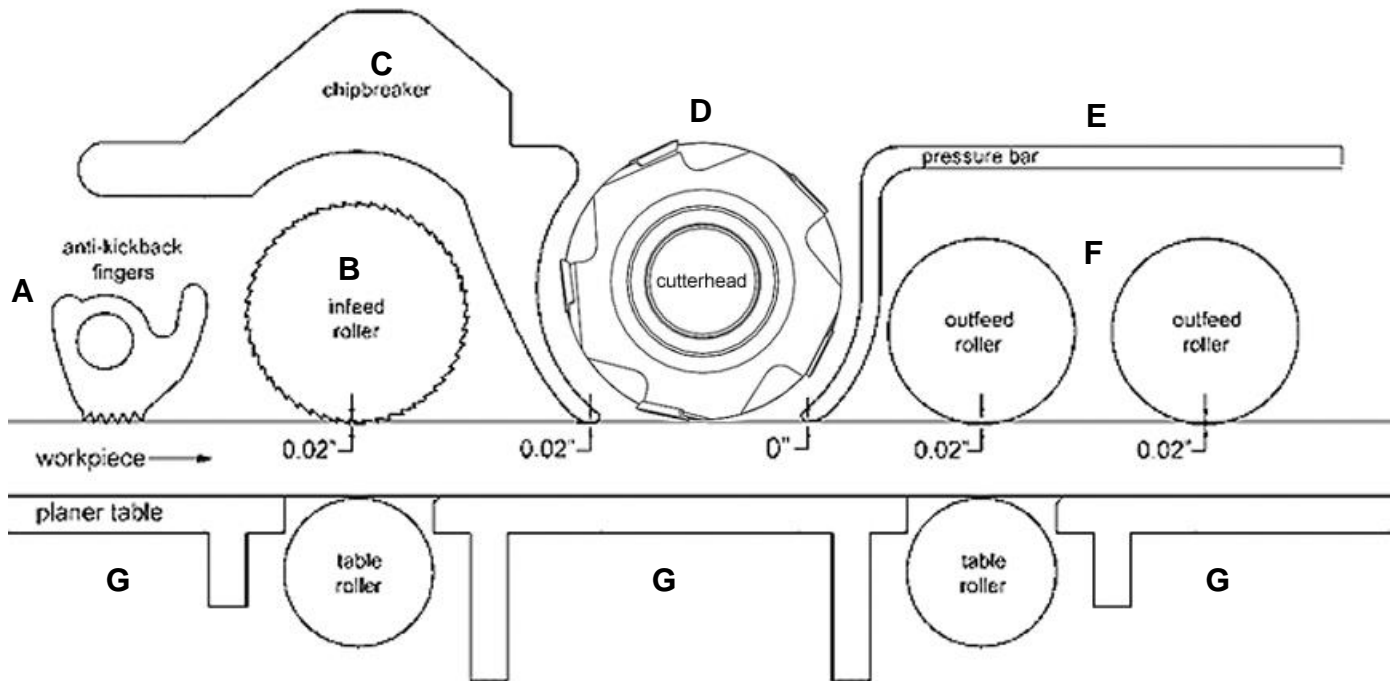

- A. **Anti-Kickback Fingers:** Provide additional safety for the operator.
- B. **Serrated Infeed Roller:** Pushes workpiece toward the cutterhead.
- C. **Chipbreaker:** Breaks off chips created by the cutterhead to prevent tear out and diverts the chips to the dust port.
- D. **Cutterhead:** Holds the carbide inserts in a longitudinal pattern that plane the workpiece.
- E. **Pressure Bar:** Stabilizes the workpiece as it leaves the cutterhead and assists in deflecting wood particles toward the dust hood.
- F. **Outfeed Rollers:** Pulls the workpiece toward the outfeed table.
- G. **Working Table:** Provides a smooth and level path for the workpiece as it moves through the planer.



OPERATING CONTROLLER

The operating controller is used to control the table height. The height may be controlled directly from the key pad, or a setting may be entered and then controlled by pressing the table up or table down button on the control panel.

The top LED display shows the Target value. This is the value that has been programmed into the controller.

The lower LED display shows the Real value. This is the position the table is currently at. The key pad is used to enter, store, change etc. the values needed by the operator.



LED / KEY	Description	KEY	Description	KEY	Description
Upper Window	Target value		Manual / Single mode		Parameter
Upper LED	Target value LED		Program		mm / inch
Lower Window	Current value		Active		Clear / Return
Lower LED	Current value LED		Stop / Cancel		Confirm / Enter
0 ~ 9	Number keys		+ / -		Decimal

Note: Display : LED on / blinks



Function:

- | | | | |
|---|---------------------------------|----|-----------------------------------|
| 1 | One or two speed positioning | 7 | Resolution: 0.1mm/ 0.05mm/ 0.01mm |
| 2 | Manual / Single mode | 8 | Correct zero point |
| 3 | 10 sets single program | 9 | Display: RPM speed |
| 4 | 10 sets tool offsets | 10 | Protection for tool / motor fault |
| 5 | Quick program / Fine Adjustment | 11 | Battery life 2.5 year |
| 6 | Inch / mm conversion | 12 | Self-diagnose |

Operation Modes

There are two base operating modes – MANUAL and SINGLE.

In MANUAL mode, the operator can raise or lower the table using the Controller keypad. In SINGLE mode, the table will move to the pre-set value when you push the “Table Up” or “Table Down” buttons on the planer’s control panel.

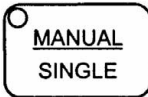
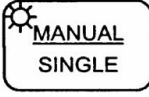
1. Press the  button to switch between Manual mode or Single mode.
2. The LED lamp  in the upper left corner of the key indicates which mode is currently selected.

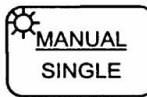
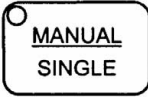
ON  = Manual mode, OFF  = Single mode.

MANUAL MODE

Keyboard Function:

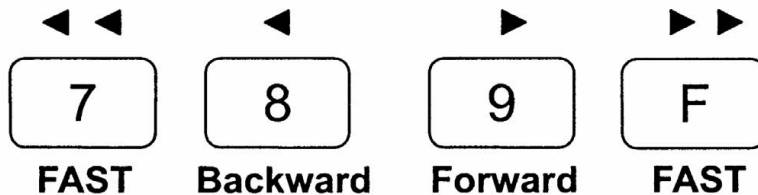

For planer table operations, the fast forward and fast backward keys have the same function as the forward and backward keys.



When the forward key is pressed, the planer table moves down. This is also achieved using the “Table Down” push button on the planer. When the keypad is used, the upper display will show

= HAnd

while the 7 or 8 key is held.

When the backward key is pressed, the planer table moves up. This is also achieved using the “Table Up” push button on the planer. When the keypad is used, the upper display will show

HAnd =

while the 9 or F key is held.



In Manual Mode, the planer table moves as long as a key is pressed and held. When the key is released, the table stops.

This mode can be used for manual positioning, or adjusting procedures.

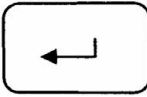

SINGLE MODE

In single mode, the device performs automatic positioning of the table to the programmed target position. The “Table Up” or “Table Down” button on the planer should be pushed and held; when the table has fully adjusted to the target position, the table will automatically stop in position. Release the push button.





Setting Target Value

1. Press  (Target window [upper] LED starts blinking)
2. Enter the target value using numerical keypad.
3. Press  to complete.
4. The  LED lamp starts blinking. The controller is ready to start the positioning.

Start/Stop/Cancel

1. Press the  key to start the positioning. The LED lamp now stops blinking and remains on during the procedure.
2. Press the  key to cancel the positioning. The LED lamp is turned off.

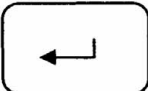

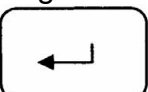
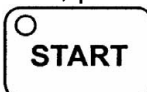
3. If the  key is pressed while the positioning is running, the procedure is interrupted, the machine is stopped, and the  LED is turned off.
4. To repeat the positioning of the same target, press , , .
5. To program another target value, press the  key, enter the NEW value and press the , and then the  keys.

Example:

Assume:



target value on display = 100.00mm
real value on display = 100.00mm

To change the target value to 20.25mm,

1. Press the  key, the LED lamp on Target window will be blinking.

Display	1 0 0 . 0 0 	Target value
	1 0 0 . 0 0	Current value

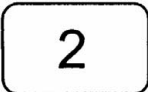
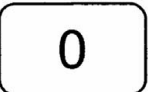
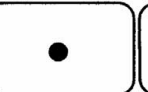
2. To enter the new target value (example: 20.25mm),



Press the      keys in the order shown.

Display	2 0 . 2 5 	Target value
	1 0 0 . 0 0	Current value

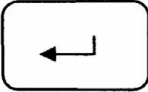

3. Press the  key to complete.

The  LED lamp will be blinking indicating the controller is ready for positioning.

4. Press the  key to start the positioning or press the  key to cancel.

FAST PROGRAM (10 SETS)

To facilitate frequently used positions, such as matching dimensional lumber thicknesses, the keys 0 to 9 have associated preset target values. By pressing one of these keys, its target value is loaded automatically, and the positioning can be started immediately.

Entering Preset Target Values:

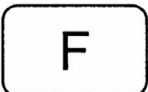
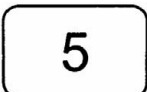
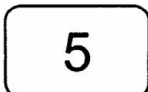
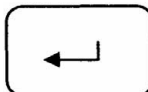
1. Press    .

2. Select a key 0 to 9 (total of 10 values).

3. Enter the target value.

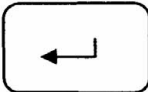
4. Press  to confirm.

5. Follow the same procedure for entering the other preset target values.

6. Press  to exit.

Example:

To Enter Value in Program 0 = 10.00mm; and the Program 1 = 20.00mm

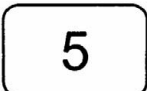
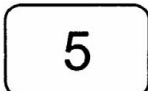
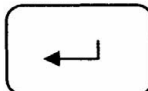
1. Press    .

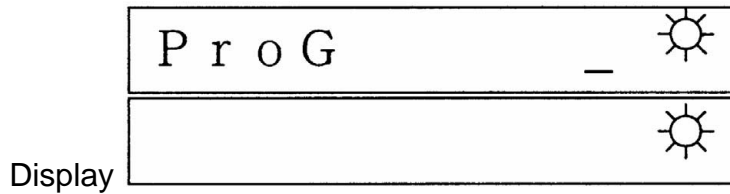

2. Press - [to select program key 0]
3. Press - [to enter desired value]. For this example this is 10mm. In imperial measurements this would be 0.393" (Entered as .393)
4. Press - [to complete this entry]
5. Press - [to select program key 1]
6. Press - [to enter desired value]. For this example this is 20mm. In imperial measurements this would be 0.787" (Entered as .787)
7. Press - [to complete this entry]
8. Press to exit.

Execute:

1. Enter single mode, LED lamp is off.
2. Press a key 0 to 9.

LED lamp is blinking, ready for start.



Example:

To Select and Run Program 0 = 10.00mm; or Program 1 = 20.00mm.

1. In Single Mode,  LED lamp is off.

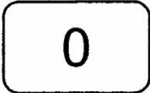
2. Press  - [to program 0]



Now you will see the preset value: 10.00mm (Program 0)

 LED lamp is blinking, complete.

3. Press  to begin positioning.

SELECT COUNTING DIRECTION

You can select the counting direction according to the table movement.

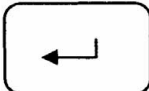

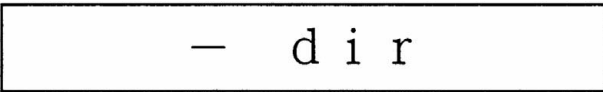
1. Press   [default]

Display 

2. Press  to change the direction.



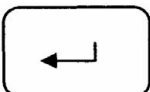



“-dir” numbers decrease as table rises (accords with scale on planer).

“dir-“ numbers increase as table rises.

3. Press  to confirm or press  to clear.

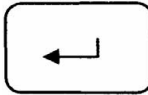

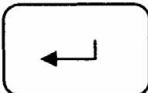
SELECT POSITIONING MODE

1. Press   .
2. Press  to select.
 - a. ---| |--- both directions
 - b. ---| left
 - c. |--- right
3. Press  to confirm or press  to clear.

SET SOFTWARE LIMIT (HI/LO END)

There are High and Low software limits. If these are exceeded, the display will give an error message.

To set the Lo_End press    .

To set the Hi_End press    .

SET TOLERANCES

The tolerance defines the accuracy of the positioning.

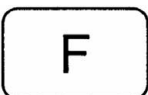
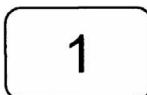
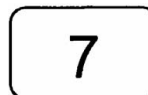
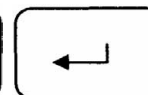
1. Press    .

Display



t o l l

0.30

[default]

2. Enter the value for tolerance.

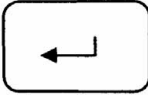

3. Press  to confirm or press  to clear.

SET LOW SPEED LIMIT

This function defines the speed level which is considered abnormal for the machine. When the Controller starts the table movement up or down, and the table does not move, or moves with a speed lower than defined, it stops the machine and displays:

Display

E n G i n E
F A u l t

1. Press  to clear.

To set low speed limit:

2. Press

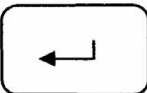
F	1	9	
---	---	---	---

.



Display

F A u l t
5 5

[default]

3. Enter the low speed level 0 to 99

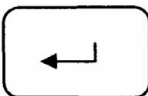
- 0 = Machine test is disabled
- 1 = very low
- :
- :
- 99 = high

4. Press  to confirm or press  to clear.



SET LINEAR CORRECTION



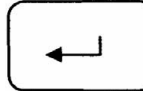

Note: Setting Linear Correction should be done in MM (metric) mode, not inches. This will ensure accurate readings for table movement.

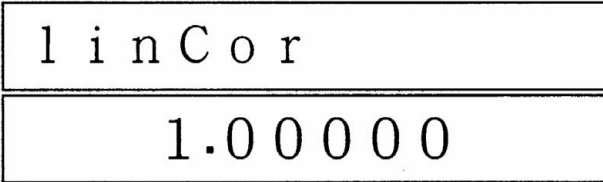
1. Press    .

Display 

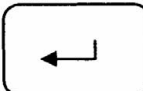
2. Enter the value between 0.0001 and 9.9999

3. Press  to confirm or press  to clear.



CHECK SOFTWARE VERSION

To check the released version of the Controller program:

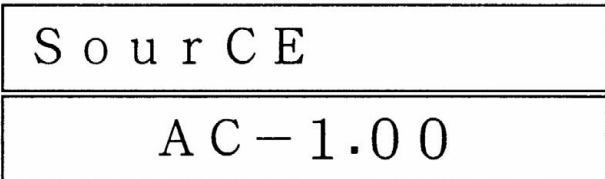
1. Press    .

Display 

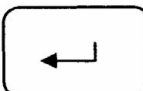
In the real value window, you will see the released version.

2. Press  to confirm or press  to clear.





LOAD DATUM VALUES

The real value refers to the distance between the machine table and the cutterhead. Thus, the cutterhead defines the zero point of the machine. It is, however, difficult or impossible to move the planer table to this point. Therefore, the zero point should be identified by either placing a gauge between table and cutterhead knife insert, or by planing a test board then measuring the board thickness with calipers.

Program this real value into the Controller as follows.

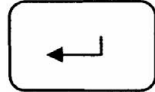
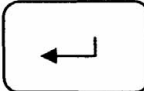

Preset the Real Value:

1. Press   .
2. Enter the value.
3. Press .

Load the Real Value:

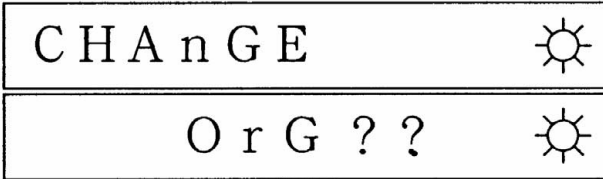
1. Press   .

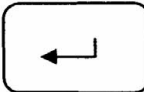
Display 

2. Press  to confirm or press  to cancel.



Example:

The current value is 10.00mm but the actual thickness is 10.50mm.

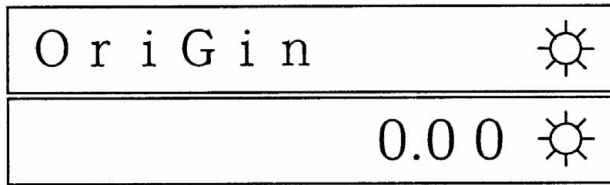
1. Press   .

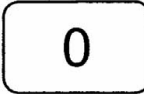

Display

2. Press    

3. Press 

4. Press   



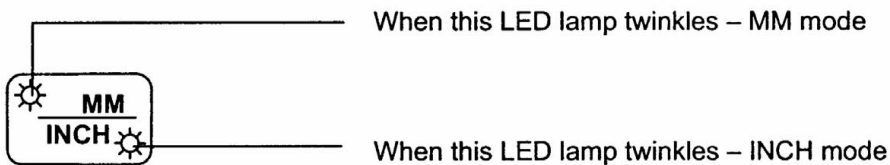

CONVERSION - IN/MM

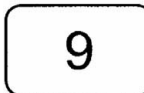
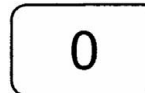
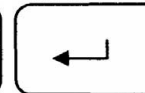

The dedicated mm/inch key allows for immediate switch of the units between millimeters and inches. The LEDs on the key indicate the selected unit. Switching between MM and INCHES has no effect on the control functions.

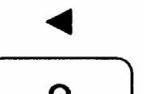

SET DEVICE RESOLUTION

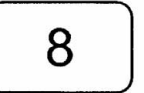
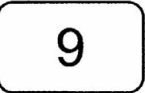
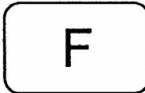
1. Press    

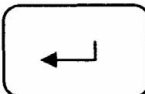
2. Use          to select resolution.







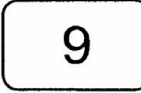
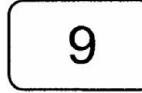
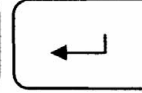

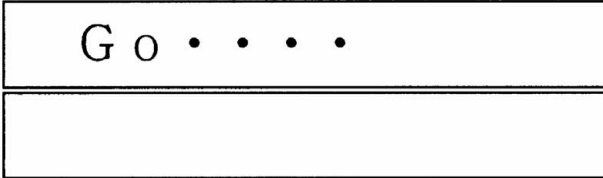
3. Press  to confirm or press  to clear.



CALIBRATION

1. Press    .

Display 

2. Use          to move the planer table until the controller terminates the calibration and restarts.

CONTROLLER SPECIFICATIONS

Feature	Technical Data	Additional Information
Supply Voltage	24 VDC 50ma	C Type Battery x 1
Battery Voltage Control	Yes	Low Power Alarm Via Display
Display	15mm LED x 6 Digits x 2 Line	
Output	4 Digital Output	AC250V / 7A AC110V / 7A DC24V / 10A
Input	4 Digital Input	24VDC
Operating Elements	20 Button Keyboard	
Travel Speed	1.5m/S	
System Accuracy	± (0.025+0.02L)mm L: Meter	
Repeatability	0.01mm	
Temperature Range	Working Temperature 0+ 50°C	Storage Temperature -20+70°C
Humidity	Max. 95% Rf	Condensation Not Permitted



PARAMETER

Parameter	Display	Description	Default	Remarks
0	CHAnGE	Load datum value	0	
1	dir	Select counting direction (+ / -)	-dir	
2	OriGin	Load origin	0.00mm	
3	OffS-	Set tool diameter	0.00mm	
4	POSdir	Positioning mode	-- --	
5	SPEEd	One or two speed positioning	1sp	
9	LoAd 0	Load tool diameter	0.00	
10	Lo-End	- Software limit	-50.00mm	
11	Hi-End	+ Software limit	1000.00m m	
15	InPOS	Positioning output time	0.15ms	
17	toLL	Tolerance	0.30mm	
19	FAuLt	Low speed limit	55	
20	LinCOr	Linear correction	1.00000	
30	PASS	Parameter lock	----	
33	SOurCE	Software version		
55	PrOG-	Fast program		
90	rES	Resolution	0.01mm	
99	GO....	Sensor calibration		

ENTER PARAMETER SETTINGS MODE

With this function, you can select each parameter to be locked or unlocked. When a parameter is locked, the user can see the value, but cannot change it.

1. Select single mode  LED lamp off

2. Press    

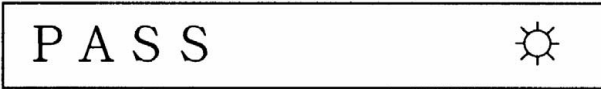
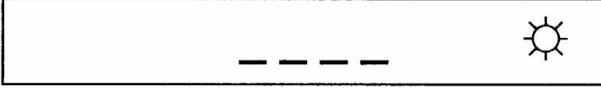
Display  



3. Enter the password. (2201)

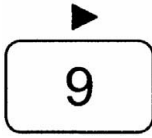

4. Use  to scroll through the parameters.



5. Press  to lock or unlock.

On = unlock

Off = lock

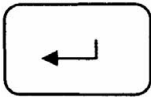

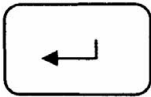
6. Press  to confirm or press  to clear.

CONTROLLER TROUBLESHOOTING

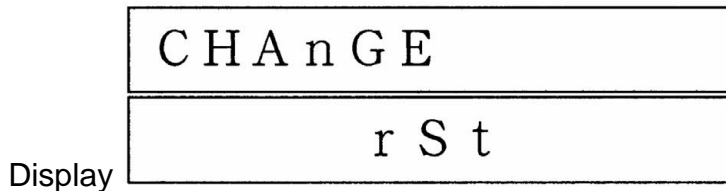

“Change RST” message appears when the Controller detects a motion in the wrong direction. For example, the Controller switches the outputs to move upward but the table starts moving in the reverse direction. Usually this is caused by the wrong wiring of the three phase motor.



1. Press  to clear.
2. Check the wiring and change if necessary.

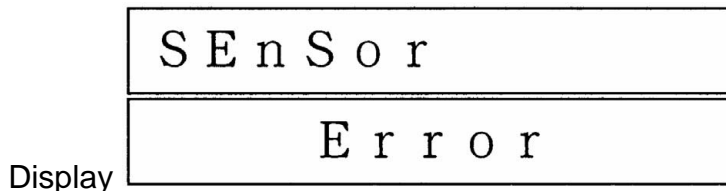

Possible cause:

- a. no sensor
- b. 9-pin connector is loose
- c. wire broken
- d. the gap between sensor and tape is too large



Excluding: Check the sensor, sensor cable, and sensor connector.

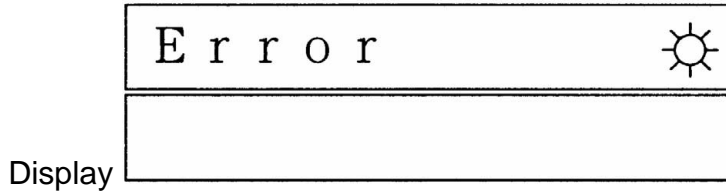

Possible cause: Incorrect operation.

Excluding: Press  to clear.

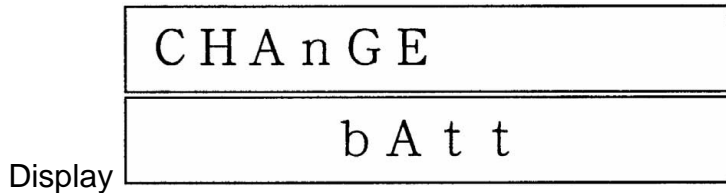

This message appears after power-on and indicates battery discharged. The C-type battery **MUST** be replaced to resume the operation of the device.

Change as follows:

1. Open the planer's top right side panel to access the rear of the Controller.
2. Turn the power off. Be careful not to move the table during power off.
3. Replace the battery and turn the power on. The device will resume normal operation.



RAISING AND LOWERING TABLE

Turn the handwheel (A) clockwise to raise the table. One revolution equals 1/32" or 0.03".



Note: The handwheel is spring loaded. Push in on the handwheel and rotate until the pins engage the detents.

ADJUSTING THICKNESS SCALE

1. Run a board through the planer and measure the thickness of the planed board with a pair of calipers.
2. Adjust the pointer (B) by loosening the screw that holds it in place.



Note: This measurement should be the same as digital readout.

TABLE ROLLER ADJUSTMENT

1. Loosen the handle (C) and move the table rollers up, or down by raising, or lowering the handle (D).
2. When you reach the desired position tighten the handle.

The rollers are usually set higher when planing rough stock. When planing smooth stock the table rollers should be set slightly above, or flush with the table.





CHANGING FEED RATE

The planer has nine selectable feed speeds that feed stock from 10 to 30 feet per minute. To adjust speed, turn knob (E) until it clicks into place.



Important: Change feed speed only while the feed system is RUNNING!

TABLE STOP

The socket head cap screws (F) act as a stop and prevent you from running the table into the cutting and feeding assembly.

OPENING HOOD

Turn the locks (G) to open the hood. The hood will open automatically. Use the handle (H) to shut the hood.

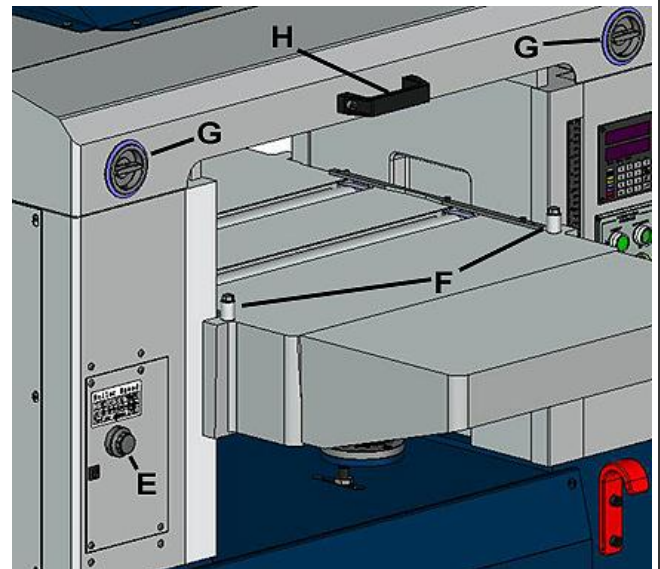
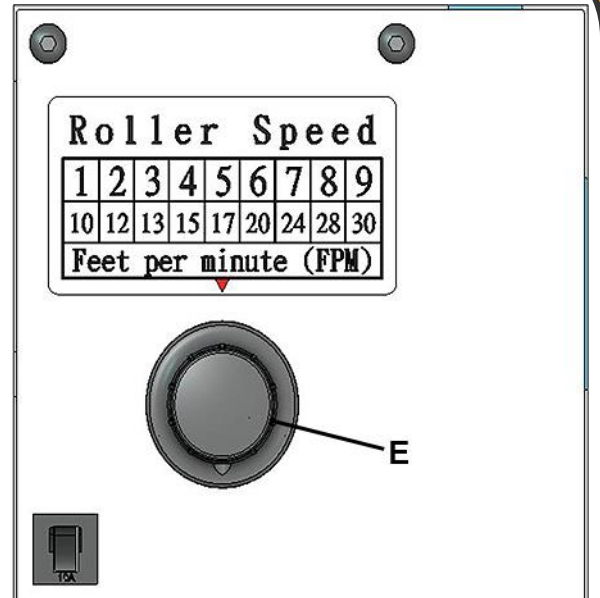



SETUP OF FEED ROLLERS, CHIP BREAKER AND PRESSURE BAR

⚠ WARNING: Always disconnect and lockout power before performing any adjustments or service work.
Blades and Anti-kickback fingers are sharp. Wear gloves to prevent injury.

Although your planer was carefully adjusted at the factory, it should be checked before being put into operation. Any inaccuracies due to rough handling while in transit can easily be corrected by completing the adjustment procedures.

To check the adjustments you will need a straight edge, feeler gage and a homemade gauge block made of hardwood.

Use the diagram and dimensions to fabricate the hardwood gauge block.

The wood gauge along with a feeler gauge will be used to set the planer to the proper dimensions.

Depending on the stock and cutterhead you may find that a different setup may work better for your particular planing operation.

Hardwood Gauge Block

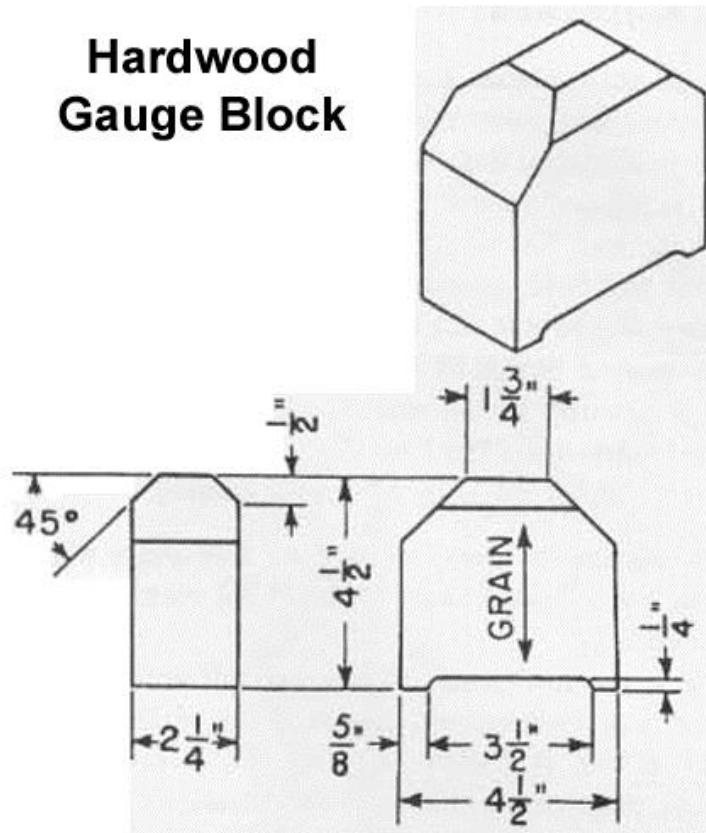



Adjustment Dimensions

All measurements are shown below knife.

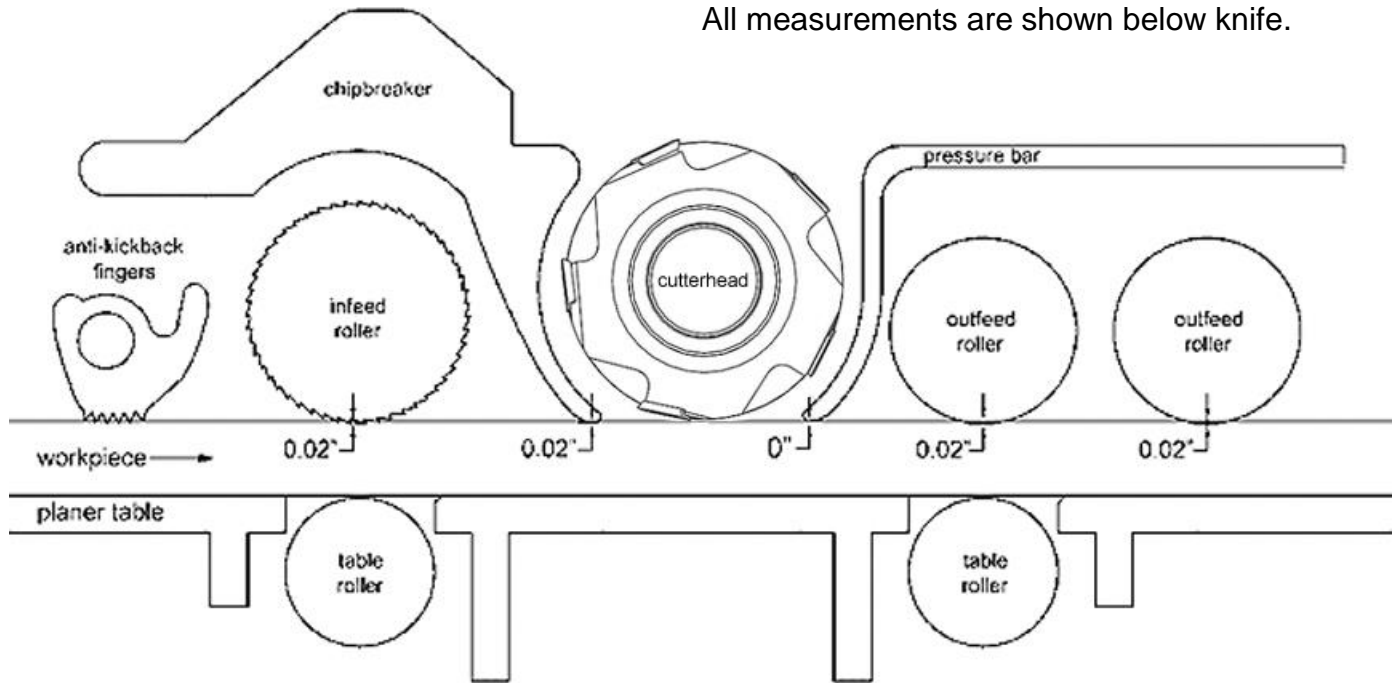



ANTI-KICKBACK FINGERS

Anti-kickback fingers are provided to prevent kickback. These fingers operate by gravity and it is necessary to inspect them occasionally to make sure they are free of gum and pitch so that they move independently and operate correctly.

⚠ WARNING: Always disconnect and lockout power before performing any service work. Anti-kickback fingers are sharp. Wear gloves to prevent injury.

1. Disconnect and lockout power to the machine.
2. Raise the cutterhead height enough to allow for both physical and visual inspection of the anti-kickback fingers.
3. Visually inspect the fingers for any damaged, broken, or bent fingers. Also check for any accumulation of dirt, gum, or pitch and clean as needed.
4. Move the finger up and down. The fingers should raise and lower freely. They should drop to the down position with their own weight.

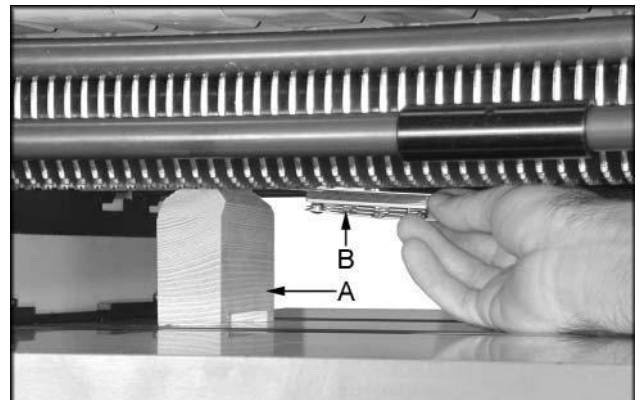

Fig. 14

IN-FEED ROLLER ADJUSTMENT

The in-feed roller should be set 0.02" below the lowest point of knife. Make sure the knives are set properly. See the "Setting / Changing Knives" section prior to making any adjustments.

1. Disconnect and lockout power to the machine.
2. Place a hard wood gauge (A, Fig 14) under a knife in cutterhead.
3. Place a 0.02" feeler gauge (B, Fig 14) on top of wood block and raise table until feeler gauge contacts the knife in its lowest position.
4. Remove feeler gauge and place wood block under the left side of in-feed roller. The top of wood gauge should just contact the in-feed roller.

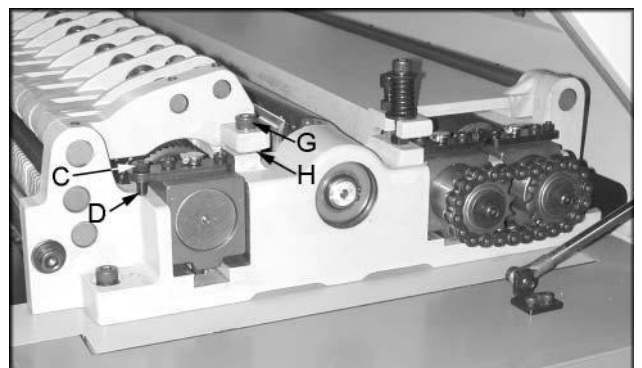

Fig. 15



5. If it doesn't, loosen jam nut (C, Fig 15) and turn the adjusting screw (D, Fig 15) to raise, or lower the in-feed roller until it contact the wood gauge.
6. Repeat for opposite side of the in-feed roller.

CHIPBREAKER ADJUSTMENT

Chipbreaker should be set 0.02" below the lowest point of knife. Make sure the knives are set properly. See the "Setting / Changing Knives" section prior to making any adjustments.

1. Disconnect machine from power source.
2. Place a hard wood gauge (A, Fig 14) under a knife in the cutterhead.
3. Place a 0.02" feeler gauge (B, Fig 14) on top of wood block and raise table until the gauge contacts the knife in its lowest position.
4. Remove feeler gauge and place wood gauge (E, Fig 16) under the left side of chipbreaker (F, Fig 16).
5. The top of the wood gauge should just contact the chipbreaker.
6. If it doesn't, remove the socket head cap screw (G, Fig 15) and remove washer (H, Fig 15), or replace with shim of proper thickness to raise, or lower the chipbreaker until it contacts the wood gauge.
7. Repeat for opposite side of the chipbreaker.

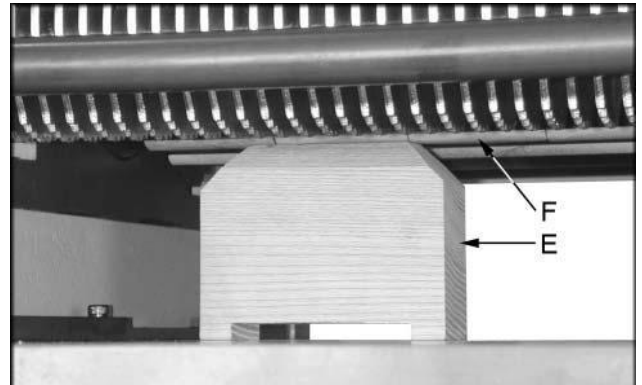

Fig. 16



PRESSURE BAR ADJUSTMENT

The pressure bar should be set even with the lowest point of knife.

1. Disconnect machine from power source.
2. Place a hard wood gauge under a knife in cutterhead. Raise table until wood gauge contacts the knife in its lowest position.
3. Place wood block (A, Fig 17) under the left side of pressure bar (B, Fig 17). The top of wood gauge should just contact the pressure bar. If it doesn't, loosen jam nut (C, Fig 18) and turn the adjusting screw (D, Fig 18) to raise, or lower the pressure bar until it contacts wood gauge.
4. Repeat for opposite side of the pressure bar.

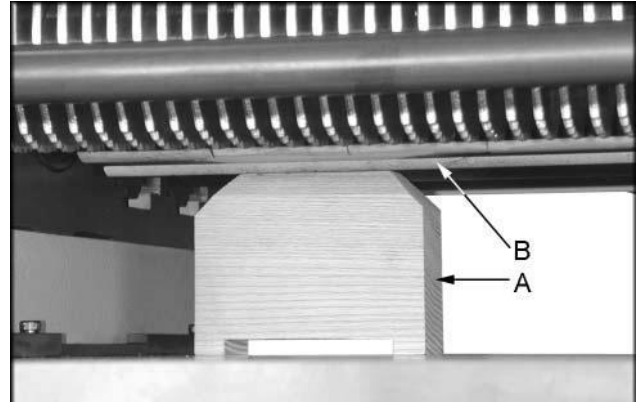

Fig. 17

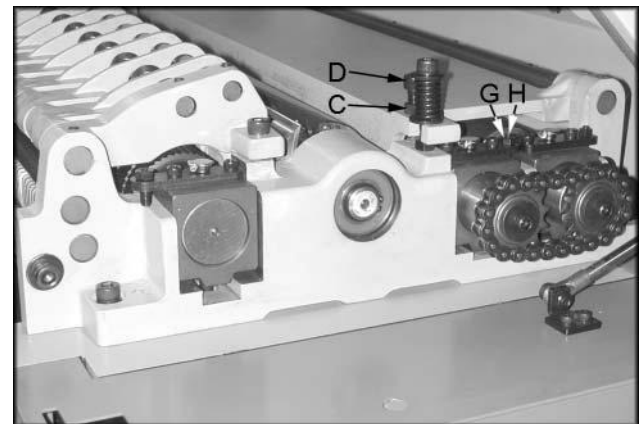

Figure 18



OUT-FEED ROLLERS ADJUSTMENT

The out-feed rollers should be set 0.02" below the lowest point of knife. Make sure the knives are set properly. See the "Setting / Changing Knives" section prior to making any adjustments.

1. Disconnect machine from power source.
2. Place a hard wood gauge (A, Fig 14) under a knife in the cutterhead.
3. Place a 0.02" feeler gauge (B, Fig 14) on top of wood block and raise table until the gauge contacts the knife in its lowest position.
4. Remove feeler gauge and place wood block (E, Fig 19) under the left side of out-feed roller (F, Fig 19).
5. The top of wood gauge should just contact the out-feed roller.
6. If it doesn't, loosen jam nut (G, Fig 18) and turn the adjusting screw (H, Fig 18) to raise, or lower the out-feed roller until it contacts wood gauge.
7. Repeat for opposite side of the out-feed roller.
8. Repeat for second out-feed roller.

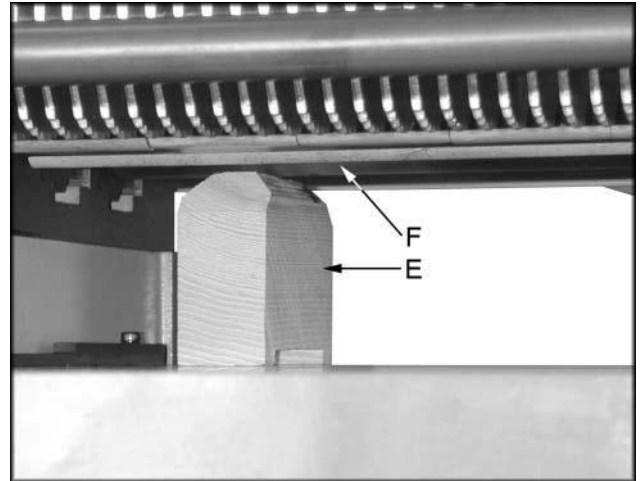

Figure 19



V-BELT ADJUSTMENT

Three V-belts (A, Fig 21) drive the cutterhead. Belt tension has been set at the factory. If the belts have stretched and need adjustment.

1. Disconnect machine from power source.
2. Open lower rear, and lower left-hand side panels.
3. Loosen and tighten four adjustment nuts (C, Fig 21) to move motor plate up, or down to increase, or decrease belt tension.
4. Tighten nuts against motor plate after adjustment is made.
5. Belts are tensioned properly when moderate finger pressure can deflect the v-belts about a 1/4"-1/2" midway between the pulleys.

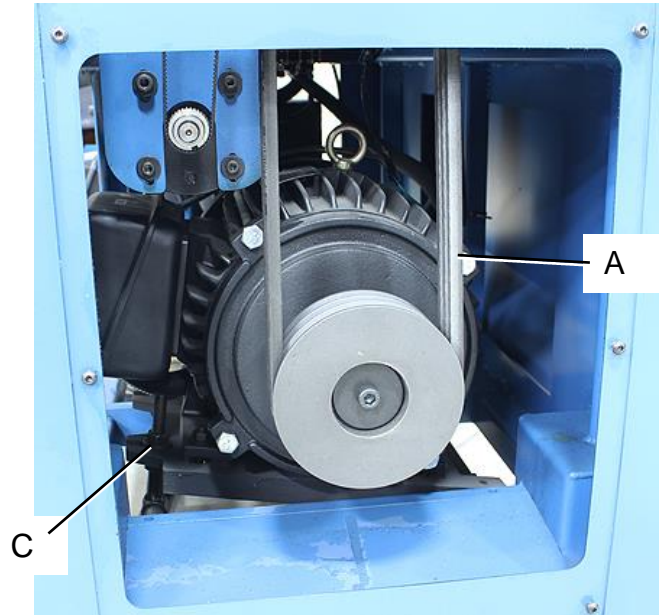

Figure 21

TABLE GIBS ADJUSTMENT

1. Adjust gibs (D, Fig 22) by loosening the hex nuts (E, Fig 22), and turning gib screws (F, Fig 22) so that the ways (G, Fig 22) are lightly contacted.
2. You should be able to get a 0.005" feeler gauge in between the gib and way.

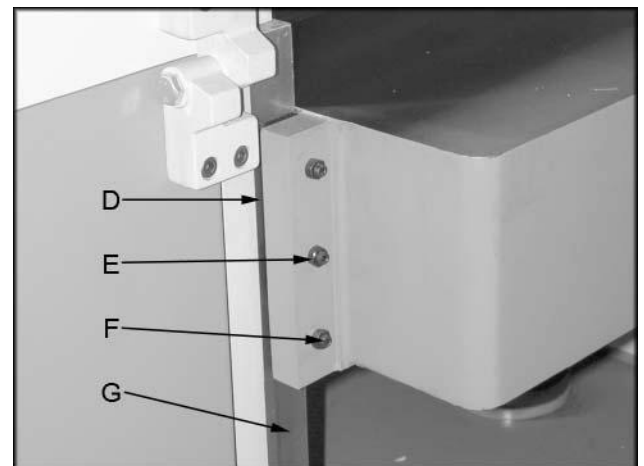

Figure 22



TABLE ADJUSTMENTS

The planer table is raised and lowered by twin screws supported on bearings, and is guided by machined surfaces on the side panels. The fit-up to prevent the table from rocking is controlled by gibs. These gibs should be adjusted individually using the three gib screws provided so that the ways are lightly contacting on all four surfaces. The gibs should be tight enough to prevent rocking or movement of the table when the planer is in operation.

To perform accurate planing the table must be parallel with the cutterhead. Lack of parallelism results in a taper over the width of the board.

To check parallelism do the following:

1. Place a gauge on the table and contacting a knife insert at the apex of its arc, Do this at each end of the cutterhead and compare the measurements.
2. If the table is not parallel to the cutterhead, place the gauge at the end that needs to be raised.
3. Loosen the three socket head cap screws (A) beneath the table.
4. Place a rod-like object (such as a hex wrench) into one of the open holes (B) and turn the shaft (C) to raise the table until the gauge reads the proper measurement. Or, the same effect can be achieved by lowering the other side of the table.
5. Re-tighten the socket head cap screws (A).

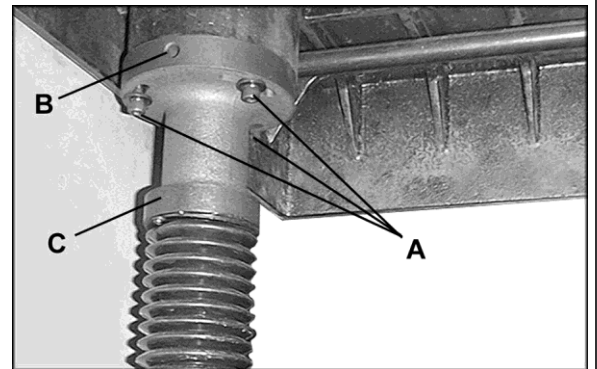
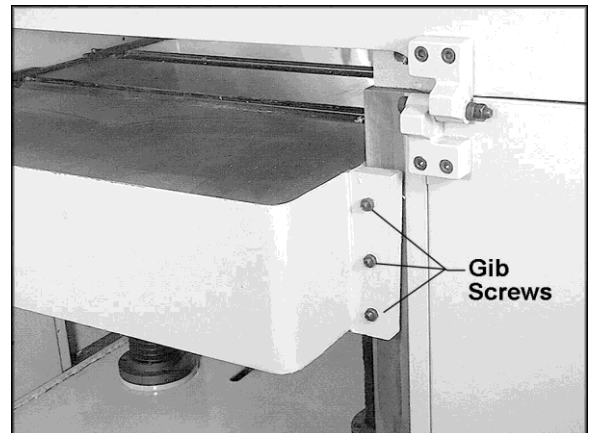



TABLE ROLLERS ADJUSTMENT

The table rollers come pre-set from the factory and shouldn't need any adjustment. If you find adjustment is necessary, follow the below listed steps.

1. Lay a straight edge (A, Fig 23) on the table across the roller (B, Fig 23).
2. Raise the rollers until it contacts the straight edge and lock the handle.
3. The pointer should be set at "0". If not adjust the pointer to read zero.



Note: Spin the roller by hand to know when roller makes contact with the straight edge.

4. Move straight edge to the opposite side of bed roller and check to see that the roller just contacts straight edge.
5. If not loosen the hex nut (C, Fig 24) and turn the hex cap bolt (D, Fig 24) to raise or lower the bed roller until it just contacts the straight edge.

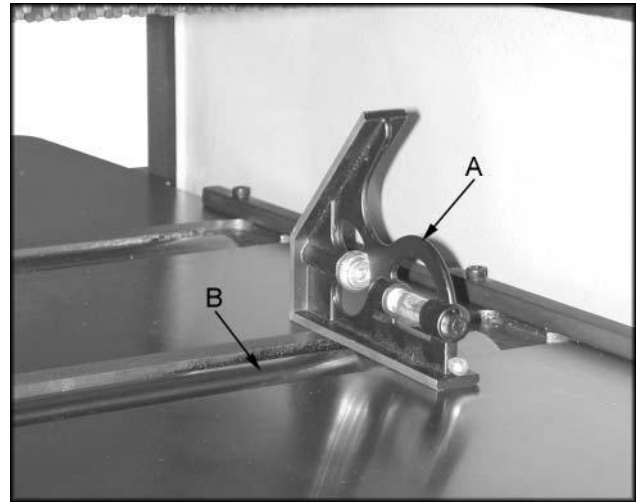

Figure 23



Figure 24



REPLACING OR ROTATING KNIFE INSERTS



WARNING: Always disconnect and lockout power before performing any adjustments or service work. Blades and Anti-kickback fingers are sharp. Wear gloves to prevent injury.

The knife inserts are four-sided. When dull, simply remove each insert, rotate it 90° for a fresh edge, and re-install.

1. Disconnect machine from power source.
2. Open the hood to access the cutterhead.
3. Use two star point screwdrivers to remove the knife insert screw. One screwdriver can be used to help hold the cutterhead in position while the other one is used to remove the screw.

It is advisable to rotate all inserts at the same time to maintain consistent cutting. However, if one or more knife inserts develops a nick, rotate only those inserts that are affected.

Each knife insert has an etched reference mark so you can keep track of the rotations.

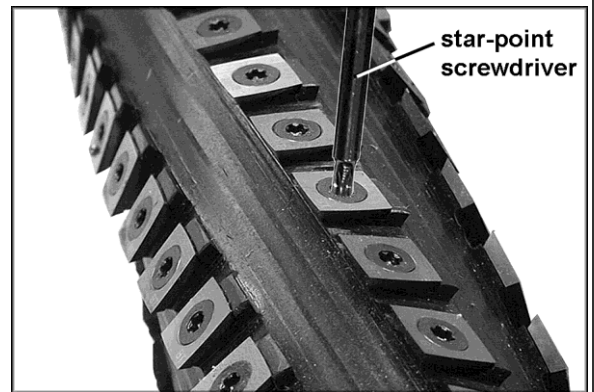

IMPORTANT: When removing or rotating inserts, clean saw dust from the screw, the insert, and the cutterhead platform. Dust accumulation between these elements can prevent the insert from seating properly, and may affect the quality of the cut.

4. Before installing each screw, lightly coat the screw threads with machine oil and wipe off any excess.
5. Securely tighten each screw which holds the knife inserts before operating the planer.



WARNING: Make sure all knife insert screws are tightened securely. Loose inserts can be propelled at high speed from a rotating cutterhead, causing injury.

6. Close and secure the hood before operating the planer.



BASIC OPERATION

⚠ CAUTION: Always wear proper eye protection with side shields, face shield, safety footwear, and leather gloves to protect from, chips, dust, burrs, and splinters.

⚠ WARNING: DO NOT stand or allow anyone else to stand directly behind infeed table while feeding material. DO NOT bend down to see how stock is feeding. Should a kickback occur, serious or fatal injury could result.

1. Put on safety glasses and a respirator, and secure loose clothing and long hair.
2. Unless your workpiece is very flat, surface plane the workpiece on a jointer until it is flat. Having the face flat will ensure that it sits flat on the planer table during operation.
3. Adjust the table elevation to slightly lower than your workpiece height (approximately 1/32" – 1/16" [0.8-1.6mm]). Cuts at this depth will usually take off the high spots.
4. Start the machine by pressing the CUTTERHEAD MOTOR switch on the power/table control.
5. Place the flat side of the workpiece down on the table, and feed the workpiece through the planer, making sure not to stand directly in front or behind the workpiece to avoid kick-back injury.

If the cut is too heavy and bogs down the planer:

- a. Turn the planer OFF immediately by pressing the red EMERGENCY STOP button on the power/table control.
 - b. Allow the planer to come to a complete stop.
 - c. Lower the table and remove the workpiece and repeat Steps 3–5.
6. Measure your workpiece thickness and adjust the table elevation as necessary to take a lighter or heavier pass, depending on your needs. For most wood types, 1/8" (3.1mm) per pass is a good cutting depth.



Operation Tips

- Inspect lumber for defects, warping, cupping, twisting, and for foreign objects (nails, staples, imbedded gravel, etc.). If you have any question about the quality of your lumber, do not use it. Remember, wood stacked on a concrete floor can have small pieces of stone or concrete pressed into the surface.
- Use the full width of the planer. When feeding lumber into the planer, alternate between the left, the right, and the middle. Your cutters will remain sharp much longer.
- Scrape all glue from workpiece before planing.
- Plane ONLY natural wood fiber. DO NOT plane MDF, plywood, laminates, or other synthetic products.
- Plane WITH the grain. Never feed end-cut or end-grained lumber into your planer.
- Do not plane boards with loose or large knots, splits, cross grain or other obvious blemishes or defects. These can damage the machine and pose a safety risk to the operator.
- Keep your work area clear.
- When planing long stock, get assistance to receive the workpiece from the outfeed table.
- Avoid planing wood with high water content. Wood with more than 20% moisture content or wood exposed to excessive moisture (such as rain or snow), will plane poorly and cause excessive wear to the cutters and motor. Excess moisture can also hasten rust and corrosion of the planer and/or individual components.

CUT TROUBLESHOOTING

Using a piece of semi-finished stock, set up for a 1/16" (1.59mm) deep cut with the quick-set table roller setting at zero. Start the machine and, standing to one side of the table, begin feeding the stock into the machine.

The infeed roller should take the material and force it under the chipbreaker and cutterhead. If the material feeds through effortlessly, examine the finished cut carefully for imperfections.

Learning to read a board for imperfections will save hours in adjusting a planer to operate properly.

Following are some problems that may arise and their probable remedies. The illustrations are exaggerated for clarity.



Feed Restriction

⚠ CAUTION: Never attempt pressure bar adjustment while the machine is connected to power.

This is caused either by the table rollers being set too low for roughing operations or from a low pressure bar. About 90 percent of the time, the pressure bar is too low. As the sharp edge of the knife inserts wear, you must compensate for this wear by slightly raising the pressure bar an equal amount on each side. Your first indication of knife wear is hesitation in feed of the material through the machine after it leaves the corrugated infeed roller on its way out of the machine. Disconnect machine from power and adjust the pressure bar accordingly. The material will free up and feed through smoothly when the planer is restarted.

Feed restriction can also occur due to pitch buildup on the table. Be sure the table surface is clean. Dusting the surface with talc occasionally will aid in smoother feeding and help prevent pitch buildup.

Clip Marks

If clip marks occur 6" (152mm) in from each end of the board, the pressure bar is too high. Turn both right and left hand adjusting screws the same amount, 1/4 turn clockwise or less, and take another 1/16" (1.59mm) deep cut. Re-examine the board.

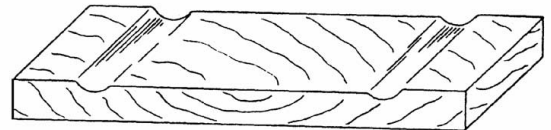

Continue the operate-adjust procedure until the clip marks disappear. Should the board fail to feed through, back off slightly on both adjusting screws until feeding is smooth and the imperfections do not re-appear. Lock the pressure bar adjusting screws with the jam nuts provided.

Chatter

Chatter marks usually appear on thin material. Even at their lowest point, the table rollers are too high to handle thin material. Solve the problem by either using a slave board or making an auxiliary table out of Formica countertop material with cleating at each end of the table to keep it stationary over the planer table.

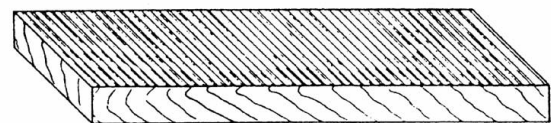



Snipe

Some amount of snipe may be inevitable with many planer operations, but proper planer adjustments can so minimize snipe as to make it negligible.

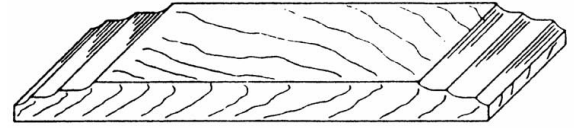

If noticeable snipes appear on each end of the material, a table roller is too high causing a slight lift of the material as it passes through the machine. Normally these snipes are more noticeable on the trailing end of the board than on the lead end, and most often occur during planing of rough lumber.

Table rollers must be elevated for running rough or resaw lumber through the machine. When material is turned over to surface the other side, and you neglect to lower the table rollers for a finish cut, then definite snipes will appear on the ends of the material.

Tapers

If the machine planes a taper across the full width of the board, the table is not parallel with the cutterhead. First check that all knife inserts are properly installed. If they are, then the table itself must be adjusted. See "SETUP OF FEED ROLLERS, CHIP BREAKER AND PRESSURE BAR".

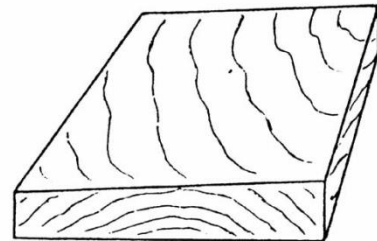

Twisting

If material twists while feeding through the planer, either the table rollers, pressure bar, or outfeed roller may be out of level. See "SETUP OF FEED ROLLERS, CHIP BREAKER AND PRESSURE BAR".

Halted Feeding

If the in-feed roll takes stock away from you while feeding, then feeding stops before contacting the knives, the chipbreaker is probably too low. Or the in-feed roller is not set low enough, or does not have enough pressure. In a similar situation, the in-feed roll takes the stock, the chipbreakers lift, and stops as you hear the knives contact the material. In this case the pressure bar is too low. See "SETUP OF FEED ROLLERS, CHIP BREAKER AND PRESSURE BAR".



MAINTENANCE



WARNING: Make sure the electrical disconnect is OFF before working on the machine.

Maintenance should be performed on a regular basis by qualified personnel.

Always follow proper safety precautions when working on or around any machinery.

Maintenance on your planer should be done at periodic intervals to ensure that the machine is in good working order. Inspection and maintenance should be performed at least twice a year but more often if the lathe receives constant use.

- Check daily for any unsafe conditions and fix immediately.
- Check that all nuts and bolts are properly tightened.
- On a weekly basis clean the machine and the area around it.
- Lubricate threaded components and sliding devices.
- Apply rust inhibitive lubricant to all non-painted surfaces.



Note: *Proper maintenance can increase the life expectancy of your machine.*

- Check all fasteners to make sure they are tight and check all adjustments that they are in order.
- Clean and oil the tables so that the material will slide easily. Clean any rust spots that may develop on the bed with a commercial rust remover.
- Use compressed air to blow out the interior of the machine in order to keep chips and sawdust from accumulating on the belts and pulleys.
- Check the drive belt for tightness. It should be snug but not overly tight.
- Use a mill file to remove any nicks or dings from the infeed or outfeed tables.
- Clean out-feed rollers and table with a nonflammable solvent to remove pitch, gum and other unwanted build-up.
- Keep pulleys and belts free from dirt, dust, oil and grease. Replace worn V-belts as needed.
- There are three limit switches on the planer, one that triggers if the hood is open, and a raising and a lowering limit switch to prevent the table from automatically traveling too far. Keep these clean and blown out with an air hose.



LUBRICATION

- Add a few drops of medium weight oil to the six oil cups (A, Fig 25) weekly.
- Lubricate the two table elevation screws (B, Fig 26) as needed. Raise the table and remove the two screws holding the top of the accordion cover (C, Fig 26) in place. Pull the cover down and lightly grease the elevating screws, see Figure 26.
- Use an oiled cloth to wipe the ways (D, Fig 26) weekly.
- Lubricate the chain system with an oiled cloth as needed.
- The gear box oil should be changed once a year. Remove the drain plug (E, Fig 27) to drain the oil. Refill the gear box with 60-90 weight gear oil through the fill hole (F, Fig 27) until the sight glass (G, Fig 27) reads full. The sight glass (G, Fig 27) should be checked periodically and oil added as necessary.

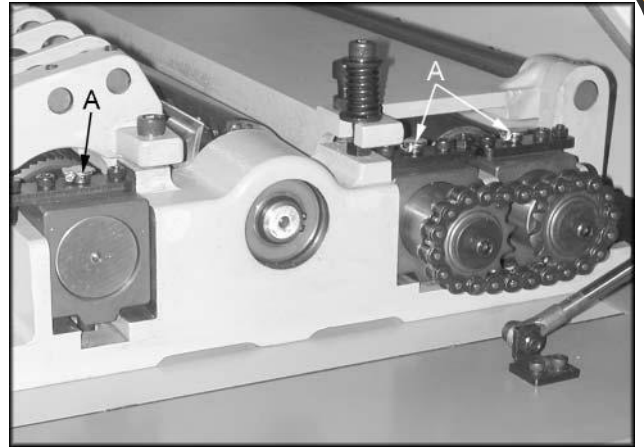

Figure 25

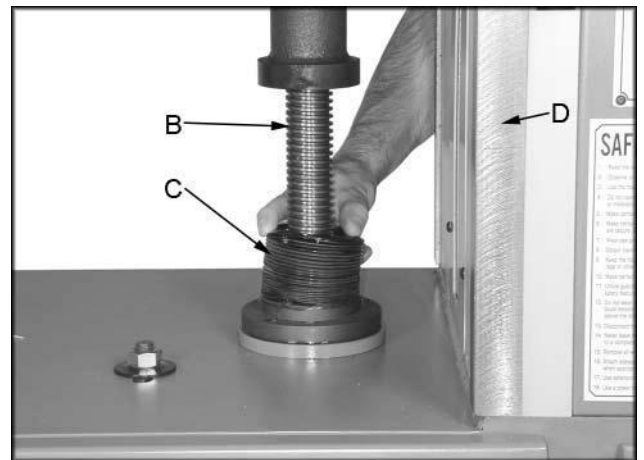

Figure 26

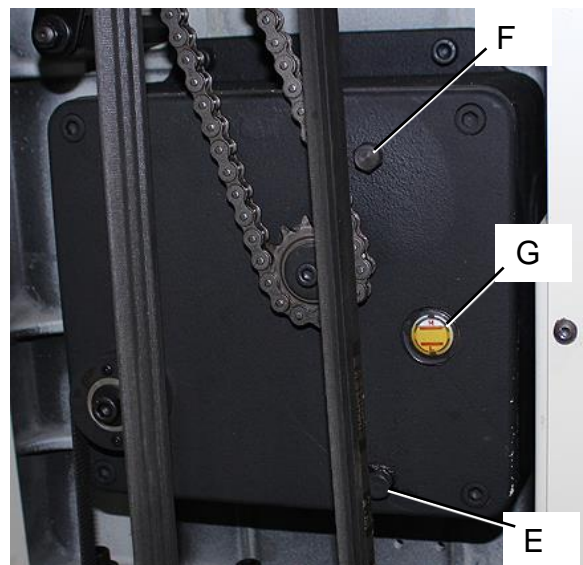

Figure 27



TROUBLESHOOTING: PLANER OPERATING



WARNING: Make sure the electrical disconnect is OFF before working on the machine.

Maintenance should be performed on a regular basis by qualified personnel.

Always follow proper safety precautions when working on or around any machinery.

Trouble	Probable Cause	Remedy
Snipe.	Table rollers not set properly.	Adjust table rollers to proper height.
	Inadequate support of long boards.	Support long boards with a roller stand.
	Uneven feed roller pressure front to back.	Adjust feed roller tension.
	Dull knife inserts.	Rotate or replace knife inserts.
	Lumber not butted properly.	Butt end-to-end each piece of stock as they pass through.
Fuzzy grain.	Planing wood with a high moisture content.	Remove high moisture content from wood by drying, or use different stock.
	Dull knife inserts.	Rotate or replace knife inserts.
Torn grain.	Too heavy a cut.	Adjust proper depth of cut.
	Knife inserts cutting against grain.	Try to cut with the grain for finish cut.
	Dull knife inserts.	Rotate or replace knife inserts.
Rough/raised grain.	Dull knife inserts.	Rotate or replace knife inserts.
	Excessive depth of cut.	Decrease cutting depth.
	Moisture content too high.	Remove high moisture content from wood by drying, or use different stock.
Rounded, glossy surface.	Dull knife inserts.	Rotate or replace knife inserts.
Poor feeding of lumber.	Inadequate feed roller pressure.	Adjust feed roller tension. If proper tension cannot be achieved, replace feed rollers.
	Planer bed rough or dirty.	Clean off pitch and residue; apply light coat of paste wax to planer bed.
	V-belts are slipping.	Check V-belt tension and make any needed adjustments.
	Surface of feed rollers has been worn too smooth.	Lightly roughen the feed roller surface with sandpaper.



TROUBLESHOOTING: MECHANICAL AND ELECTRICAL

Trouble	Probable Cause	Remedy
Uneven depth of cut side to side.	Knife inserts not set correctly.	Make sure knife inserts are set correctly and securely in cutterhead.
	Planer table not level with cutterhead.	Level the table.
Board thickness does not match depth of cut scale.	Depth of cut scale is incorrect.	Adjust depth of cut scale. Use LED control panel for greater precision.
Chain is jumping.	Inadequate chain tension.	Adjust chain tension.
	Sprockets misaligned.	Align sprockets.
	Sprockets worn.	Replace sprockets.
Machine will not start/restart or repeatedly trips circuit breaker or blows fuses.	No incoming power.	Verify machine is connected to power.
	Stop button is still engaged.	Rotate stop button to disengage.
	Overload automatic reset has not reset.	Allow machine to adequately cool before attempting restart. If problem persists, check amp setting on the motor starter inside the electrical box.
	Planer frequently trips.	Too deep a cut. Take a lighter cut. Check the amp setting on the overload relay. Match the full load amps on the motor as noted on the motor plate. Loose electrical lead or a failed component.
	Building circuit breaker trips or fuse blows.	Verify that planer is on a circuit of correct size. If circuit size is correct, there is probably a loose electrical lead. Check amp setting on motor starter.
	Loose electrical connections.	Go through all of the electrical connections on the planer including motor connections, verifying the tightness of each. Look for any signs of electrical arcing which is a sure indicator of loose connections or circuit overload.



Trouble	Probable Cause	Remedy
Machine will not start/restart or repeatedly trips circuit breaker or blows fuses.	Motor starter failure.	Examine motor starter for burned or failed components. If damage is found, replace motor starter. If motor starter looks okay but is still suspect, you have two options: have a qualified electrician test the motor starter for function, or purchase a new starter and establish if that was the problem on change out. If you have access to a voltmeter, you can separate a starter failure from a motor failure by first, verifying incoming voltage at 220+/-20 and second, checking the voltage between starter and motor at 220+/-20. If incoming voltage is incorrect, you have a power supply problem. If voltage between starter and motor is incorrect, you have a starter problem. If voltage between starter and motor is correct, you have a motor problem.
	Motor failure.	If electric motor is suspect, you have two options: Have a qualified electrician test the motor for function or remove the motor and take it to a quality electrical motor repair shop and have it tested.
	Miswiring of the machine.	Double check to confirm all electrical connections are correct. Refer to wiring diagram to make any needed corrections.
	Switch failure.	If a start, stop, or table movement switch is suspect, you have two options: Have a qualified electrical test the switch for function, or purchase a new switch and establish it that was the problem on change out.
Planer does not come up to speed.	Low current.	Contact a qualified electrician.



ELECTRICAL SCHEMATIC

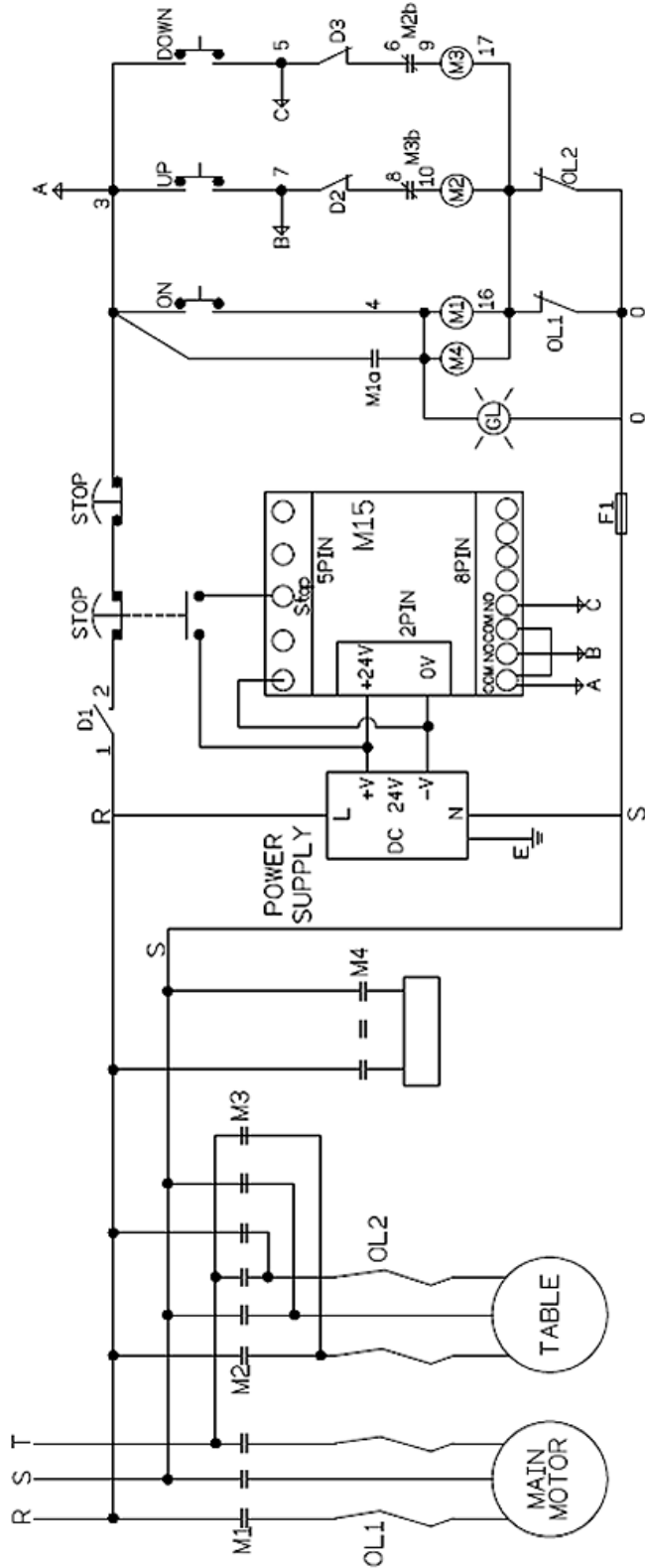



PARTS DIAGRAM

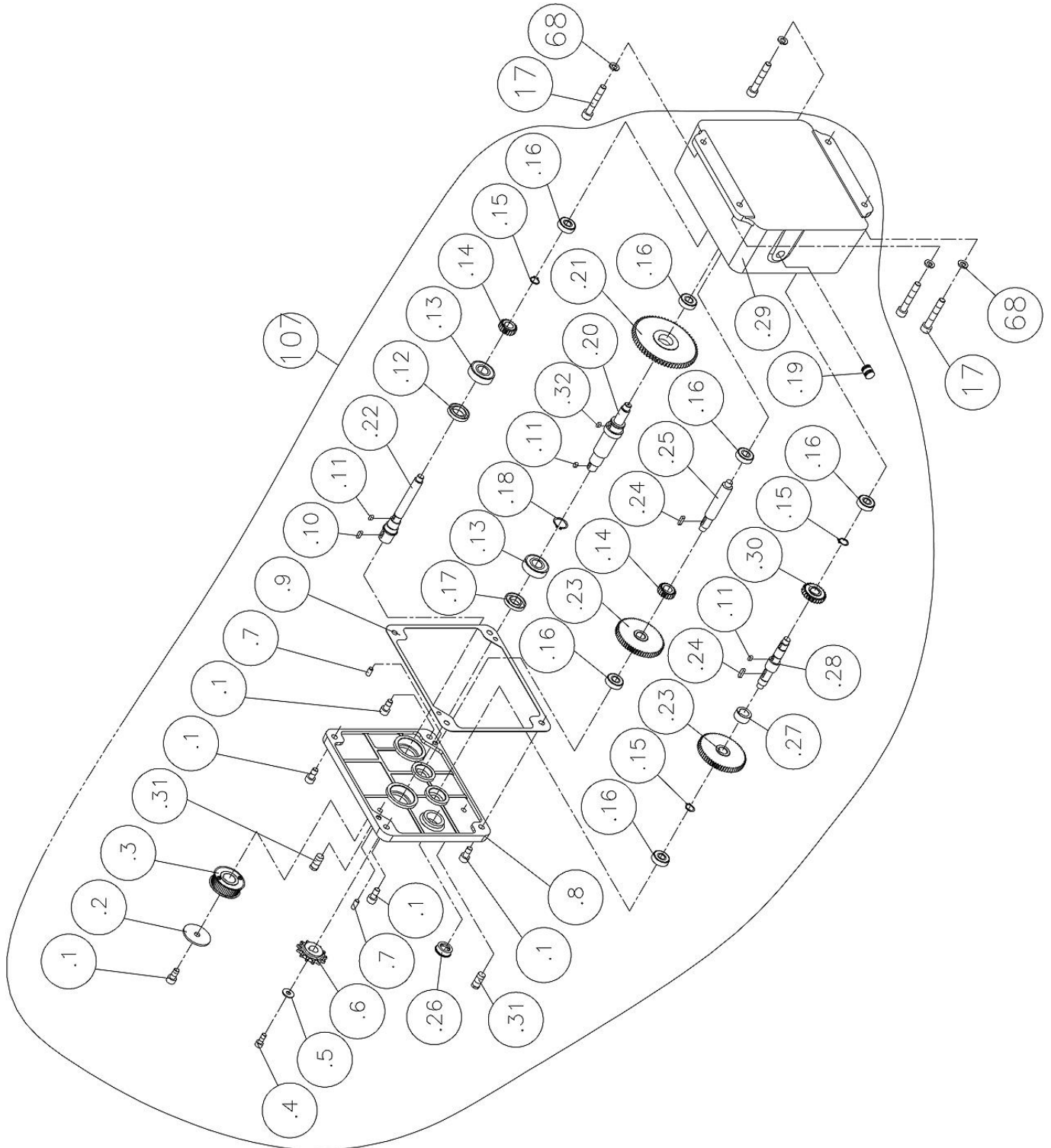

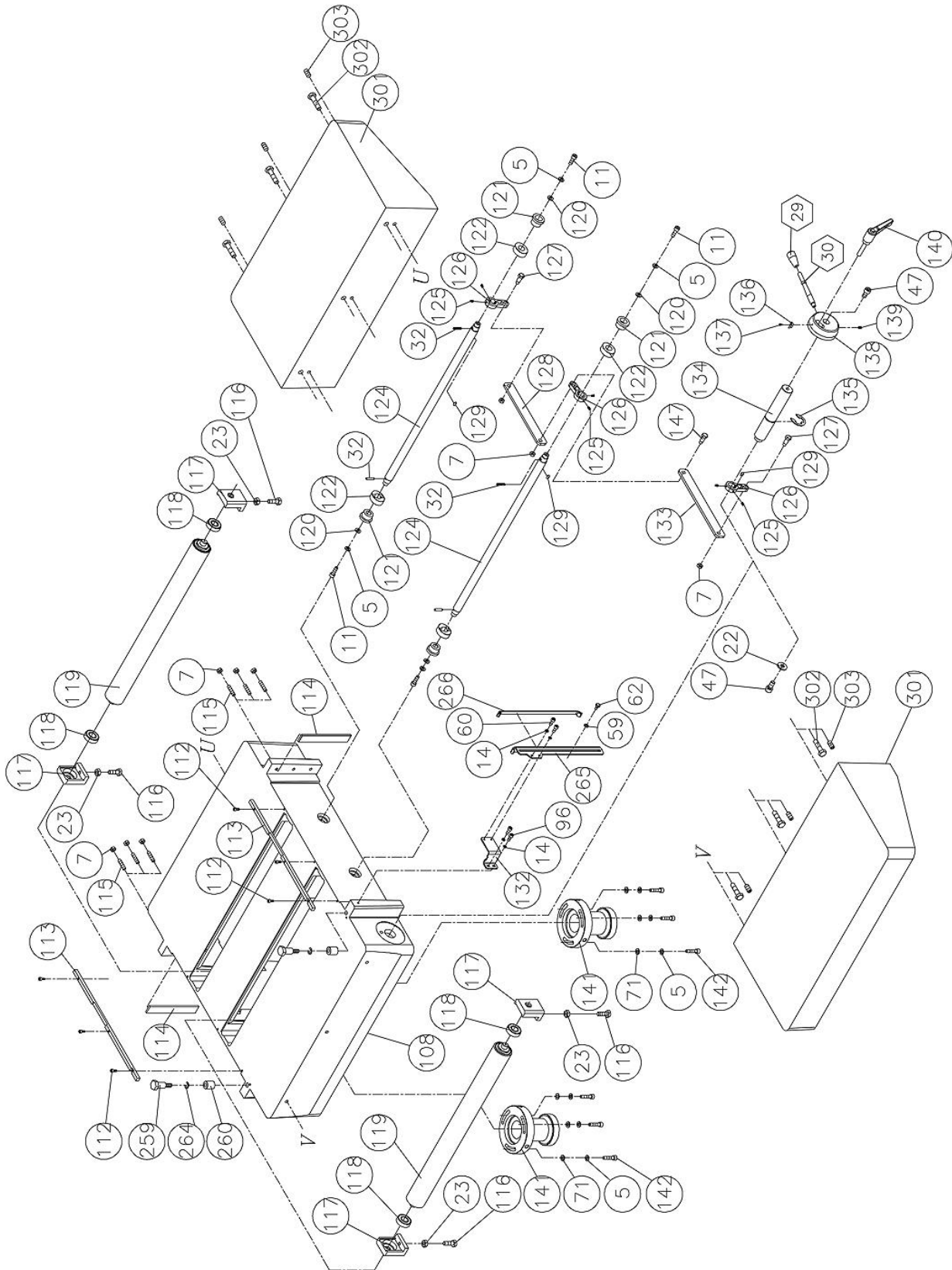

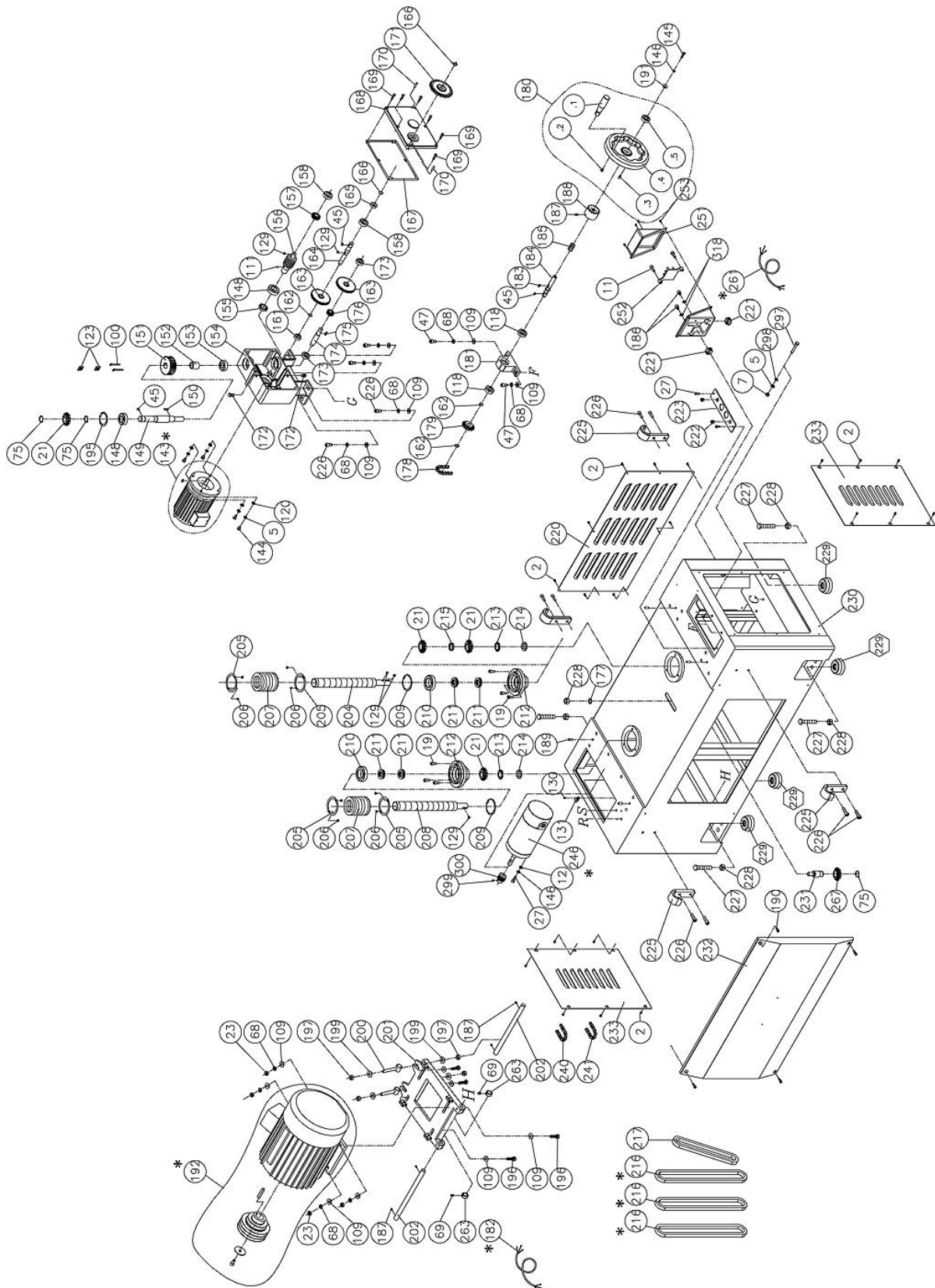

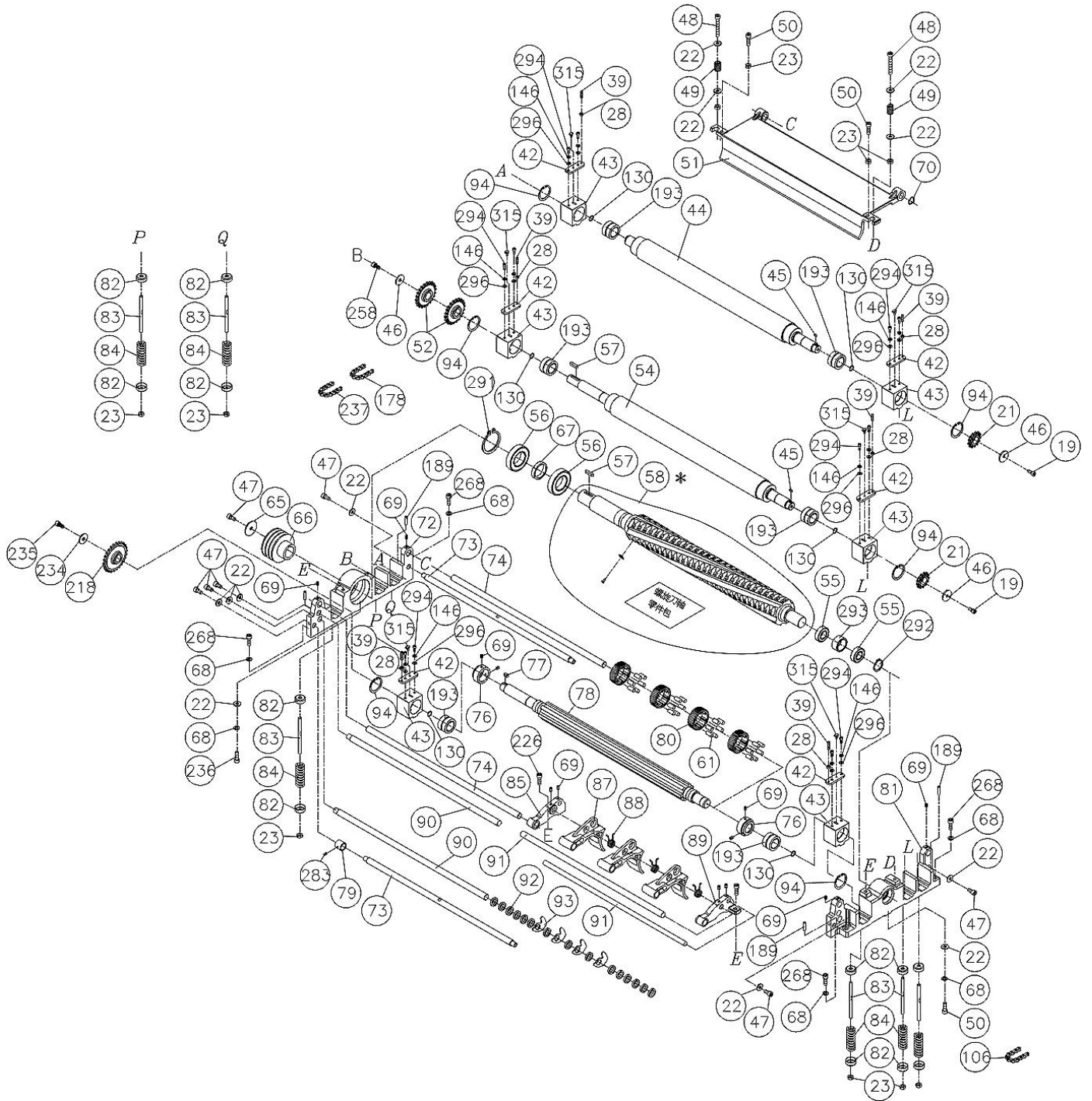

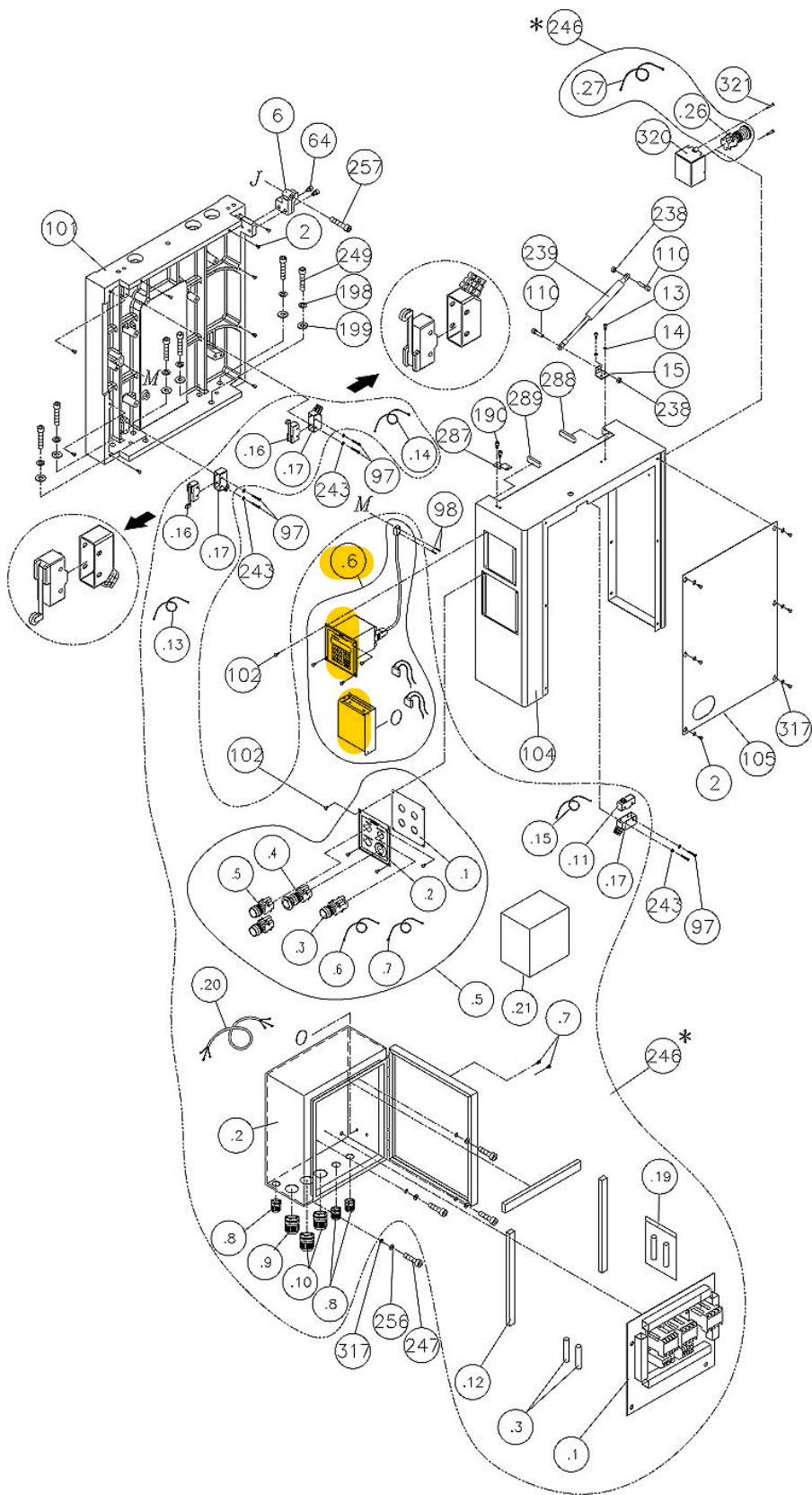

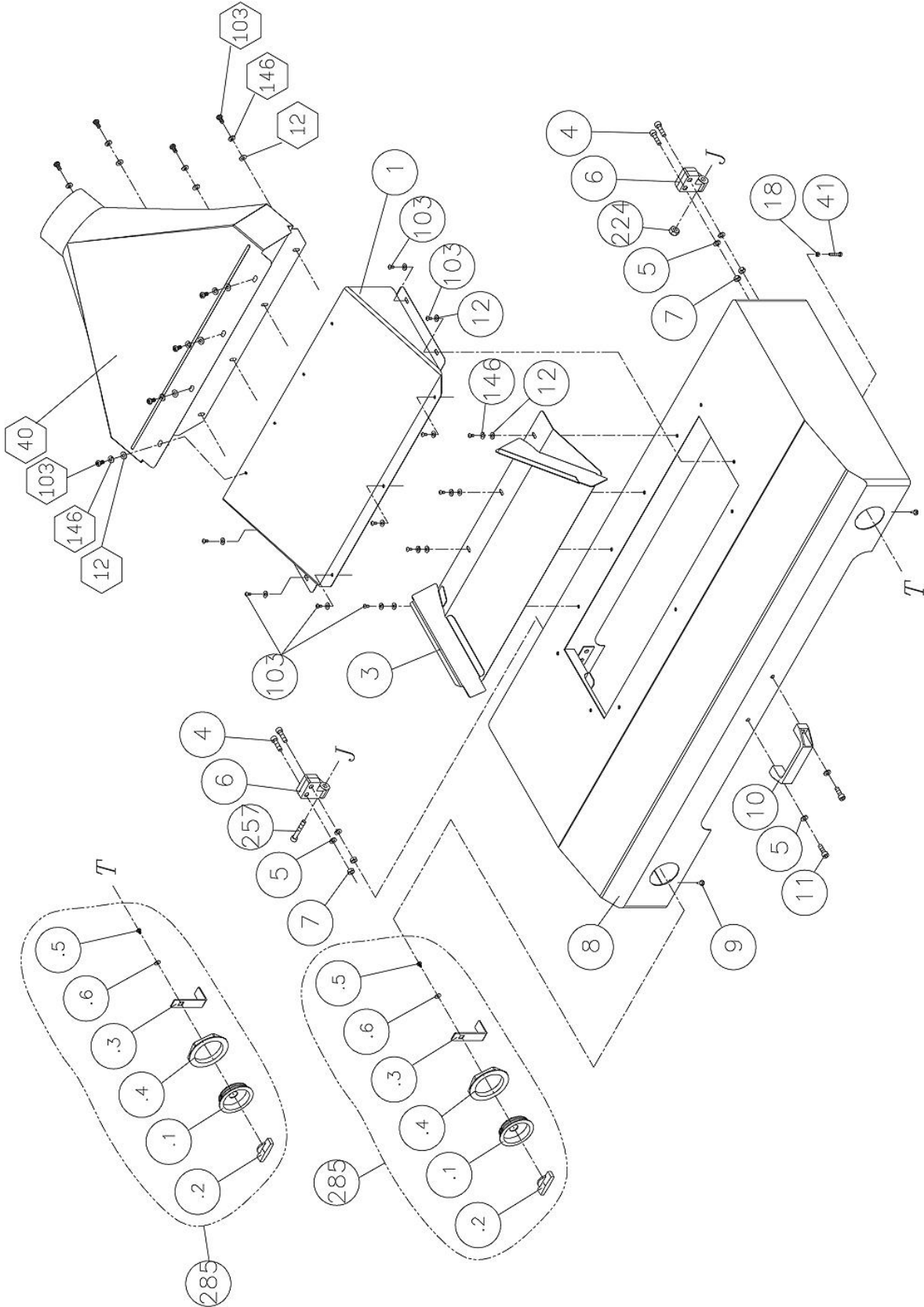

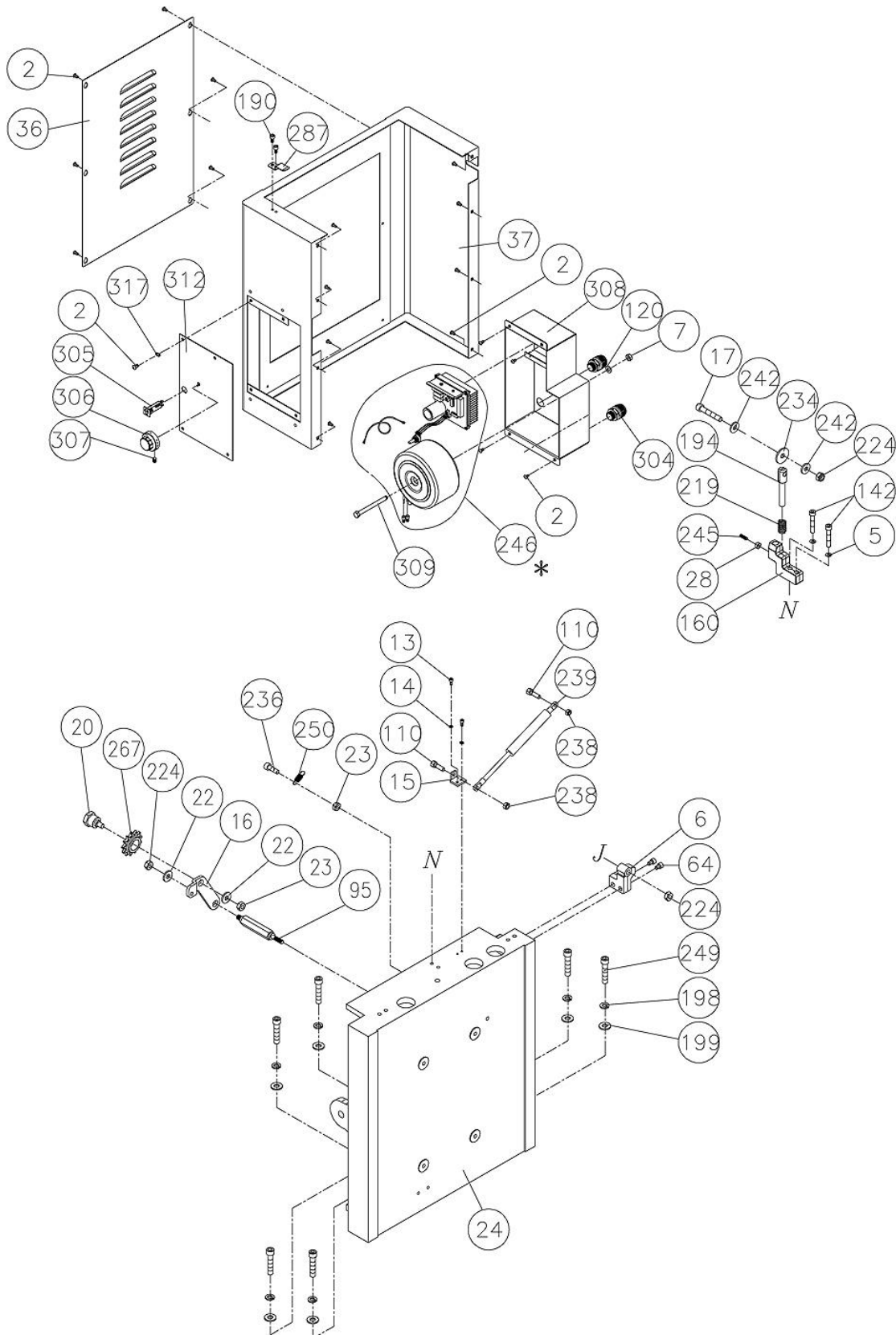



Parts List

Item	Part No.	Description	Specification	Qty.
1	171398-000	Upper Cover		1
2	000801-101	Socket Head Button Screw	M6*1.0P*10	57
3	171393-000	Deflection Plate		1
4	000104-110	Socket Head Cap Screw	M8*1.25P*30	4
5	006305-100	Spring Washer	8.2*15.4	23
6	050320-000	Upper Cover Housing		4
7	008006-100	Hex Nut	M8*1.25P (13B*6.5H)	15
8	171559-000	Top Cover		1
9	340007-615	Bumper		2
10	250123-615	Handle		1
11	000104-108	Socket Head Cap Screw	M8*1.25P*25	8
12	006001-022	Flat Washer	6.3*13*1.0t	15
13	000102-104	Socket Head Cap Screw	M5*0.8P*12	4
14	006302-100	Spring Washer	5.1*9.3	8
15	170893-901	Washer		2
16	170501-904	Idler Shaft		1
17	000105-104	Socket Head Cap Screw	M10*1.5P*35	5
18	008004-100	Hex Nut	M5*0.8P (8B*4H)	1
19	000104-106	Socket Head Cap Screw	M8*1.25P*20	8
20	290040-901	Idler Shaft		1
21	380259-000	Sprocket		6
22	006001-071	Flat Washer	10*25*3.0t	15
23	008007-100	Hex Nut	M10*1.5P (17B*8H)	20
24	050580-000	Left Column		1
27	000103-106	Socket Head Cap Screw	M6*1.0P*16	6
28	008005-100	Hex Nut	M6*1.0P (10B*5H)	7
29	250054-615	Grip		1
30	360414-910	Grip Shaft		1
36	170895-000	Left Plate		1
37	173211-000	Lift Side Plate		1
39	000203-109	Set Screw	M6*1.0P*30	6
40	174338-000	Collector Hood		1
41	000001-103	Hex Cap Screw	M5*0.8P*25	1



Item	Part No.	Description	Specification	Qty.
42	173879-902	Adjust Block		6
43	051267-902	Bearing Housing		6
44	360196-000	Rear Outfeed Roller		1
45	012003-003	Key	5*5*12	5
46	170002-901	Washer		3
47	000105-101	Socket Head Cap Screw	M10*1.5P*20	11
48	000105-109	Socket Head Cap Screw	M10*1.5P*75	2
49	280056-901	Spring		2
50	000105-105	Socket Head Cap Screw	M10*1.5P*40	3
51	050455-000	Rear Press Plate		1
52	070019-902	Sprocket		2
54	360189-000	Roller Long Rear		1
55	030202-002	Bearing	6007	2
56	030219-002	Bearing	6210	2
57	012005-003	Key	8*7*35	2
58	923677-000	Helical Head Assembly		1
58.A	038201-702	Dish Inner Star Screw	#10-32UNF*12.5 phosphate	145
58.B	210114-000	Insert Blade	15 * 15 * 2.5t	145
58.2	850586-000	Replacement Blade Parts Kit		1
	040703-000	T-type star plate Hand	T-25	2
	038201-702	Dish Inner Star Screw - Set	#10-32UNF * 12.5 phosphate	10
	210114-000	Insert Blade - Set	15 * 15 * 2.5t	10
59	006701-100	Wavy Washer	WW-6	1
60	002603-101	Cap Lock Screw	M5*0.8P*10	2
61	250352-615	Rubber Pin		144
62	290055-901	Special Screw		1
64	000104-111	Socket Head Cap Screw	M8*1.25P*35	4
65	006001-084	Flat Washer	11*53*3.0t	1
66	050464-902	Pulley		1
67	190151-902	Bushing		1
68	006307-100	Spring Washer	10.2*18.5	20
69	000204-102	Set Screw	M8*1.25P*10	14
70	006712-100	Wavy Washer	BWW-6001	1
71	006001-056	Flat Washer	8.5*23*2.0t	6
72	050881-000	Left Cutterhead Bracket		1



Item	Part No.	Description	Specification	Qty.
73	360624-902	Cutterhead Base Support Shaft		2
74	360629-902	Press Shaft		2
75	010011-000	S-Ring	STW-25	3
76	380470-902	Front Roller Spacer		2
77	012005-006	Key	8*7*16	1
78	360506-000	Front Roller Shaft		1
79	190051-902	Shaft		1
80	130052-903	Front Outfeed Roller		24
81	050880-000	Right Cutterhead Bracket		1
82	170512-901	Fix Washer		12
83	360408-902	Shaft		6
84	280055-901	Spring		6
85	050462-000	Left Press Plate Seat		1
87	050305-000	Front Press Plate		11
88	280053-000	Turn Spring		11
89	050463-000	Right Press Plate Seat		1
90	360627-902	Cutterhead Base Support Shaft		2
91	360632-902	Cutterhead Base Support Shaft		2
92	250160-615	Spacer		79
93	172281-905	Anti-Kickback Pawl		70
94	010107-000	R-Ring	RTW-47	6
95	380388-902	Hex Screw		1
96	000102-103	Socket Head Cap Screw	M5*0.8P*10	2
97	000302-210	Round Head Screw	M4*0.7P*30	6
98	000301-204	Round Head Screw	M5*0.8P*15	2
99	041305-004	Plastic Bag	275*195 (Opening)*0.1t	2
100	021002-000	Band	ALT-250M	2
101	050575-000	Right Column		1
102	000302-103	Round Head Screw	M4*0.7P*10	8
103	002501-102	Button Head Screw	M6*1.0P*12L	11
104	174339-000	Right Side Plate		1
105	171401-000	Right Plate		1
106	016001-000	Chain	#40*24P	1



Item	Part No.	Description	Specification	Qty.
107	923250-000	Gear Box Assembly		1
107.1	000105-101	Socket Head Cap Screw	M10*1.5P*20	5
107.2	006001-071	Flat Washer	10*25*3.0t	1
107.3	923207-000	Belt Pulley Assembly		1
	300053-000	Gear Box Pulley		1
	173212-902	Pulley Cover		1
107.4	000104-106	Socket Head Cap Screw	M8*1.25P*20	1
107.5	006001-056	Flat Washer	8.5*23*2.0t	1
107.6	320310-902	Sprocket		1
107.7	011106-101	Pin	8*18	2
107.8	050467-008	Gearbox Cover		1
107.9	340050-000	Oil Seal		1
107.10	012003-005	Key	5*5*16	1
107.11	012003-002	Key	5*5*10	3
107.12	043605-000	Oil Seal	TC24*40*7	1
107.13	030208-002	Bearing	6204	2
107.14	320208-000	Gear 20t		2
107.15	010007-000	S-Ring	STW-16	3
107.16	030205-002	Bearing	6201	6
107.17	043603-000	Oil Seal	TC20*40*7	1
107.18	010011-000	S-Ring	STW-25	1
107.19	381082-000	Plug		1
107.20	361005-000	Shaft		1
107.21	320316-000	Gear		1
107.22	360646-000	Shaft		1
107.23	320209-000	Gear 60t		2
107.24	012003-007	Key	5*5*20	2
107.25	360647-000	Shaft		1
107.26	043001-000	Oil Level Sight Glass	29	1
107.27	381073-000	Bushing		1
107.28	360648-000	Shaft		1
107.29	050466-008	Gear Box		1
107.30	320211-000	Gear 24t		1
107.31	043401-000	Oil Plug	PT1/4"-19	2
107.32	012003-001	Key	5*5*8	1



Item	Part No.	Description	Specification	Qty.
108	050774-000	Middle Table		1
109	006001-075	Flat Washer	10.3*22*2.0t	14
110	290024-901	Screw		4
111	001903-104	Screw Set	M8*1.25P*10	1
112	000102-105	Socket Head Cap Screw	M5*0.8P*16	6
113	171818-902	Guide Plate		2
114	170498-901	Plate		2
115	000204-109	Set Screw	M8*1.25P*40	6
116	000004-103	Hex Cap Screw	M10*1.5P*30	4
117	130049-903	Roller Bracket		4
118	030207-002	Bearing	6203	6
119	920669-000	Roller Assembly		2
119.1	190053-000	Roller		1
119.2	360426-000	Roller Shaft		2
120	006001-049	Flat Washer	8.5*16*2.0t	8
121	360419-901	Shaft		4
122	130050-000	Up/Down Cam		4
123	023301-000	Fixing Plate	AAM-20	2
124	360636-902	Shaft		2
125	000202-102	Set Screw	M5*0.8P*8	6
126	130048-903	Connect Plate		3
127	290016-901	Special Screw		2
128	170900-902	Rear Linking Plate		1
129	012003-002	Key	5*5*10	8
130	010501-000	Retainer Ring	ISTW-30	6
131	040003-000	Hexagonal (Allen) Wrench	3mm	1
132	171396-156	Pointer		1
133	170899-902	Front Linking Plate		1
134	360420-902	Shaft		1
135	010211-000	E-Ring	ETW-24	1
138	050313-902	Rod Seat		1
139	000203-102	Set Screw	M6*1.0P*8	1
140	230122-000	Universal Handle		1
141	050318-902	Bolt Shaft		2
142	000104-112	Socket Head Cap Screw	M8*1.25P*40	8



Item	Part No.	Description	Specification	Qty.
143	596136-000	Motor Assembly	1/2HP*230V*60HZ*3PH*4P	1
143.1	012202-004	Woodruff Key	5*5*20	1
144	000003-105	Hex Cap Screw	M8*1.25P*25	4
145	000103-107	Socket Head Cap Screw	M6*1.0P*20	1
146	006303-100	Spring Washer	6.1*12.3	21
147	290015-901	Special Screw		1
148	030116-002	Bearing	6205	2
149	360642-000	Shaft		1
150	012003-008	Key	5*5*22	1
151	320248-000	Gear		1
152	190085-901	Bushing		1
153	030109-002	Bearing	6204	1
154	050461-008	Gearbox		1
155	043607-000	Oil Seal	TC25*40*8	1
156	360641-000	Worm		1
157	320247-000	Gear 24t		1
158	030108-002	Bearing	6203	2
159	040004-000	Hexagonal (Allen) Wrench	4mm	1
160	050574-008	Idler Holder		1
161	030106-002	Bearing	6201	1
162	010007-000	S-Ring	STW-16	3
163	320209-000	Gear 60t		2
164	360640-000	Shaft		1
165	043501-000	Oil Seal	SC17*30*8	1
166	010008-000	S-Ring	STW-17	2
167	340049-000	Oil Seal		1
168	050459-008	Gearbox Cover		1
169	000103-108	Socket Head Cap Screw	M6*1.0P*25	6
170	011104-105	Pin	6.0*25	2
171	320245-000	Sprocket		1
172	043401-000	Oil Plug	PT1/4"-19	2
173	030107-002	Bearing	6202	2
174	360643-000	Shaft		1
175	012003-007	Key	5*5*20	1
176	320208-000	Gear 20t		1



Item	Part No.	Description	Specification	Qty.
177	006001-101	Flat Washer	16*25*1.5t	1
178	016009-000	Chain	#40*58P	2
179	320310-902	Sprocket		1
180	920372-000	Hand Wheel Assembly		1
180.1	230046-000	Handle		1
180.2	000702-102	Socket Hex Screw	M6*1.0P*12	1
180.3	011106-101	Pin	8*18	1
180.4	240033-000	Handle Wheel		1
180.5	030103-001	Bearing	6004	1
181	050458-902	Housing		1
182	923453-000	Motor Cord	3PH (35-44A)	1
183	012003-004	Key	5*5*15	1
184	360631-000	Hand Wheel Shaft		1
185	280091-000	Spring		1
186	000104-103	Socket Head Cap Screw	M8*1.25P*12	2
187	000203-106	Set Screw	M6*1.0P*16	5
188	380226-902	Bushing		1
189	360413-901	Pin		8
190	000103-102	Socket Head Cap Screw	M6*1.0P*10	8
191	006001-021	Flat Washer	6.2*22*3t	1
192	901070-000	Motor Assembly	15HP*230V*60HZ*3PH*2P	1
192.1	000105-101	Cap Screw	M10 * 1.5P * 20 Black	1
192.2	006001-084	Flat Washer	11 * 53 * 3.0t Black	1
192.3	012205-001	Single Round Key	10 * 8 * 56	1
192.4	050465-902	Motor Pulley		1
193	032101-002	Bearing	NA-6906	6
194	360155-902	Idler Shaft		1
195	010108-000	R-Ring	RTW-52	1
196	000004-306	Hex Cap Screw	M10*1.5P*50	4
197	008009-100	Hex Nut	M12*1.75P (19B*10H)	4
198	006308-100	Spring Washer	12.2*21.6	12
199	006001-091	Flat Washer	13*28*3.0t	16
200	380249-901	Adjustment Rod		2
201	050368-008	Motor Plate		1
202	360270-902	Shaft		2



Item	Part No.	Description	Specification	Qty.
203	940698-000	Manual	Baileigh (IP-2509-HD-3)	1
204	360634-000	Lock Bolt		1
205	170481-901	Collar		4
206	001601-101	Screw With Washer	M4*0.7P*8/4*10*0.8t	8
207	250173-615	Expansion Bend		2
208	360423-000	Lock Bolt		1
209	010110-000	R-Ring	RTW-68	2
210	030203-002	Bearing	6008	2
211	031003-001	Bearing	51105	4
212	050662-902	Bushing Nut		2
213	006802-100	Washer	25	2
214	008201-100	Bushing Nut	M25*1.5P	2
215	190084-902	Washer		1
216	014110-000	V-Belt	A86 (60HZ)	1
217	015201-000	Gear Pulley	3GT-750-15	1
218	070017-902	Sprocket		1
219	280067-901	Spring		1
220	170897-000	Rear Cover		1
221	021802-000	Strain Relief	NB-2430	2
222	021805-000	Strain Relief	NB-1216	2
223	170894-008	Wiring Board		1
224	008308-100	Lock Nut	M10*1.5P (17B*12H)	4
225	170638-156	Hanger		4
226	000105-103	Socket Head Cap Screw	M10*1.5P*30	14
227	000006-206	Hex Cap Screw	M16*2.0P*55L	4
228	008011-200	Hex Nut	M16*2.0P (24B*13H)	5
229	050314-008	Foot Pad		4
230	173210-000	Cover		1
231	360693-902	Idler Shaft		1
232	172728-000	Front Cover		1
233	170892-000	Side Cover		2
234	006001-083	Flat Washer	11*37*3.0t	2
235	001302-101	Socket Head Cap Screw	M10*1.5P*20	1
236	000105-112	Socket Head Cap Screw	M10*1.5P*45	2
237	016010-000	Chain	#40*74P	1



Item	Part No.	Description	Specification	Qty.
238	008306-100	Lock Nut	M8*1.25P(13B*9H)	4
239	230276-000	Cylinder	15kg	2
240	016002-000	Chain	#40*54P	1
241	016012-000	Chain	#40*84P	1
242	006003-079	Flat Washer	10.5*19*2.0t	2
243	006001-003	Flat Washer	4.3*12*1.0t	6
245	000203-107	Set Screw	M6*1.0P*20	1
246	937875-000	Switch Assembly	15hp*230V*60hz*3ph*2P*CSA	1
247	000103-103	Socket Head Cap Screw	M6*1.0P*12	4
249	000106-102	Socket Head Cap Screw	M12*1.75P*40	12
250	280098-000	Spring		1
251	490126-008	External Box		1
252	490127-000	Terminal Plate		1
253	000303-103	Round Head Screw	M5*0.8P*10	4
256	006001-034	Flat Washer	6.7*16*2.0t	4
257	000004-107	Hex Cap Screw	M10*1.5P*70	2
258	001301-101	Socket Head Cap Screw	M8*1.25P*20	1
259	290009-902	Shoulder Screw		2
260	190002-905	Position Point		2
261	924162-000	Power Cord	3PH (35-44A)	1
262	041306-002	Plastic Bag	190*130 (Opening)*0.15t	
263	190074-901	Collar		2
264	010205-000	E-Ring	ETW-8	2
265	171399-902	Slide Bracket		1
266	921133-000	Magnetic Bar Assembly		1
267	150001-000	Idler		2
268	000105-107	Socket Head Cap Screw	M10*1.5P*50	4
274	945862-000	Nameplate	Baileigh (CSA)	1
275	040005-000	Hexagonal (Allen) Wrench	5mm	1
276	040007-000	Hexagonal (Allen) Wrench	8mm	1
277	040204-000	Open-End Wrench	12*14	1
278	040206-000	Open-End Wrench	17*19	1
279	040207-000	Open-End Wrench	22*24	1
280	040401-000	Screw Driver	No. 1*75	1
281	041001-001	Zipper Bag	60*40*0.05	1



Item	Part No.	Description	Specification	Qty.
283	000201-101	Set Screw	M4*0.7P*6	1
285	920664-000	Adjust Knob		2
287	171151-902	Fix Washer		2
291	010118-000	R-Ring	RTW-90	1
292	010109-000	R-Ring	RTW-62	1
293	380787-902	Collar		1
294	002602-102	Cap Lock Screw	M6*1.0P*20	12
296	006001-023	Flat Washer	6.3*13*2.0t	12
297	000003-110	Hex Cap Screw	M8*1.25P*50	1
298	006001-046	Flat Washer	8.5*16*1.5t	1
299	000202-101	Set Screw	M5*0.8P*5	1
300	300052-000	Pulley		1
301	050775-000	Extension Roller Assembly		2
302	000005-102	Hex Cap Screw	M12*1.75P*50	6
303	000205-103	Set Screw	M10*1.5P*20	6
304	021335-000	Relief Bushing	MG20A-14B	1
305	490508-000	Overload	10AMP-	1
306	922316-000	Handwheel Assembly		1
307	001904-102	Screw Set	M4*0.7P*4	1
308	173213-000	Bracket		1
309	000003-218	Hex Cap Screw	M8*1.25P*90	1
310	000302-102	Round Head Screw	M4*0.7P*8	1
312	173377-000	Cover Plate		1
315	044302-301	Oil Cup	3/16"	6
317	006503-100	External Tooth Lock Washer	6.4*11 (BW-6)	14
318	006504-100	External Tooth Lock Washer	8.4*15 (BW-8)	2
319	021003-000	Band	ALT-150M	2
320	250479-615	Switch Box		1
321	000805-102	Socket Head Button Screw	M4*0.7P*10	2



NOTES



BAILEIGH INDUSTRIAL, INC. 1625 DUFEEK DRIVE MANITOWOC, WI 54220

PHONE: 920. 684. 4990 FAX: 920. 684. 3944

WWW.BAILEIGH.COM

BAILEIGH INDUSTRIAL, INC. 1455 S. CAMPUS AVENUE ONTARIO, CA 91761

PHONE: 920. 684. 4990 FAX: 920. 684. 3944

BAILEIGH INDUSTRIAL LTD. UNIT 1 FULLWOOD CLOSE

SWIFT VALLEY INDUSTRIAL ESTATE, RUGBY

WEST MIDLANDS, CV21 1QH UNITED KINGDOM

PHONE: +44 (0)24 7661 9267 FAX: +44 (0)24 7661 9276

WWW.BAILEIGH.CO.UK

BAILEIGH INDUSTRIAL GMBH HOFENER STRASSE 64

70736 FELLBACH, DEUTCHSLAND

PHONE: +49 (0)711 342 48 168 FAX: +49 (0)711 508 9028

WWW.BAILEIGH.DE

BAILEIGH INDUSTRIAL PTY. LTD.

P.O Box 1573, 126 MELROSE DRIVE TULLAMARINE,

VIC 3043 AUSTRALIA

PHONE: 61.383.743.888

WWW.BAILEIGH.COM.AU