

# Safety - Installation - Operation - Maintenance Stratus Commercial Grade On-Ground or In-Ground Mount Low Profile Full Rise Scissor Car Lift SAE-UT9000

Model: UT9000



Manual SAE-UT9000— Revision A1 — June 2024

## IMPORTANT NOTE:

1. Save these instructions!
2. This equipment should not be installed, operated or repaired without first reading the instructions. Failure to follow the instructions and safety can result in serious injury or death.
3. Electricity should be hooked up by a certified electrician.
4. Do NOT use equipment beyond its rated capacity.
5. Keep manual near lift for reference
6. By proceeding with installation and operation, you agree that you fully understand the contents of this manual and assume full responsibility for product use.
7. Only Operate this lift if it can be done so safely.

# Introduction

This manual is designed to help customers use Stratus UT9000 scissor lift. This is a mid rise, with an open center that provides full under vehicle access.

This lift comes with a capacity of 9,000 LBS.

Stratus recommends keeping this manual within reach of the lift for anyone who is to use or service the machine. Frequently asked questions and Troubleshooting steps have been included within this manual. If you have any questions and/or issues which are not answered here, please contact us at **512-640-9896** or email [support@stratusautoequip.com](mailto:support@stratusautoequip.com)

# Symbols

Following are the symbols used in this manual:

 **DANGER** Calls attention to an immediate hazard that will result in injury or death.

 **WARNING** Calls attention to a hazard or unsafe practice that could result in injury or death.

 **CAUTION** Calls attention to a hazard or unsafe practice that could result in minor personal injury, product, or property damage.

**NOTICE** Calls attention to a situation that, if not avoided, could result in product or property damage.

 **Tip** Calls attention to information that can help you use your product better.

# Liability

Stratus Auto Equipment assumes no liability for damages resulting from:

- Use of the product for purposes other than those described in this manual.
- Modifications to the equipment without prior, written permission from Stratus Auto Equipment
- Injury or death caused by modifying, disabling, overriding, or removing safety features.
- Damage to the equipment from external influences.
- Incorrect or improper operation of the equipment.

**Manual** - UT9000 - On-Ground or In-Ground Mount Low Profile Full Rise Scissor Car Lift - Safety - Installation - Operation - Maintenance

**Copyright** - Copyright © 2023 by Stratus Metals, Inc. dba Stratus Auto Equipment reserves all rights. Copies may be made of this document if you agree full attribution to Stratus Metals Inc. Changes and Copies for commercial purposes to this document are prohibited.

**Trademarks**- Stratus Auto Equipment and logo are registered trademarks of Stratus Metals, Inc. All other company, product, and service names are used for identification only. All trademarks and registered trademarks mentioned in this manual are the property of their respective owners.

**Limitations**- Whereas every effort has been made to ensure this manual has complete and accurate information; Product updates, revisions, and/or changes could have occurred since this manual was written and published. Stratus Auto Equipment reserves the right to change any information in this manual without incurring any obligation for equipment previously or subsequently sold. Stratus Auto Equipment is not responsible for typographical errors in this manual.

**Safety**- Your product was designed and manufactured with safety in mind. However, your safety also depends on proper training and thoughtful operation. Do not install, operate, maintain, or repair the unit without reading and understanding this manual and the labels on the unit; *do not use your Lift unless you can do so safely!*

**Owner Responsibility**- In order to ensure operator safety and maintain your product properly, it is the responsibility of the product owner to read and follow these instructions:

- Follow all setup, operation, and maintenance instructions.
- Make sure product setup and use conforms to all applicable local, state, and federal codes, rules, and regulations, such as state and federal OSHA regulations and electrical codes.
- Read and follow all safety instructions. Keep them readily available for operators.
- Make sure all operators are properly trained, know how to safely operate the unit, and are properly supervised.
- Do not operate the product until you are certain all parts are in place and operating correctly.
- Carefully inspect the product on a regular basis and perform all maintenance as specified.
- Service and maintain the unit only with approved replacement parts.
- Keep all instructions permanently with the product and make sure all labels are clean and visible.

Stratus Auto Equipment makes no promises, guarantees or assurances that our products meet any state, county, federal or international mandated permit, license, code, standard, certification, or any other mandate other than what is listed or shown on Stratus Auto Equipment's website. Not all of Stratus Auto Equipment lift models meet the standards as prescribed by ANSI/ALI ALCTV-(current edition) or ANSI/UL 201. Consult [www.autolift.org](http://www.autolift.org) for a complete list of lift models that meet ANSI/ALI ALCTV-(current edition) or ANSI/UL 201 or contact support@stratusautoequip.com

Buyer assumes full responsibility for any state, county, federal or international mandated permit, license, code, standard, certification, or any other mandate required related to the installation and/or operation of any Stratus Equipment. Stratus will not be responsible for any charges, fines, liens, or other levies imposed on the Buyer related to any special or regional structural, seismic or any other building code and/or codes such as the Uniform Building Code (UBC), International Building Code (IBC), or any other state, county, federal or international mandated permit, license, code, standard, certification, or other mandate, law, rule, regulation or directive by any other agency, government, administrations, or corporations whether state, county, federal, or international mandated.

## Unit Information

Be sure to document the Model Number, Serial Number, and Date of Manufacture from the label on your unit below. This information is required for part or warranty issues.



**STRATUS**<sup>®</sup>  
auto equipment

STRATUS AUTO EQUIPMENT  
www.stratusautoequip.com  
sales@stratusautoequip.com  
Tel: 512-640-9896



MODEL:

DATE:

SERIAL NO.

Lifting Capacity:

 lbs

Rated Voltage:

 V

Lifting Height:

 in

Rated Frequency:

 Hz

Min Height:

 in

Phase:

 Ph

Platform Length:

 in

Net Weight:

 lbs

# Index

<b>1. Important Safety Instructions .....</b>	<b>7~11</b>
1.1 Important Notices	
1.2 Qualified Personnel	
1.3 Warning Signs	
1.4 Safety Instructions	
1.5 Labels	
1.6 Sound Level	
1.7 Training	
1.8 Special Reminder	
<b>2. Overview of the Lift.....</b>	<b>12</b>
2.1 General Description	
2.2 Measurements	
<b>3. Installation Instructions.....</b>	<b>13~15</b>
3.1 Precautions for Installation	
3.3 Installation	
<b>4. Operation Instructions.....</b>	<b>16~17</b>
4.1 Precautions	
4.2 Operating Instructions	
<b>5. Frequently Asked Questions.....</b>	<b>18</b>
<b>6. Maintenance.....</b>	<b>19</b>
<b>7. Warranty, Shipping, and Returns.....</b>	<b>20</b>
<b>8. Parameters and Features.....</b>	<b>21</b>
<b>9. Exploded View.....</b>	<b>22~24</b>
<b>10. Automotive Lift Institute Store.....</b>	<b>25</b>
<b>11. Special Notes.....</b>	<b>26</b>

# Important Safety Instructions

## 1.1 Important Notices

- Make sure to pay careful attention to the label of the lifting capacity attached on the lift and never try to lift cars above the lifting capacity labeled.
- Read this manual carefully before operating the machine so as to avoid personnel injury
- Users are not permitted to make any modification to the control or mechanical unit

## 1.2 Qualified Personnel

- Only properly trained individuals are permitted to operate the lift.
- Individuals not

## 1.3 Warning Signs

- All safety warning labels are clearly depicted on the lift to ensure that the operator is aware of and avoids the dangers of using the lift in an incorrect manner. The labels must be kept clean and they have been replaced if detached or damaged. Please read the meaning of each label carefully and understand them for future operation



## 1.4 Safety Instructions

- Make sure that you have read the User's Manual completely, including relevant instructions on installation, operation, and safety before operating the lift.
- This lift is designed for lifting vehicles 9,000 LBS and under. Any other use may result in damage of the lift or injury to personnel.
- Only those who have been properly trained should operate the lift. Customers or inexperienced persons should be prohibited from operating the lift at will.
- Do not load the lift beyond its rated capacity. To reduce the risk of injury, refer to loading instructions, and never attempt to lift more than the rated capacity.
- The lift is designed to lift the entire body of vehicles with weight within the lifting capacity.
- If the lift is designed for indoor use only, outdoor use is prohibited.
- Do not install the lift on any surface other than concrete that is at least 6" thick and has set for at least 30 days.
- Do not move away from controls while lift is in motion.
- Keep hands and feet away from any moving parts, do not put hands in any dangerous places, such as the space between tool arms.
- Do not wear any loose clothing that could be caught in moving parts. Keep hair, fingers, and all body parts away from moving parts. Always wear appropriate safety equipment during operation.
- Keep area around the lift clean to avoid incidents. Any oil stain or obstacle may pose a safety risk.
- Always ensure the safety latches are operational before any attempt to work near or under the vehicle.
- Always ensure the safety locks are engaged before any attempt to work near or under the vehicle.
- Never remove safety related components from the lift.
- Do not use if safety related components are damaged or missing
- Ensure all regular maintenance is completed. If anything abnormal occurs, stop using the lift and immediately contact us for help.
- Do not rock the vehicle while on the lift or remove heavy components that may cause weight shift, as the vehicle could fall.
- Do not modify any part of the lift without manufacturer's advice; THIS VOIDS THE WARRANTY and increases the chances of injury or property damage.
- If the lift is not in use, lower to the lowest position and disconnect power.
- It is prohibited to lift the vehicle while occupied.
- When a vehicle is being loaded or unloaded from the lift, no person is allowed to stand in the vehicle passage.
- Do not use the lift while tired, or under the influence of drugs, alcohol, or medications



- Keep areas well lit.
- Keep loads balanced on the lift platforms. Clear the area immediately if a vehicle is in danger of falling off the lift. **DO NOT ATTEMPT TO CATCH A FALLING VEHICLE!**
- Make sure there are no obstacles under the vehicle before lowering it
- If the lift will be left unused for a long period of time, it is recommended that the user disconnects power, empties the oil tank, and lubricates any moving parts with hydraulic oil



**Attention: For environment protection, please dispose of the used oil in a proper way.**

## WARNING:



1. The warning, cautions and instructions discussed in this manual cannot cover all possible conditions and situations that may occur. It must be understood by the operator that common sense and caution are factors which cannot be built into this product, but must be supplied by operator.
2. ALWAYS ensure the mechanical safety locks are engaged. Never remove safety related components from the lift. Do not use if safety related components are damaged or missing.
3. Failure to correctly install, operate, or any improper modifications could result in injury or death of operators.

### 1.5 Labels

**A**

		STRATUS AUTO EQUIPMENT www.stratusautoequip.com sales@stratusautoequip.com Tel: 512-640-9896			
		MODEL: <input type="text"/>	DATE: <input type="text"/>		
SERIAL NO. <input type="text"/>					
Lifting Capacity:	<input type="text"/>	lbs	Rated Voltage:	<input type="text"/>	V
Lifting Height:	<input type="text"/>	in	Rated Frequency:	<input type="text"/>	Hz
Min Height:	<input type="text"/>	in	Phase:	<input type="text"/>	Ph
Platform Length:	<input type="text"/>	in	Net Weight:	<input type="text"/>	lbs

**B**

 <b>CAUTION</b> 	
<ul style="list-style-type: none"><li>• Only trained personnel is allowed to use the lift.</li><li>• Read the entire manual before operating</li><li>• Never try to raise the vehicle exceeding lift capacity</li><li>• Make sure you meet all safety requirements before you start working under the vehicle</li><li>• Surrounding of lift will remain clear when raising or lowering</li><li>• The manufacturer and distributor will not take any responsibility if user does not follow the operation manual that comes with the lift</li></ul>	

**C**

	 <b>CAUTION</b>
Keep feet clear of the lift when lowering	

**D**

	 <b>CAUTION</b>
Make sure the mechanical safety has been locked before working under the car	

**E**



### 1.6 Sound Level

- The sound emitted from the lift should not exceed 75 DB.

## 1.7 Special Reminder

- The newly installed lift can NOT directly lift vehicle, and should be raised to the highest point then lowered to the lowest point 2-3 times repeatedly without any load to bleed the air out from the hydraulic hose and cylinders to ensure the lift runs smoothly
- 1st time use of the lift with a load after bleeding air out of the the hydraulic hose and cylinders should follow the steps below
  - Loosen the screw cap of the hydraulic oil flow valve and tighten the middle hexagonal screw clockwise inward to the tightest position.
  - Press the “UP” button to raise the lift with loaded vehicle to your desired height.
  - Press and hold the “DOWN” button to wait for the safety lock to be disengaged, then adjust the hydraulic oil flow valve (the middle hexagonal screw) by turning the screw counterclockwise to make the lowering speed reach .5 in/sec or slower.

# Overview of the Lift

## 2.1 Technical data

Model	Lifting Capacity	Lifting Time	Lifting Height	Power Supply
SAE-UT9000	9,000 LBS	~60 Sec	77 9/16"	220V 1ph

## 2.2 Measurements

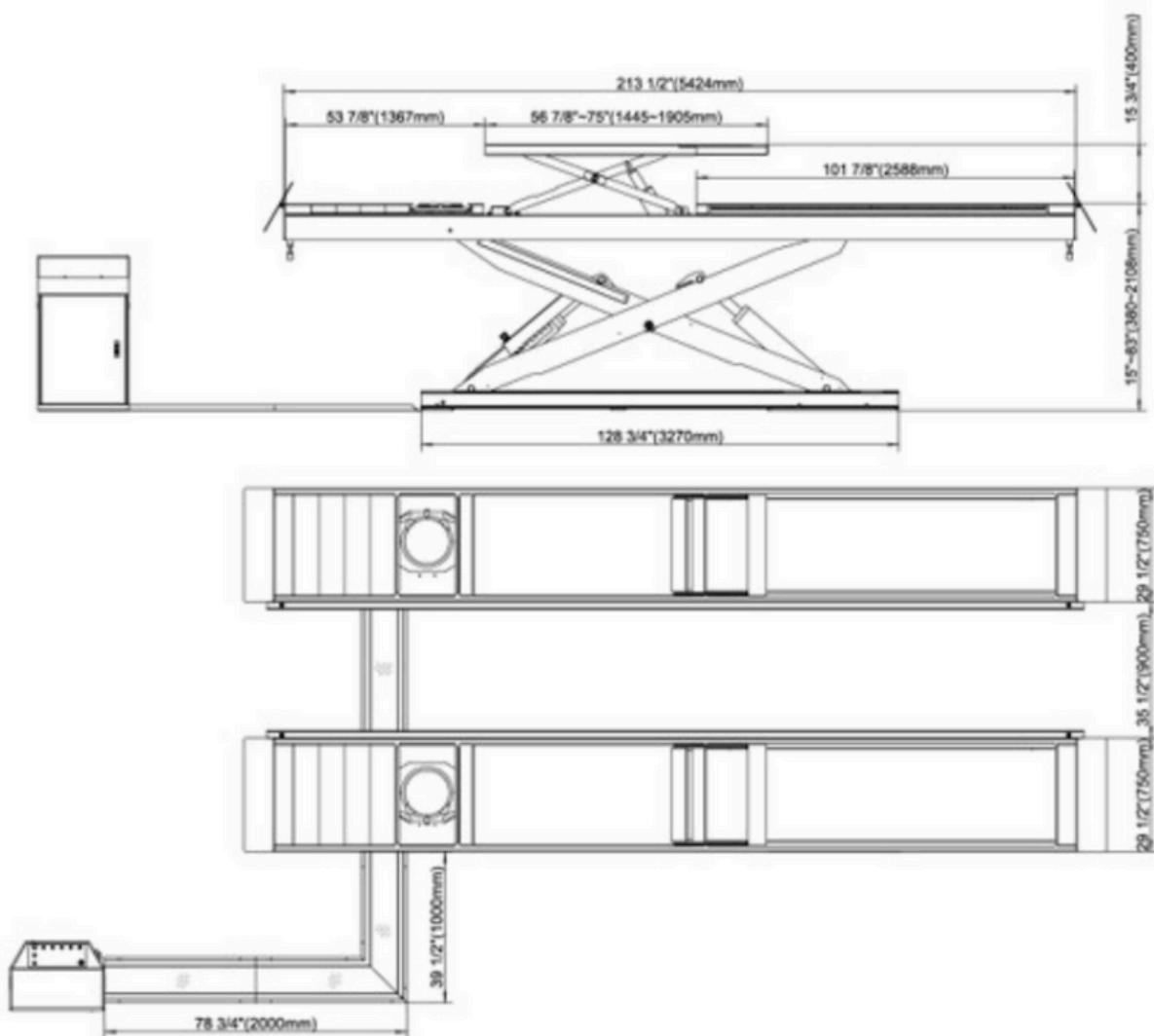

# Installation Instructions

## 3.1 Precautions for Installation

- The joints of the oil hose must be firmly connected in order to avoid leakage
- All bolts should be firmly screwed up
- Do not place any vehicle on the lift during trial running

## 3.2 Installation

- Remove the accessory packages, and take the parts out of their packaging.
- Be sure to check for any missing or damaged parts. **Please call us immediately if there are any missing or damaged parts.**
  - If you do not contact us and insist on installing with missing or damaged parts, we, nor our dealers will bear any responsibility and will charge for any parts subsequently damaged.
  
- Firstly, assemble the mobile kit.
  - Using an allen key to connect the handle of the mobile kit body using the bolt provided
  - Next, using the rod provided, attach the wheels to the mobile kit body
- Once the mobile kit body is assembled, use it to provide leverage to the lift base in order to relocate the lift to the ideal location

- Once your lift is in prime location, connect the hydraulic hose from the lift base to the pump
  
- With the hydraulic hose connected to the pump, fill the tank with hydraulic fluid.
  
- After filling the tank with hydraulic fluid, connect the cables, and proceed to wiring the power plug
  - When wiring the power plug:
    - Yellow Green Wire: ground Wire
    - Blue and Brown Wire:
      - If a 220V power supply is used, both the blue and brown wires will be hot

- **Note:** The foam across the motor is only for shipping safety purposes. Remove the foam before continuing on.
  
- After all wiring and hose connections have been completed, connect the rollers onto the ends of the platforms by removing the rods, placing the roller in place, and sliding the rods back through the slots.
  - This step is easiest with the lift raised
  - **Note:** These roller pieces, can be placed parallel to the platform, or can be moved, so they are at an angle

### **Installing the extension ramps (Optional)**

- With the lift raised, use the screws provided to connect the trapezoidal shaped extending pieces with the narrow end to the base to aid in the connection of the extension ramps.
- After connecting the extending pieces, use the screws provided to attach the extension ramps to each trapezoidal piece.

# Operation Instructions

## 4.1 Precautions

- Check all the joints of the oil hose to ensure there is no leakage
- If the safety device of the lift malfunctions, the lift shall not be used.
- The Machine shall not lift or lower an automobile if its center of gravity is not positioned midway between the rising platforms.
  - If the lift is used while the vehicle's center of gravity is not positioned midway between the rising platforms, Stratus, as well as our dealers will not bear any responsibility for any consequence resulted thereby.
- All individuals should stand in a safe area away from the lift during the lifting and lowering process.
- Make sure the safety lock is engaged before you begin working under the vehicle.
- No people are permitted to be under the vehicle during the lifting and lowering process.

## 4.2 Operating Instructions

### Raising the lift

- Make sure that you have read and understood the operation manual before operation.
- Drive and park the vehicle midway between the two platforms.
- Place the four rubber pads under the lifting-points of the vehicle and ensure the car's gravity has fallen on the rubber pads.
- Press the UP button on the control box until the rubber pads have touched the lifting-points
- Once the vehicle has been raised to the preferred height, press the "Emergency Stop" button before performing maintenance or repair work.

### Lowering the lift

- Switch on (press the "emergency stop button" until the power indicator is on).
- Press the DOWN button to lower the lift.
- Once down, drive the vehicle away from the lift



### 4.3 Emergency lowering

**The safety lock is not engaged:**

- Tie up the safety teeth on both sides with rope; pull upward on the rope to make sure the safety teeth are unlocked.
- Once the safety teeth are unlocked, manually loosen the core of the electro-magnetic valve on the pump assembly.

**The safety lock is engaged:**

- Remove the screw off of the fitting (opposite to the oil outlet) in order to connect a hand pump (OPTIONAL)
- Connect the hydraulic assembly with the optional hand pump.
- Press down on the handle of the pump to raise the platforms to have the safety teeth unlocked.
- Tie up the safety teeth with rope and pull the safety teeth up
- Using a wrench, loosen the core of the electro-magnetic valve to lower the platforms.

## Frequently Asked Questions

- What kind of oil do I use?
  - AW32 or AW46 hydraulic oil
- Does this lift come with a plug?
  - The lift does not come with a plug, you will need to get a 110V, or 220V connection with plug
- How do I hook up the electrical?
  - Yellow Green Wire: ground Wire
  - Blue and Brown Wire:
    - If using a 110V power supply either the blue or brown wire can be wired to be hot. If the blue wire is selected to be hot, the brown wire will be neutral and conversely if the brown wire is selected to be hot, the blue wire will be neutral
    - If a 220V power supply is used, both the blue and brown wires will be hot
- Why is the speed of the lift descent so slow?
  - Downstream throttle valve is tightened too much
    - Loosen the nut of the downstream throttle valve core, rotate the core counterclockwise, and adjust its position according to the descent speed of the lift.
  - Dirty hydraulic oil
    - replace the hydraulic oil
  - Blocked oil pipe
    - Replace the oil pipe
- Why is the speed of the lift ascent so slow?
  - Clogged suction hose filter
    - clean the suction hose filter
- Lift doesn't rise when the up button is pressed and the motor runs
  - Insufficient hydraulic oil
    - add hydraulic oil to reach the standard level for the lift model

# Maintenance

- Daily Pre-operation
  - Check oil hoses for leaks
  - Check the electrical system
  - Check that the plug bolts are firmly screwed
  - Check that the safety teeth and safety block match
- Weekly
  - Check the flexibility of moving parts
  - Check the working conditions of safety parts
  - Check the amount of oil in the oil tank
- Every 1 Month
  - Check the tightness of the hydraulic system and screw firm the joints if leaking
- Ever 12 Months
  - Empty the oil tank and check the quality of the hydraulic oil
  - Wash and clean the oil filter

## Warranty

- 5 years lifting structure Post, Cross Bar, Carriage, Arms, Safety Locks, Safety Lock Pins, Arm Pin, Runway
  - 3 years hydraulic Power Unit/Station, Cylinder
  - 2 years electrical Electrical, Buttons, Solenoid, Limit Switch
  - 1 Year Balance Cable, Safety Lock Release Cable, Safety Covers, Support Bar, Ramps, Hydraulic Hose, Fittings
  - No Warranty Door Guard, Rubber Pads, Truck Adaptors
- \*\*Parts only!! Labor costs for someone to install replacement parts are **NOT** covered.  
The hydraulic cylinders come with a 30 day full warranty and after 30 days we will provide a seal kit\*\*

## Shipping

### CHECK SHIPMENT UPON ARRIVAL

Whereas, we do take precautions to make sure your product gets to you in one piece. There are rare instances where a product may get damaged in transit. You should thoroughly inspect the shipment to make sure all pieces and parts have arrived and document on the bill of lading before accepting. If you are missing any part or damage has occurred, contact us so we can help correct the issue. Please document pictures for records.

## Returns/Cancellations/Refunds

- Returns are only accepted within 14 days from the delivery date, buyer pays return shipping which is non-refundable unless the item sent is incorrect or faulty.
- Merchandise must be unused and packed with the original packages.
- Proof of payment must accompany the return.
- All returned merchandise are subject to inspection. If you are entitled to a refund then we will refund the price of your item.
- We **CHARGE 30% HANDLING & RESTOCKING FEE** if you want to return or cancel the order after we ship out the item. If you choose to cancel your order before we ship it out, your money will be refunded minus a \$250 processing fee.
- Refunds are usually processed within 7 working days of receipt. However, during busy periods this may take longer. We will contact you via email as soon as we have processed your return. Please make sure that your inbox can receive emails from sales@stratusautoequip.com, as this is the email address that we will use to contact you.
- We only offer refunds onto the original payment method used to make the order.

## Parameters

Model	UT9000
Rated Lifting Capacity	9,000 LBS
Minimum Height	4 5/16"
Lifting Height	77 9/16"
Platform Width	25 9/16"
Motor Parameters	220V
Hydraulic Oil	AW32 or AW46

## Features

- Commercial grade open center design
- Low profile, minimum height is 4 5/16"
- On-Ground surface mount or In-ground flush mount (see detailed foundation plan)
- Pneumatic safety lock release
- Durable cylinders with anti-surge valves
- Aluminum motor power unit
- 14 lock position
- 24V low voltage control system
- Platforms can be extended for long vehicles
- Self-lubricated bushing and bearing

# Exploded View

## Pump:

NO.	Description	QTY	NO.	Description	QTY
1	Motor	1	9	Oil Hose Tie-In	1
2	Hydraulic Block	1	10	Electrical Unloading Valve	1
3	Overflow Valve	1	11	Single Way Valve	1
4	Fitting	2	12	Gear Pump	1
5	Cushion Valve	1	13	Oil Tank	1
6	Absorbing Oil Pipe	1	14	Oil Tank Cover	1
7	Oil Filer	1	15	Oil Back Pipe	1
8	Throttle Valve	1			

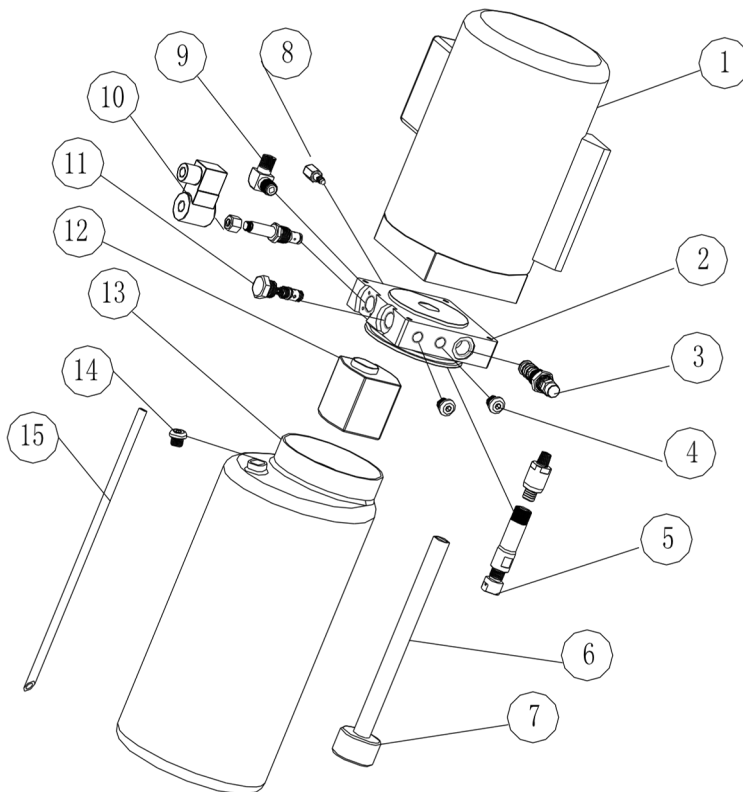

# Automotive Lift Institute Store

You probably checked the [ALI's Directory of Certified Lifts](http://www.autolift.org/ali-directory-of-certified-lifts/) (www.autolift.org/ali-directory-of-certified-lifts/) before making your most recent Lift purchase, but did you know the [ALI Store](http://www.autolift.org/ali-store/) (www.autolift.org/ali-store/) offers a wide variety of professional, easy-to-use, and reasonably priced training and safety materials that will make your garage a safer place to work?

The ALI Store is your trusted source for workplace safety!



**Lifting It Right Online Certificate Course.** Make *sure* you and your people are lifting vehicles the right way.



**ALI Lift Inspector Certification Program Registration.** Become a **ALI Certified Lift Inspector.**

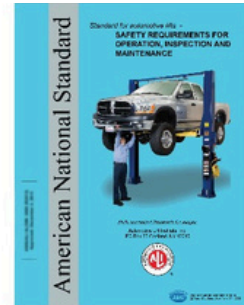

**ANSI/ALI ALOIM Standard for Automotive Lifts.** Safety Requirements for Operation, Inspection, and Maintenance.

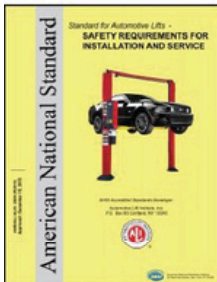

**ANSI/ALI ALIS Standard.** Safety Requirements for Installation and Service.

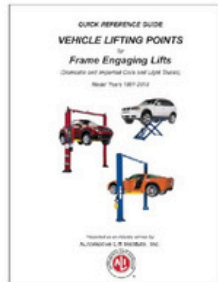

**Guide to Identifying Vehicle Lifting Points for Frame-Engaging Lifts.** Don't eyeball your lifting points, *know* where they are.



**Lift Operator Safety Materials.** Five safety documents in a single package.

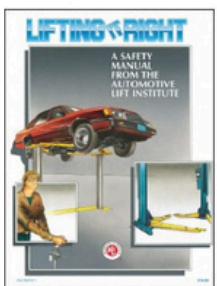

**Lifting It Right.** A hardcopy version of the *Lifting It Right* safety manual from the Automotive Lift Institute.



**Uniform Warning Labels and Placards for 2-Posts.** Labels in Mandarin, French Canadian, and Spanish are also available.



**Safety Tips Card.** Reminds your people of 13 key safety tips to follow daily.

Visit today and get the training and materials you need to worksafely:

[www.autolift.org/ali-store/](http://www.autolift.org/ali-store/)

## Special Notes

### **Environmental damage :**

- Only appropriately trained personnel may dismantle and dispose of the unit.

### **Dismantling:**

- To dismantle the product, proceed as follows:

#### **ELECTRICAL HAZARD!**

- When carrying out any decommissioning and dismantling work on the unit, switch off all power supply connections, ensure they cannot be switched on unintentionally and verify that they have been disconnected. Earth and short-circuit them, and cover or otherwise isolate any neighboring live parts. Failure to do so may lead to serious injuries or death.

#### **HIGH PRESSURE HAZARD.**

- When carrying out any unit decommissioning and dismantling work, close off and empty all the connection pipes until the pressure is the same as the ambient air pressure. Failure to do so may lead to injury.
- Make sure that the hydraulic circuit has been switched off. Close all hydraulic shut-off valves.
- Disconnect all connections, making sure at the same time, that no operating materials escape, such as oil, refrigerant and water- glycol mixture.
- Loosen the connection to the base.

#### **PERSONAL INJURY!**

- Secure the unit against slipping. The unit is ready for transporting.
- It is important that all transport information is observe

### **Disposal:**

- A specialist company with the appropriate competence must dispose of the unit and individual components. This technical services department must ensure that:
  - the components are separated according to material types
  - that the operating materials are sorted and separated according to their properties.

#### **ENVIRONMENTAL DAMAGE.**

- Dispose of all components and operating materials (such as oil, refrigerant and water-glycol mixture) separately according to material and in line with local laws and environmental regulations.

### **Noise Declaration:**

- Sound power level: LWA<85dB Accompanied uncertainly K=4 dB
- With the rated load, the pump motor rotate.
- Applied operating conditions are:
- According to the test report, the operating position is the loudest, but the noise risk is not a hazard, as the volume should not be high enough to hurt the operator.
- If the volume is higher than 85 dB, the lift must be stopped and check for troubles and repairs.