



HYDRAULIC BENDING ROLLS

Model: HBR-0425 HBR-05316

HBR-0525 HBR-0625

HBR-0808

Operation & Parts Manual



Table of contents

I	MAIN SPECIFICATION AND WARNING	Page 3-5
II	SAFETY INSTRUCTIONS	Page 6-8
III	OPERATION INSTRUCTIONS	Page 9-11
IV	ELECTRICAL SYSTEM	Page 12-17
V	LUBRICATION AND TROUBLE SHOOTING	Page 17-18
VI	HYDRAULIC DRAWING AND ELECTRICAL DRAWING	Page 19-20
VII	PARTS BREAKDOWN	Page 21-24

I MAIN SPECIFICATIONS

Model	HBR-0425	HBR-05316	HBR-0525	HBR-0625	HBR-0808
Mild steel capacity	4'X1/4" mild steel	5'x3/16" mild steel	5'x1/4" mild steel	6'x1/4" mild steel	8'x8Ga. Mild steel
Roll diameter	5-7/8"	5-7/8"	7"	7-1/2"	6-1/2"
	150mm	150mm	180mm	190mm	165mm
Hydraulic bending roll	standard	standard	standard	standard	standard
	standard	standard	standard	standard	standard
motor	3 HP,220V,3ph	5.5HP,220V,3ph	5.5HP,220V,3ph	7.5HP,220V,3ph	7.5HP,220V,3ph
	2.2 KW	4.0 KW	4.0 KW	5.5 KW	5.5 KW
Dimension	91"x40"x56"	102"x41"x56"	102"x41"x56"	125"x43"x57"	141"x40"x57"
	230x102x142cm	260x105x143cm	260x105x143cm	318x108x145cm	357x102x145cm
Package	METAL PALLET	METAL PALLET	METAL PALLET	METAL PALLET	METAL PALLET
Weight	4850 LBS	6650 LBS	6850 LBS	8350 LBS	8950 LBS

WARNING!

This manual provides critical safety instructions on the proper setup, operation, maintenance, and service of this machine/tool. Save this document, refer to it often, and use it to instruct other operators.

Failure to read, understand and follow the instructions in this manual may result in fire or serious personal injury—including amputation, electrocution, or death.

The owner of this machine/tool is solely responsible for its safe use. This responsibility includes but is not limited to proper installation in a safe environment, personnel training and usage authorization, proper inspection and maintenance, manual availability and comprehension, application of safety devices, cutting/sanding/grinding tool integrity, and the usage of personal protective equipment.

The manufacturer will not be held liable for injury or property damage from negligence, improper training, machine modifications or misuse.

WARNING!

Some dust created by power sanding, sawing, grinding, drilling, and other construction activities contains chemicals known to the State of California to cause cancer, birth defects or other reproductive harm. Some examples of these chemicals are:

- Lead from lead-based paints.
- Crystalline silica from bricks, cement and other masonry products.
- Arsenic and chromium from chemically-treated lumber.

Your risk from these exposures varies, depending on how often you do this type of work. To reduce your exposure to these chemicals: Work in a well ventilated area, and work with approved safety equipment, such as those dust masks that are specially designed to filter out microscopic particles.

WARNING

WEARING PROPER APPAREL. Do not wear clothing, apparel or jewelry that can become entangled in moving parts. Always tie back or cover long hair. Wear non-slip footwear to avoid accidental slips, which could cause loss of workpiece control.

HAZARDOUS DUST. Dust created while using machinery may cause cancer, birth defects, or long-term respiratory damage. Be aware of dust hazards associated with each workpiece material, and always wear a NIOSH-approved respirator to reduce your risk.

HEARING PROTECTION. Always wear hearing protection when operating or observing loud machinery. Extended exposure to this noise without hearing protection can cause permanent hearing loss.

REMOVE ADJUSTING TOOLS. Tools left on machinery can become dangerous projectiles upon startup. Never leave chuck keys, wrenches, or any other tools on machine. Always verify removal before starting!

USE CORRECT TOOL FOR THE JOB. Only use this tool for its intended purpose—do not force it or an attachment to do a job for which it was not designed. Never make unapproved modifications—modifying tool or using it differently than intended may result in malfunction or mechanical failure that can lead to personal injury or death!

AWKWARD POSITIONS. Keep proper footing and balance at all times when operating machine. Do not overreach! Avoid awkward hand positions that make workpiece control difficult or increase the risk of accidental injury.

CHILDREN & BYSTANDERS. Keep children and bystanders at a safe distance from the work area. Stop using machine if they become a distraction.

GUARDS & COVERS. Guards and covers reduce accidental contact with moving parts or flying debris. Make sure they are properly installed, undamaged, and working correctly.

FORCING MACHINERY. Do not force machine. It will do the job safer and better at the rate for which it was designed.

NEVER STAND ON MACHINE. Serious injury may occur if machine is tipped or if the cutting tool is unintentionally contacted.

STABLE MACHINE. Unexpected movement during operation greatly increases risk of injury or loss of control. Before starting, verify machine is stable and mobile base (if used) is locked.

USE RECOMMENDED ACCESSORIES. Consult this owner's manual or the manufacturer for recommended accessories. Using improper accessories will increase the risk of serious injury.

UNATTENDED OPERATION. To reduce the risk of accidental injury, turn machine **OFF** and ensure all moving parts completely stop before walking away. Never leave machine running while unattended.

MAINTAIN WITH CARE. Follow all maintenance instructions and lubrication schedules to keep machine in good working condition. A machine that is improperly maintained could malfunction, leading to serious personal injury or death.

CHECK DAMAGED PARTS. Regularly inspect machine for any condition that may affect safe operation. Immediately repair or replace damaged or mis-adjusted parts before operating machine.

MAINTAIN POWER CORDS. When disconnecting cord-connected machines from power, grab and pull the plug—NOT the cord. Pulling the cord may damage the wires inside. Do not handle cord/plug with wet hands. Avoid cord damage by keeping it away from heated surfaces, high traffic areas, harsh chemicals, and wet/damp locations.

EXPERIENCING DIFFICULTIES. If at any time you experience difficulties performing the intended operation, stop using the machine! Contact our Technical Support

II SAFETY INSTRUCTION

Save this manual: You will need the manual for the safety warnings and precautions, assembly instructions, operating and maintenance procedures, parts list and diagram. Keep your invoice with this manual. Keep the manual and invoice in a safe and dry place for future reference.

WARNING: THIS IS VERY DANGEROUS FAILURE TO FOLLOW THESE RULES MAY RESULT IN SERIOUS PERSONAL INJURY As with all machinery there are certain hazards involved with operation and use of the machine. Using the machine with respect and caution will considerably lessen the possibility of personal injury. However, if normal safety precautions are overlooked or ignored, personal injury to the operator may result.

This machine was designed and constructed for roll forming metal plates 65,000 PSI or Less

. This machine SHOULD NOT be modified and/or used for any application other than for which it was designed. If you have any questions about its application, do not use the machine until you contact with us and we have advised you. Modification will void all warranties

Read all instructions before using this tool!

1. MACHINERY GENERAL SAFETY WARNINGS

- 1) Misuse of this machine can cause serious injury. For safety, machine must be set up, used and serviced properly. Please Read, understand and follow instructions in the operator's and parts manual which were shipped with your machine.
- 2) Wear proper clothes: . No loose clothing or jewelry which can get caught in moving parts. Rubber soled steel tipped shoes or boots are recommended for best footing. Wear Safety Glasses at all times. Protect your hands from sharp edges of your material
Rolling in the machine
- 3) Do not overreach. Failure to maintain proper working position can cause you to fall into the machine or cause your clothing to get caught — pulling you into the machine.
- 4) Keep guards and safety wire stops in place and in proper working order. Do not operate the machine with guards or safety line removed.
- 5) Avoid dangerous working environments. Do not use in wet or damp locations. Keep work areas clean and well lighted
- 6) Avoid accidental starts. Make sure switch is in “OFF” position before plugging

- in power cord
- 7) Never leave the machine running while unattended. Machine shall be shut off and power is disconnected whenever it is not in operation. Make sure **ALL ESTOPS** Are pushed in when not in use.
 - 8) Disconnect electrical power before servicing. Whenever changing accessories or performing general maintenance on the machine, the electrical power to the machine must be disconnected before work is started
 - 9) Machinery must be anchored to the floor.
 - 10) Use the right tool. Know the tool you are using — its application, limitations, and potential hazards. Don't force a tool or attachment to do a job it was not designed for.
 - 11) Stay alert Watch what you are doing; use common sense. Do not operate any tool when you are tired. Keep hands in sight and clear of all moving parts and rolling surfaces at all time
 - 12) Keep children away. Children must never be allowed in the work area. Do not let them handle the machines, tools, or extension cords.
 - 13) All visitors should be kept at a safe distance from the work area **ONLY TRAINED OPERATORS** should use this machine
 - 14) . Make sure workshop are completely safe by using padlocks, master switches, or by removing starter keys.
 - 15) Store idle equipment when not in use, tools must be stored in a dry location to inhibit rust. Always lock up tools and keep out of reach of children.
 - 16) General Electrical Cautions: This machine should be grounded in accordance with the National Electrical Code and local codes and ordinances. This work should be done by a qualified licensed industrial electrician. The machine should be grounded to protect the user from electrical shock.

2. TRANSPORTATION (CRANE OR FORKLIFT IS RECOMMEND)

- Transportation before un-packing
 1. The fork truck or crane should be capable of lifting weight over 2000 kgs.
 2. The steel wire of the crane must be arranged properly as per cavity center of wooden box.
 3. The crane (or forklift) operator should be a licensed, qualified & trained person.
 4. Machine should be loaded at the cavity center of truck to avoid any sliding.
 5. After loading onto truck, the machine should be properly strapped a]or chained to ensure firmly secured prior to the truck departing

3. POSITIONING & CLEANING

- Site : When you select site, ensure there is enough free space for material

handing around the machine.

- Foundation: The machine requires a plane & stable ground surface to achieve excellent bending performance. It is better to have a 150mm (6") reinforced concrete floor
- Leveling: Four Jack Screws (M20 x 60) are included. Place machine feet on Steel Plates of at least .375" to .500" thickness. Use leveling screws to level machine and shim stock to complete leveling. Once Level back off Jack Screws until just snug with steel plate. Machine should not be held up by Screw threads this will cause cross threading while in use.
- Cleaning: Use a liquid solvent such as mineral spirits to remove the protective coating and any dirt from the up-painted surface of the machine. Don't disturb any moving parts until all surfaces have been cleaned. When not in use, use a light rust prohibiter on the rolls to protect from pitting

4. ELECTRIC CONNECTION

ALL CONNECTIONS MUST BE MADE BY LICENSED INDUSTRIAL ELECTRICIAN

ALL CONNECTIONS MADE BY NON LICENSED ELECTRICIAN WILL VOID THE WARRANTY AGAINST ELTRICAL FAULTS

- Before connecting machine into local 3-phase ac source at your plant, please double check same voltage and phase.

- Connect the ac source with **PROPER** machine **WIRE AND GAUGE THICKNESS.**

CONSULT YOUR LICENSED ELTRICIAN AND LOCAL CITY CODES FOR PROPWER WIRE SIZE AND AMP RATINGS.

3 Phase WIRE MUST HAVE 4 wires, the ground wire must to be connected with ground.

- After connecting ac source **QUICKLY START AND STOP MOTOR TO CHECK** the shaft motor rotation is in the correct rotation direction as per the arrow on the motor.

- If wrong direction, please immediately stop motor to avoid motor damage. Please correct your connecting wires at ac source until motor rotation direction is in correct direction.

III OPERATION INSTRUCTIONS

1. HOW TO ROLL FORMING CIRCLE

- 1) Length of material –to make the correct size cylinder or circle needed,
Use the formula “ $C = \pi \times ID$ ”(C is Circumference; π is 3.1416; ID is Internal Diameter).

Example: ID=200mm, the operator will need to prepare material length
Approximate 630.32mm

- 2) Cut a few pieces of material to the measured length for testing.
The material might need to be lengthened or shortened depending upon the testing results.
- 3) Make a radius template of the desired diameter to use as a guide
- 4) Loosen the clamping screws to the right position which operator can insert the material between upper roll and bottom roller, then fasten the clamping screws to ensure upper roller and bottom roller clamp in the proper pressure.
- 5) Set the idle roller to the same height as bottom roller.
- 6) Power on the foot switch to move the material between upper roller and bottom roller forward to ensure the front-side of the steel plate will pass through the idle roller. **(Drawing No.01)**
- 7) Ensure the rear end-side of the plate steel does not leave the space between the upper roller and bottom roller. **(Drawing No.02)**
- 8) Raise the idle bending **(forming roll)** the end-side of the material to the desired angle to complete the pre-bending at the rear end-side of the measured length. **(Drawing No.03 &04).**
- 9) Remove the material which has completed the pre-bending at rear end-side to the expected diameter.
- 10) Repeat same step of No.3-7 **(Drawing No.5-6)** but pre-bend at the front end-side of the material.
- 11) Move Down the idle roller as soon as the material has been pre-bent at the end side of front and the rear plate to the expected diameter.**(Drawing No.7)**
- 12) Raise the idle roller step by step. The upper roller and bottom roller will form the material to the desired circle **.(Drawing No.8 & 9)**
- 13) If the finished sample is not long enough or if the formed part is not the proper diameter, additional samples will have to be made. Thousands of identical parts can be precisely duplicated when proper adjustments of the roller have been

made.

- 14) Save the correct modifying and forming test piece adjustments for your file your records.
- 15) The same diameter as the diameter of the rolls and slightly larger can be formed.

To make the adjustment for the material thickness and to determine the material length need to refer to step No.1~9.

2. PROCESS DRAWING OF ROLL FORMING

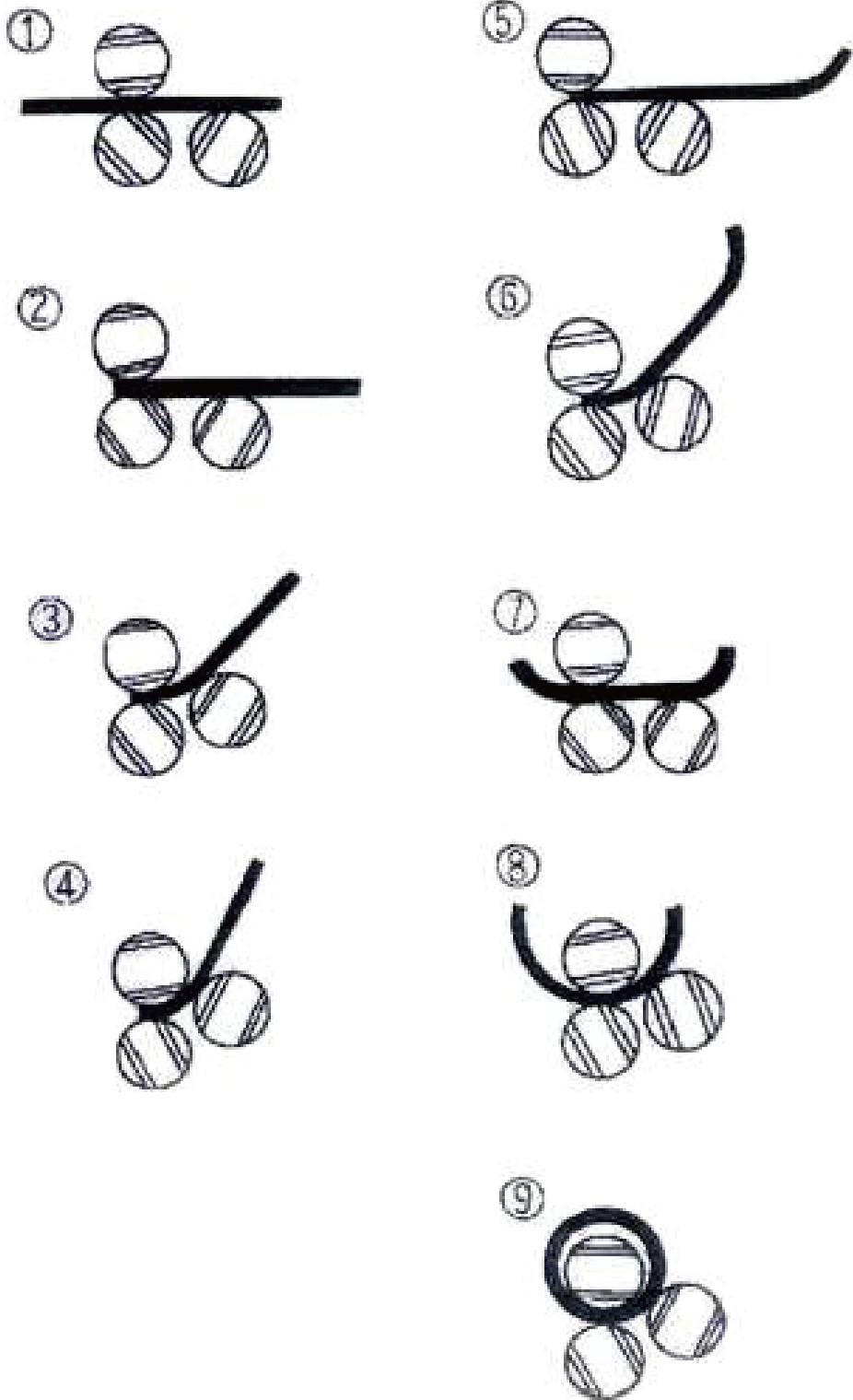

IV ELECTRICAL SYSTEM

1. GENERAL DESCRIPTION

Hydraulic/ Electric Plate Rolls are controlled by the hydraulic system completely.

The foot pedal controls forward and reverse, on and off of the hydraulics, up and down of the rear axle tilt, are controlled by buttons on the faceplate.

2. OPERATION STEPS

1) Rotate the power supply switch on the electrical-box, then power on and the indicator light will be illuminated.



2) Press the START button on foot pedal controller, the motor starts up, hydraulic system is now ready to work. Press the emergency stop button down, the motor stops and hydraulic system also shuts off.



3) After power on, press the START button (on foot pedal) hydraulic pump runs, but if the upper roller isn't in the correct rolling place, all the actions of forward

rotation and reverse, up and down cannot move. When upper roller returns to correct starting point and presses the limited switch down, all the actions can be carried out. The up and down of rear axle is protected by a limit switch. When the rolls reaches the highest point, the rear axle presses the upper limit switch down, the UP button is inoperative right now, but the function of forward rotation and reverse, and the function of the down are still normal. In the same way, when reach the lowest point, the rear axle presses the lower limit switch down, the DOWN button is inoperative right now, but the function of forward rotation and reverse and the function of up are still normal. The buttons UP and DOWN control hydraulic cylinders at both sides (left and right) up and down at the same time. The left buttons UP and DOWN just control left hydraulic cylinders up and down.

Protection function: If the operator touches the safety line while working normally, the indicator light for the RESET button is illuminated, it gives an alarm, and hydraulic pressure stops. At the moment hydraulic pressure is off, and you will need press the reset button down to eliminate alarm, the indicator light goes out, press the START button on foot pedal and the hydraulic system will restart

Before rolling, you need to adjust the rear axle and upper axle to be level.

There 2 types of rolling: straight tube and cone rolling

1. Rolling straight tubes

Turn the handle to make the distance between the upper roller and front roller wide enough (depends on the thickness of the material.) to grab the material



Put the steel plate through upper roller and front lower roller



step on right foot pedal, steel plate moves backwards through the rolls; step on left foot pedal, steel plate moves forward



after one pass ,press the button which controls the rear axle up simultaneously, gradually increase the bending roll upwards on each pass until get the shape wanted.



After you get the desired shape, please remove the part as shown in the next photos



Then pull the upper roller to remove the formed part

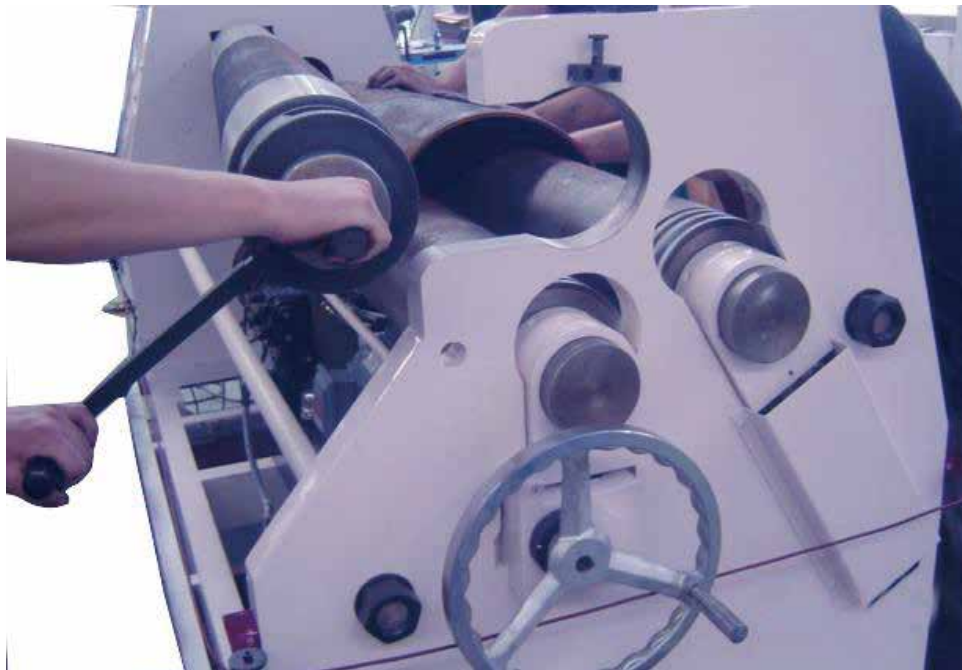

2.Rolling cones

- 1) Prepare the material like a fan, please see the following process

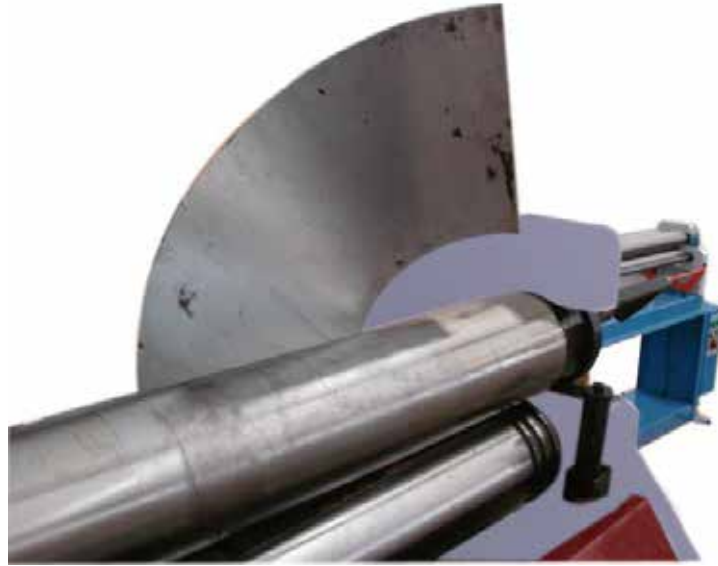

- 2) Press the yellow button and black button to adjust the rear axle and upper roller level until the distance could clamp the material tightly at the shorter side.



After adjusting the rear axle and upper roller level, put the steel plate through upper roller, front lower roller and rear axle, step on right foot pedal, steel plate moves back through roller's drive; step on left foot pedal, steel plate moves forward, after one circulation, press the button which controls right rear axle up, then press the button which controls up simultaneously according to situation, make rear roller up a certain distance, the distance is displayed on the meter, until get the shape wanted.

NOTICE:

1. The right and left hydraulic cylinders work in step, this was adjusted when assemble, don't need adjust before work.

2. Need check the equalization of space before rolling, to insure the parallelism between upper roller and rear roller.

3. The counter was adjusted before delivery, just need check the parallelism between upper roller and rear roller before rolling, don't need set to ZERO every time.

4. While rolling, the rear axle's up and down is inoperative; while the rear axle up and down, the rolling is inoperative.

5. The right hydraulic cylinder's up and down drives the chain's moving up and down, then the chain drives encoder, the signal of encoder is displayed on counter, that's the figure displayed on counter. The encoder shouldn't be hit !!!

V. LUBRICATION

a. In this machine we have six parts have oil cups, please pay attention to the following pictures, you should lubricate three times a day, using lubrication oil Shell Tonna-33 or Mobile VACTRA-2

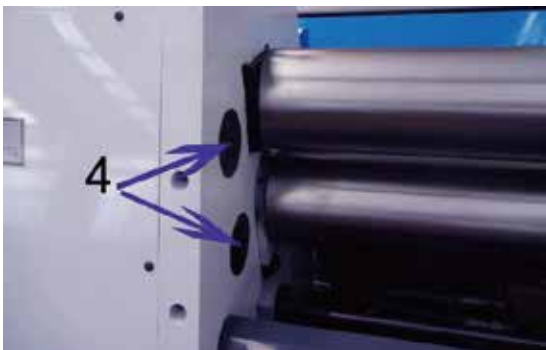
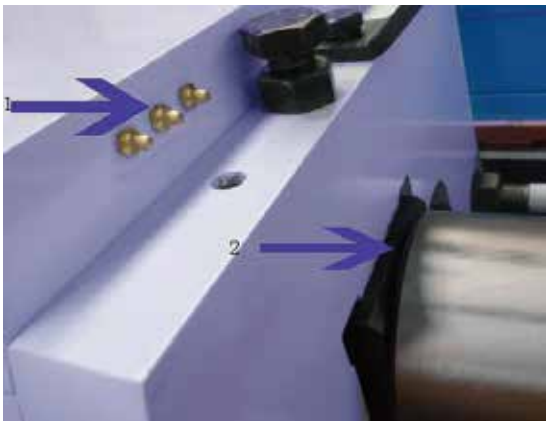

TROUBLESHOOTING FOR GMC HBR-0525 SERIES HYDRAULIC ROLLS

Call GMC Service at 909-947-7787

PROBLEM	SOLUTION
The motor runs and no function	Check and make sure the motor rotation is correct
	Check the power voltage, 220V or 440V, +- 10%
	Voltage can not be lower than 208V
The rolls do not turn	Check and make sure the motor rotation correct
	On the control foot pedal, if the reset push button lights on, push it off
	The safety limit switch for the top roller is off position, need to reset it back, located inside the left gear cover
Top roller can not push back	Need to jog the foot pedal to turn the rolls a little bit because the driven gears are not engaged well
Bending roll does not parallel move up/down	Make sure to shift the selection switch to bending roll parallel movement
	Move the bending roll all the way up and then all the way down a few times to make the roll parallel
Bending roll does not tilt	Check the selection switch for bending roll tilting
	Check the solenoid valve for bending roll titling
Bending roll tilt but does not come back up	Use screwdriver to push and hold the core shaft on Y2 solenoid valve, meanwhile press and hold the green button to let the bending roll come back to parallel, make sure the tilting switch is on the tilt mode
Push or pull the safety cable but do not shut down the machine	Check the limit switch for the safety cable to make sure the distance is correct
The digital display number does not change when the bending roll moves up or down	The chain for the encoder is out of place
	Display wires may be loose or display is bad
	The encoder is bad
How to make cone	Tilt the bending roll and use the cone attachment
How to limit the flat spot	Make sure the pinch roll can not touch the material, need a little gap
	Roll the material one pass, then slip over the material and roll second pass, and repeat to make a round part
How to change hydraulic oil	Drain the old hydraulic oil then clean the filter inside the tank
	Replace the outside fine filter
	Clean the oil tank
Material has cracking waves	Make sure the pinch roll isn't touching the material, needs a little gap

VI. HYDRAULIC DRAWING AND ELECTRIC DRAWING

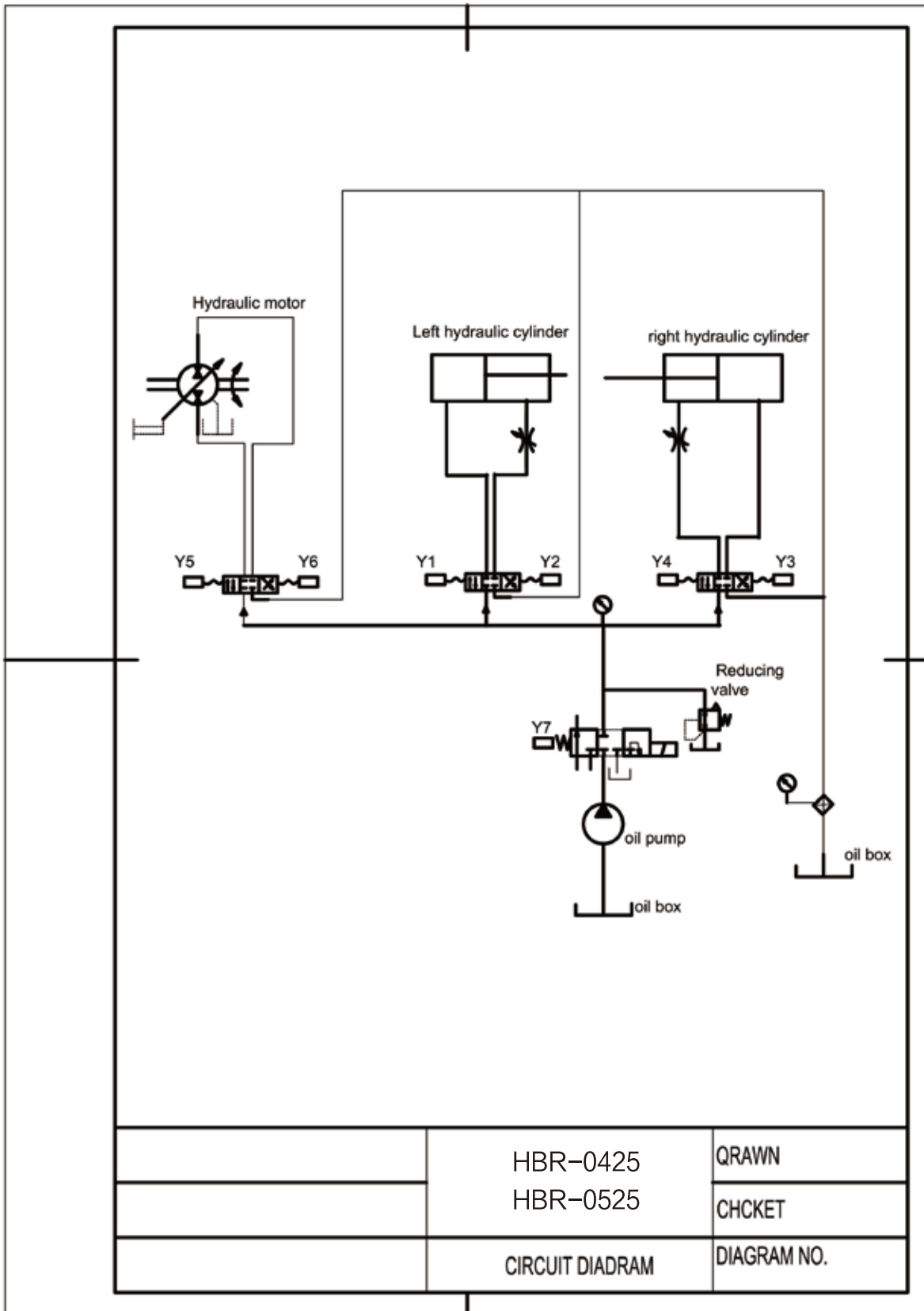

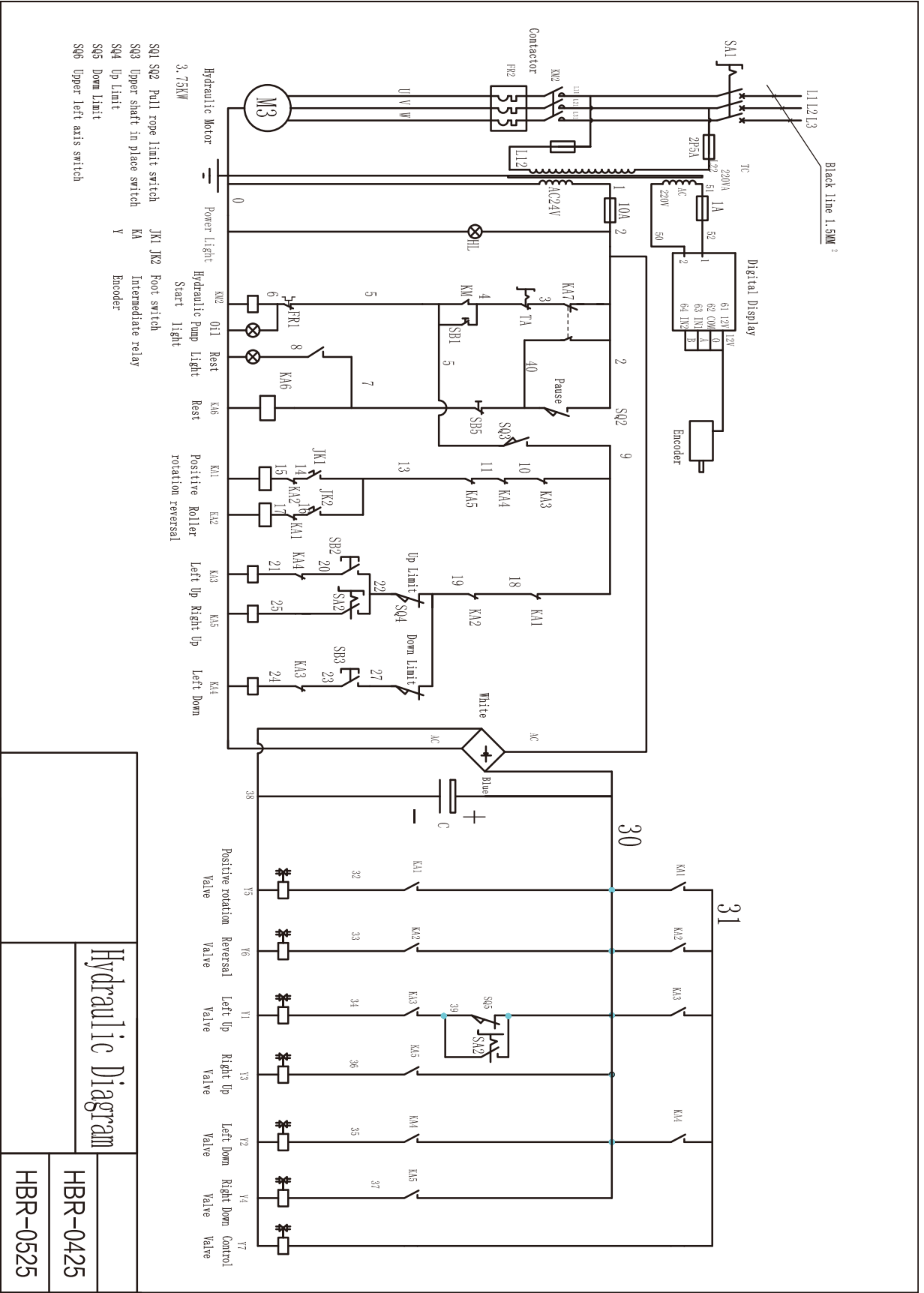

Hydraulic Diagram

HBR-0425

HBR-0525

VII PARTS LIST

Part #	Description	Size	Q'ty	Part #	Description		Q'ty
1	Upper Protecting Cover		1	39	Spacer Bush		2
2	Bolt	M6X16	8	40	Junction Plate	M6X35	1
3	Dishing Spring	A12.5-1	2	41	Screw		4
4	Holding screw	M8X8	7	42	Compression Spring		1
5	Spring Retainer ring	55	1	43	Block		1
6	Permanent seat		1	44	Spring Pin	3X16	1
7	Joint bearing		1	45	Small Shaft		1
8	End cover		1	46	Bush		1
9	Holding cover M8X20	M8X20	2	47	Nut	M12	22
10	End cover		1	48	Screw	M5X25	2
11	Spindle		1	49	Cable Clamp	M3	2
12	Gear (HER-1300X6.5)	5 M, 60 T	1	50	Decelerator		1
	Gear (HER-1550X6.5)	5M, 70T	1				
	Gear (HER-2070X6.5)	5M, 70T	1				
	Gear (HER-2500X4.0)	5 M, 70T	1				
13	Socket Head Screw	M6X10	21	51	Dishing Spring	A25	12
14	Internal-tooth Washer	6	21	52	Pressing Cover		1
15	Tailgate		1	53	Bolt	M12X50	6
16	Spacer Bush		1	54	Key	14X60	1
17	Gear (HER-1300X6.5)	6M,22T	3	55	Spacer Bush		1
	Gear (HER-1550X6.5)	6M,27T	3				
	Gear (HER-2070X6.5)	6M,27T	3				
	Gear (HER-2500X4.0)	6M,22T	3				
18	Mat		1	56	Bush		2
19	Bush		6	57	Small chain wheel	15T	1
20	Adjusting block		1	58	Bolt	M12X80	16
21	Bush		1	59	Spindle		1
22	Key	16X50	4	60	Spindle		1
23	Upper Spindle		1	61	Gear(HER-1300X6.5)	6M,25T	2
					Gear (HER-1550X6.5)	6M,30T	2
					Gear (HER-2070X6.5)	6M,30T	2
					Gear (HER-2500X4.0)	6M,25T	2
24	Spindle		2	62	Bush		2
25	Backshaft		1	63	End Cover		2
26	Holding Screw	M10X20	1	64	Bolt		2

27	Nut	M40X2	8	65	Bush		1
28	Bolt		1	66	Chain		1
29	Bolt	M16X35	2	67	Sprocket		1
30	Nut	M16	5	68	Bush		1
31	Lifting Plate		2	69	Bolt		1
32	Nut	M24	3	70	Adapter Sleeve		2
33	Lower Shaft		1	71	Bearing		4
34	Holding Screw	M8X10	2	72	Endless screw		1
35	Adapter Sleeve		1	73	Key	6X30	2
36	Adjusting Block		2	74	Worm Gear Box		1
37	Holding Screw	M10X25	2	75	Adapter Sleeve		2
38	Holding Screw	M10X35	2	76	Bearing		2
77	Bush		5	117	Spindle		1
78	Bearing		4	118	Bush		1
79	Worm Gear		2	119	End Cover		1
80	End Cover		2	120	Bolt	M10X20	2
81	Screw Rod		2	121	Connecting Shaft		1
82	Screw	M12X25	3	122	Key	6X25	2
83	Mat		1	123	Shaft Coupling		1
84	Mat		2	124	Encoder		1
85	Holding Screw	M10X16	1	125	Fixed Tray		1
86	Junction Plate		1	126	Bolt	M4X8	3
87	Bush		3	127	Small Chain Wheel		1
88	Connecting Plate		1	128	Toggle Screw	M10X17	1
89	Gear(HER-1300X6.5)	6M,20T	1	129	Lock Sleeve		1
	Gear (HER-1550X6.5)	6M,14T	1				
	Gear (HER-2070X6.5)	6M,20T	1				
	Gear (HER-2500X4.0)	6M,20T	1				
90	Small Shaft		1	130	Screw	M8X35	1
91	Hydraulic Cylinder		2	131	Handle Lever		1
92	Holding Screw	M10X50	4	132	Tie Rod		1
93	Adjusting Block		2	133	Handle		1
94	Nut	M5	2	134	Bush		2
95	Bolt	M6X20	7	135	Bearing		2
96	Stand		1	136	Stand		1
97	Eyelet Bolt	M6X60	1	137	Idler wheel		2
98	Cable Wire		1	138	Chain Wheel		1
99	Left Stand		1	139	Screw	M3X16	1

100	Electric Box		1	140	Slide Block		1
101	Shield		1	141	Washer	10	1
102	Tie Rod		1	142	Right Stand		
103	Washer	24	4	143	Handle		1
104	Bolt		1	144	Spring Pin	2X10	1
104	Bolt		1	144	Spring Pin	2X10	1
105	Nut	M20	2	145	Connecting Bolt		1
106	Split Pin	3X50	4	146	Compression Spring		1
107	Small Shaft		1	147	Small Spindle		1
108	Connecting Plate		1	148	Link Block		1
109	Bush		1	149	Screw	M3X20	1
110	Base		1	150	Shield of Hydraulic Cylinder		1
111	Hydraulic Station		1	151	Handle Wheel		1
112	Front Stop Plate		1	152	Handle		1
113	Washer	20	1	153	Fixed Axis of Hydraulic Cylinder		2
114	Link Block		1	154	Endless Screw		1
115	Adapter Sleeve		1	155	Screw	M10X50	6
116	Screw	M16X35	1	156	Worm Gear Box		1

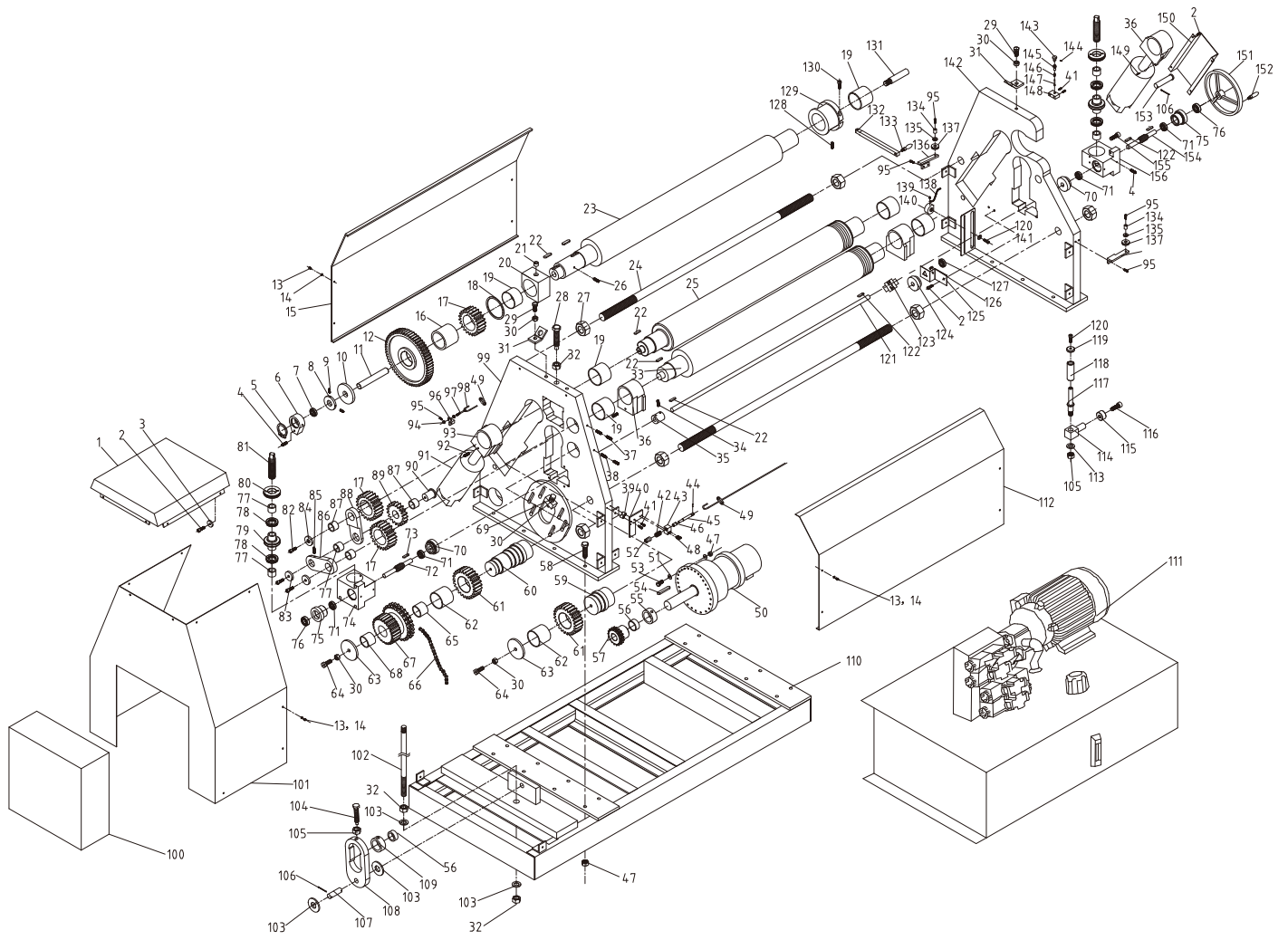

Note: This manual is only for your reference. Owing to the continuous improvement of the machine, changes may be made at any time without obligation on notice. And please note the local voltage while operating this electric machine.