

BendPak®

AP-SRT

Two-Post Mid Rise Lift



10AP-SRT
10,000 lb. Capacity

12AP-SRT
12,000 lb. Capacity



360° AUTOMATIC SWING ARM RESTRAINT SYSTEM

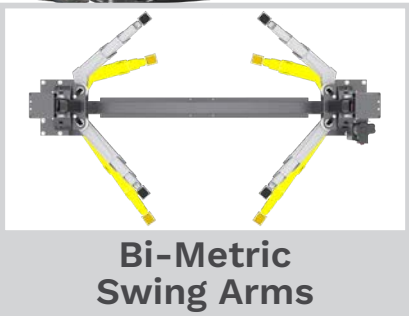

**Bi-Metric
Swing Arms**



Triple-Telescoping



**Innovative
Safety Lock**

PRODUCT DETAIL

The Ultimate Mid-Rise Lift

At BendPak, we understand that different jobs require different tools. You're not always going to need a standard lift so you can stand under a vehicle, and that's where the 12AP-SRT comes in. This short-rise, short-column lift is the latest addition to the revolutionary AP Series and fits perfectly in shops and low-ceiling garages. It's also capable of safely handling up to 12,000 lbs.



FEATURES

1. Dual Hydraulic Direct-Drive Cylinders
2. Electric/Hydraulic HVLP Power System
3. Single-Point Safety Release
4. Drop-End Arms Provide a Lower Pad Height
5. Durable Powder Coat Finish
6. Safety Locks in Each Column Spaced Every 3.75"
7. 40" Tall Carriages for Superior Strength and Durability (10AP-SRT Only)
8. Double-Telescoping Screw Pads Offer Increased Versatility (10AP-SRT Only)
9. Heavy-Duty ½" Aircraft-Quality Equalizer Cables
10. Oversized Cable Sheave Diameter Reduces Cable Fatigue
11. ASARS - Withstand Over 2000 lbs. of Side Force
12. Power Side Post Supports
 - Power Unit
 - Lowering Handle
 - Safety Lock Release Handle

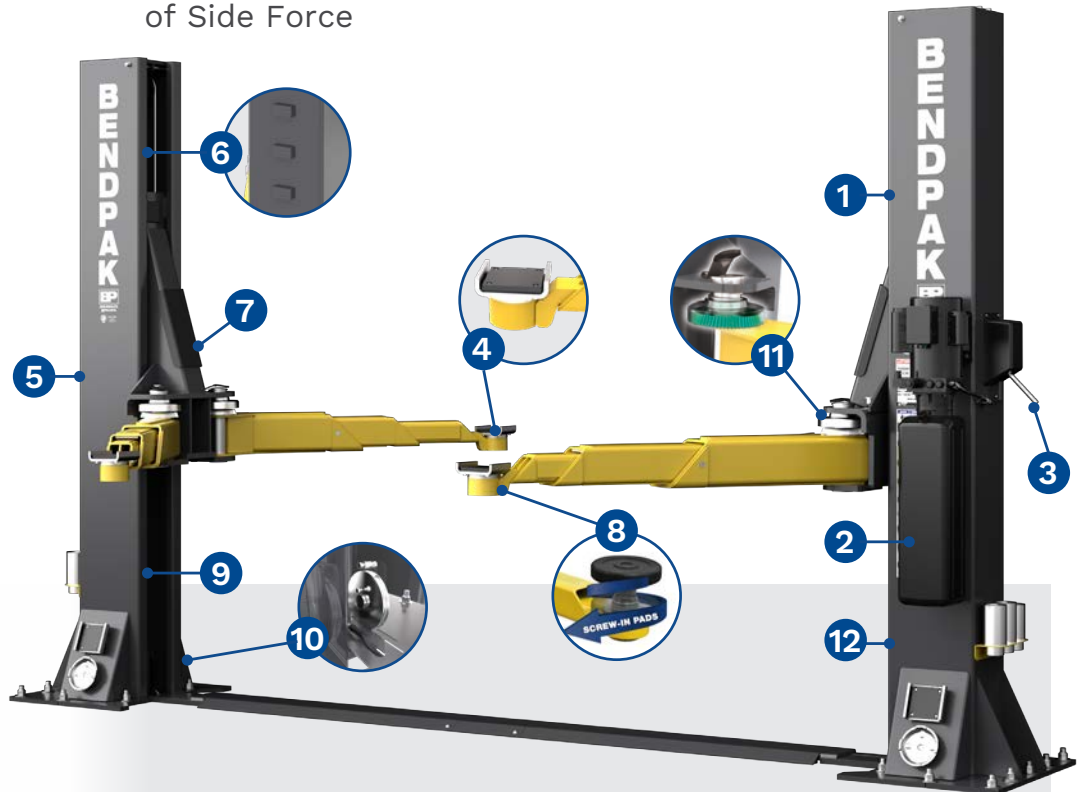

ADAPTABLE DESIGN: SYMMETRIC OR ASYMMETRIC

BendPak

PRODUCT DETAIL







The Perfect Lift For Tire and Wheel Service

The compact design of the 12AP-SRT makes it the lift of choice when you're performing tasks that don't require you to stand underneath a vehicle. With a max rise of roughly 46 inches, this lift is ideal for tire service as well as detailing.

A New Paradigm In Lifting

The AP Series features an innovative design which combines the best attributes of today's two-post lifts and combines it into a completely fresh approach to car lift engineering. The final result is a lift unlike any other on the market, built to handle tough jobs, heavy loads, and ensure the safety of the vehicle and the operator. BendPak's double-telescoping screw adapters are designed with precision and safety in mind. Featuring durable polyurethane pads that resist gouging and tearing. These adapters can be easily adjusted up or down to ensure level lifting, even in challenging conditions. For added versatility, there are the optional 2.5" and 5" stackable adapters that provide precise and secure support for vehicles. Their convenient drop-in design allows for quick and effortless use, while a column-mounted rack keeps these adapters neatly organized and secure, streamlining your workflow.

ADAPTERS

ADAPTERS		ADAPTERS	
	2.25" Small Adapters (Set of 4) 5215757		Screw Pads* (Set of 4) 5215762
	2.5" Medium Adapters** (Set of 4) 5215758		Drop-In Cradle Pads** (Set of 4) 5215761
	5" Tall Adapters** (Set of 4) 5215759		Drop-In Steel Pads (Set of 4) 5215763
	Adapter Holders Standard on both models 5701660	Standard Package Included with 10AP-SRT* Included with 12AP-SRT**	

PRODUCT DETAIL

Unparalleled Safety with Automatic Arm Restraint

Traditional swing arm restraints serve their purpose, but BendPak takes safety to the next level. The AP Series introduces the revolutionary Automatic Swing Arm Restraint System (ASARS) that stands strong against the forces exerted when vehicles unexpectedly shift during loading or service. This adaptive system boasts a heavily forged-steel design, providing over 2,000 pounds of load-holding force. With a 360-degree grip, this patented arm restraint system ensures arms stay firmly in place, minimizing unplanned swing arm movement. The system's quick-release operator lever guarantees precise and secure control.

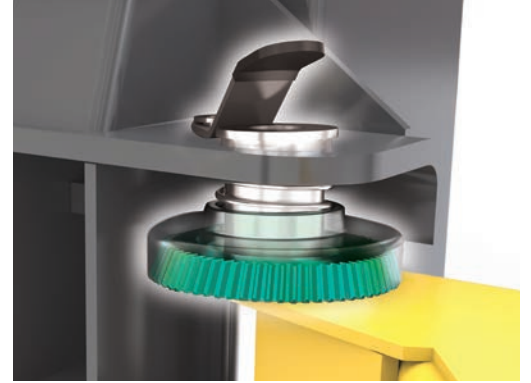

The Future Is Triple-Telescoping

Innovative and patented triple-telescoping swing arms redefine lifting precision. Unlike traditional arms, the AP arms retract shorter and extend farther, offering versatile arm positioning options for lift operators. The unique three-stage design, complete with a patented nesting feature, enables greater retraction and extension. Inner sliding arm movement reaches new levels without any hindrance, allowing for precise lifting action with increased efficiency.

Bi-Metric Swing Arms

Exclusive Bi-Metric adaptable swing-arms give users the ability to set their lift up in either symmetric or asymmetric configurations. The 2-in-1 design operators the option of loading vehicles either symmetrically (centerline of vehicle at column) or asymmetrically (centerline of vehicle behind column). By not having to switch out arms, you'll be able to service vehicles faster than ever before.

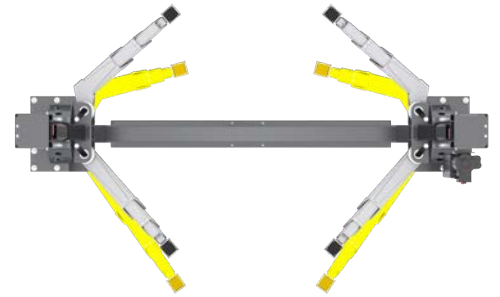

Innovative Safety Lock System

BendPak's patented automatic safety lock system is a game-changer for operator efficiency and safety. Its innovative design ensures that safety locks automatically engage during all lift rising operations, providing a reliable layer of protection. But what truly sets it apart is the user-friendly experience it offers. With an ergonomic single-point release mechanism, operators can effortlessly disengage the safety locks during lift descent. It's that simple, making your operations smoother and safer than ever before.

SPECIFICATIONS

Model	10AP-SRT	12AP-SRT
SKU	5595752	5595757
Lifting Capacity	10,000 lbs. / 4,536 kg	12,000 lbs. / 5,443 kg
Maximum Capacity – Front Axle	5,000 lbs. / 2,268 kg	6,000 / 2,721.5 kg
Maximum Capacity – Rear Axle	5,000 lbs. / 2,268 kg	6,000 / 2,721.5 kg
A – Width Overall (Narrow)	136 in. / 3,453 mm	155 in. / 3,937 mm
A – Width Overall (Wide)	146 in. / 3,707 mm	
B – Base Plate Width	25.25 in. / 642 mm	26.5 in. / 674 mm
C – Post Height	93.5 in. / 2,377 mm	93.5 in. 2,377 mm
D – Drive-Thru (Narrow)	91 in. / 2,311.5 mm	102.25 / 2598 mm
D – Drive-Thru (Wide)	101 in. / 2,565 mm	
E – Inside Posts (Narrow)	108.25 in. / 2,749 mm	119.25 in. / 3,026 mm
E – Inside Posts (Wide)	118.25 in. / 3,003 mm	
F – Outside Posts (Narrow)	129.5 in. / 3,289 mm	141.75 in. / 3,600 mm
F – Outside Posts (Wide)	139.5 in. / 3,543 mm	
G – Minimum Height w/ Pad	4.5 in. / 116 mm	4.25 in. / 105 mm
H – Max. Lifting Height	46.25 in. / 1,174.75 mm	46.25 in. / 1,174.75 mm
I – Max. Rise	42.5 in. / 1,081 mm	42.75 in. / 1,089 mm
J – Max. Screw Pad Adjustment	2.25 in. / 55mm	Not Applicable
J – Min. Height w/ Adapters (5 in. + 2.5 in.)	Not Applicable	11.75 in. / 298 mm
K – Floor Plate Height	1.4 in. / 36 mm	1.5 in. / 38 mm
L – Floor Plate Width	9.5 in. / 240 mm	
M – Front Arm Reach	22.25 in. Min – 47.5 in. Max. / 562 mm Min. – 1,205 mm Max.	26 in. min – 55.25 in. Max. / 659 mm Min. – 1,403 mm Max.
N – Rear Arm Reach	29.5 in. Min. – 57 in. Max. / 747 mm – 1,446 mm Max.	29.25 in. Min. – 60 in. Max. / 745 mm – 1,525 mm Max.
Safety Lock Positions	8	
Standard Motor*	220 VAC, 60 Hz, 1 Phase	
Time to Full Rise	~45 seconds	
Sound	<43dB	
Operating Hydraulic Pressure Under Max. Load	2,170 psi	

Please note that the 12AP-SRT ships with square frame-engaging lift pads whereas the 10AP-SRT features circular pads. When using the lift with an Adapter (See Fig. M), the max lifting height increases by roughly 7 inches. Specifications subject to change without notice. Photos and diagrams are shown for illustrative purposes only. BendPak makes no warranty, representation, or guarantee regarding the information contained herein or the suitability this equipment for any particular purpose. Always refer to the operator's manual for detailed instructions on the proper use and maintenance.

SPECIFICATIONS

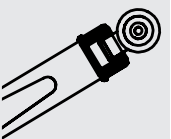

10AP-SRT LIFT
Ships with circular pads

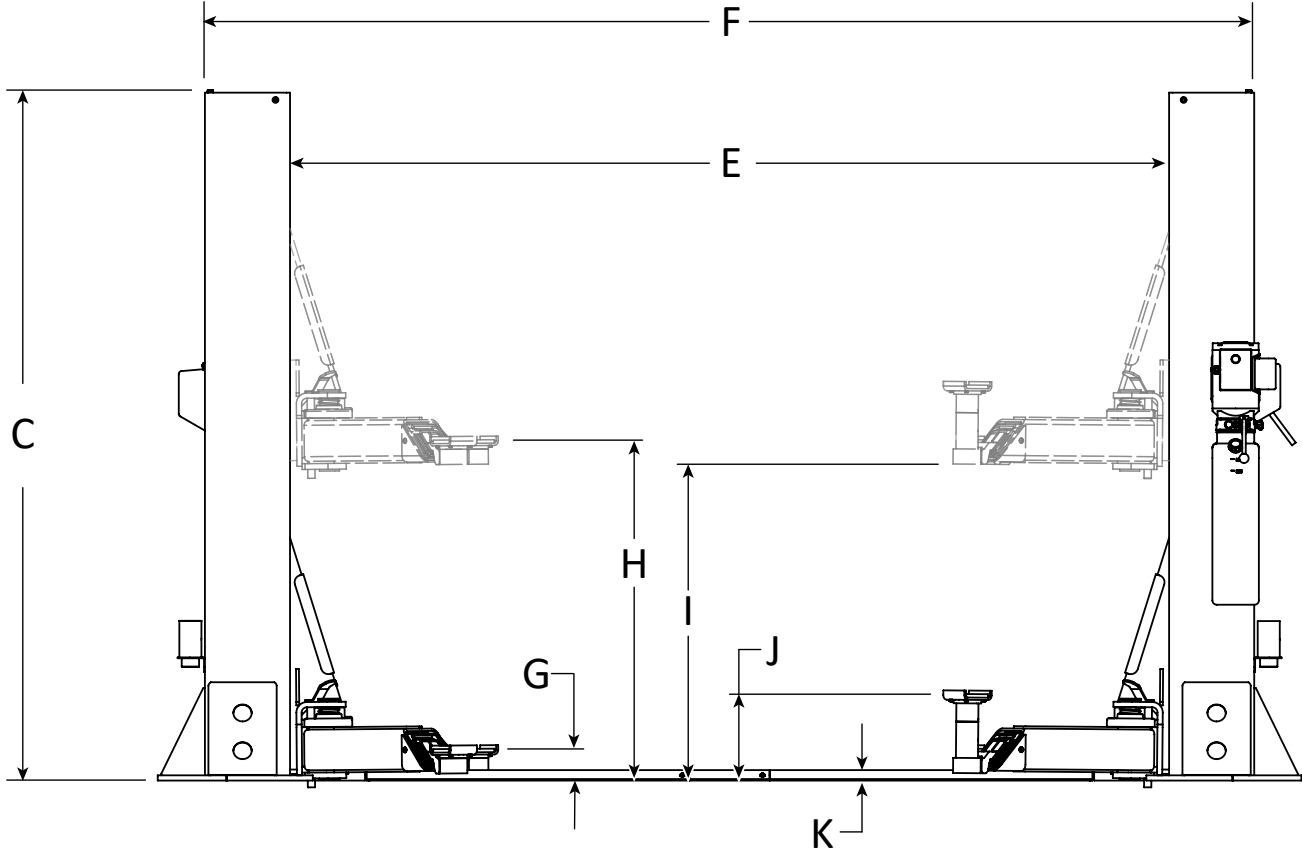
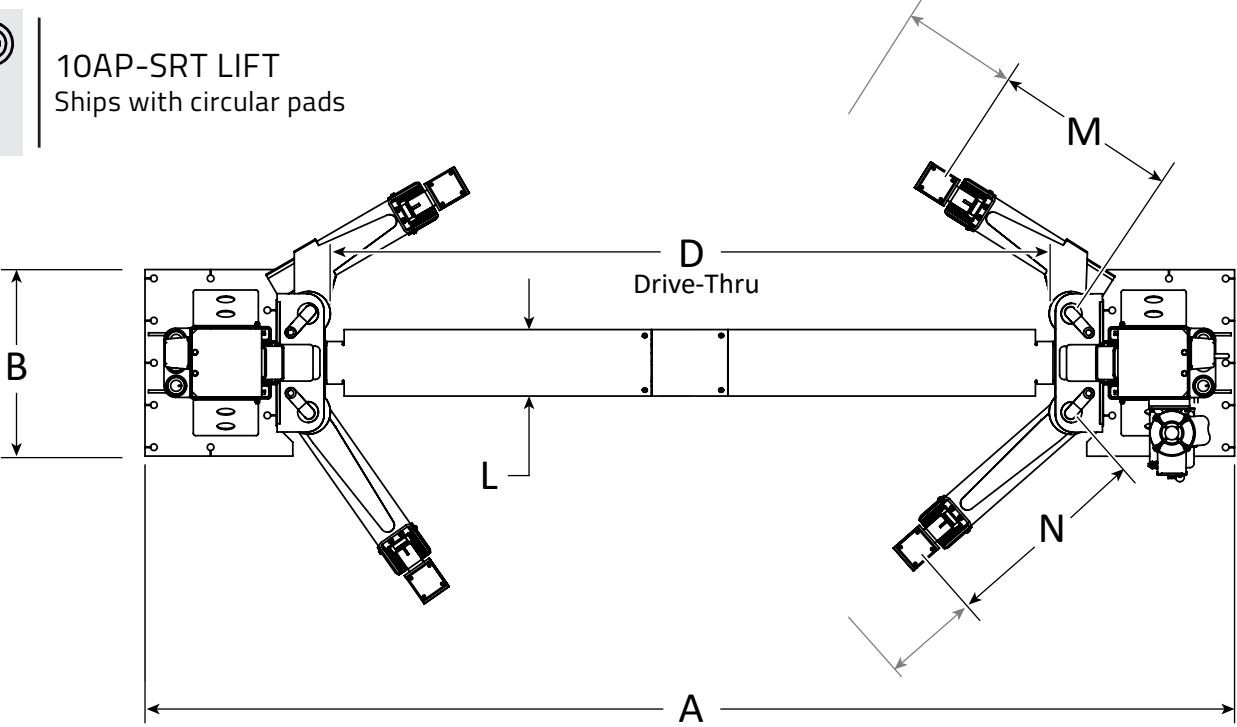

ADAPTABLE DESIGN: SYMMETRIC OR ASYMMETRIC

